

Motorized respiratory system CleanAIR®



Export Price List 2012

(EXW prices in EUR are valid from 01.01. 2012)



MALINA-Safety s.r.o., Luční 11, 466 01 Jablonec n.N., Tel: +420 483 356 631, Fax: +420 483 312 106
E-mail: export@malina-safety.cz
www.malina-safety.com

CleanAIR Products combinations

		Basic 2000 DF/FC	Chemical 2F	Chemical 3F	CA Chemical DF	Pressure / Pressure FC	Pressure for mask	Asbest
								
		EN 12941	EN12941 EN12942	EN12941 EN12942	EN12941 EN12942	EN14594	EN14594	EN12942
CA - 1		TH1/TH2	TH2	TH2	TH1	2A		
CA - 2		TH1/TH2	TH2	TH2	TH1	2A		
CA - 3		TH1/TH2	TH2	TH2	TH1	2A		
CA - 4		TH1/TH2	TH2	TH2	TH1	2A		
CA - 5			TM2	TM2				
CA - 6			TM3	TM3	TM1		4B	TM3
CA - 6 + filter			TM3					
CA - 10		TH1/TH3	TH3	TH3				
CA - 20		TH1/TH3	TH3	TH3		2A		
CA - 22		TH1/TH2	TH2	TH2	TH1	2A		
CA - 40		TH1/TH2	TH2	TH2		2A		

Hoses Combinations





Unit type	Hose type			Type	CA-1	CA-2	CA-3	CA-4	CA-6	CA-5	CA-10	CA-20	CA-22	CA-40	
	Unit end	Headtop end	Type												
			Light flexi	70 00 60	70 00 60			70 00 60	70 00 60	70 00 60	70 00 60	70 00 60	70 00 60	70 00 60	
			Heavy flexi			70 00 82CA	70 00 82CA	70 00 82CA	70 00 82CA	70 00 82CA			70 00 82CA	70 00 82CA	70 00 82CA
			Rubber								70 00 86CA	70 00 86CA			
			Light flexi 25°												
			Rubber 25°							70 00 86Q	70 00 86Q				
			Rubber 90°							70 00 86R	70 00 86R				
			Light flexi	70 00 60B	70 00 60B	70 00 60B	70 00 60B	70 00 60B		70 00 60B	70 00 60B	70 00 60B	70 00 60B	70 00 60B	
			Heavy flexi			70 00 82B	70 00 82B	70 00 82B	70 00 82B						70 00 82B
			Rubber							70 00 86B	70 00 86B				
			Light flexi 25°						70 00 86BQ	70 00 86BQ					
			Rubber												
			Rubber 90°												
			Light flexi												
			Heavy flexi												
			Rubber												
			Light flexi	70 00 60	70 00 60	70 00 60	70 00 60	70 00 60							
			Heavy flexi			70 00 82CA	70 00 82CA	70 00 82CA	70 00 82CA						
			Rubber			70 00 86CA	70 00 86CA	70 00 86CA	70 00 86CA						
			Light flexi												
			Heavy flexi												
			Rubber												
			Light flexi												
			Heavy flexi												
			Rubber												
			Light flexi												
			Heavy flexi												
			Rubber												
			Light flexi												
			Heavy flexi												
			Rubber												
			Light flexi												
			Heavy flexi												
			Rubber												





* To connect old Chemical and CA Basic 2000 units with old head tops please use a hose 70 00 60BB (bayonets)

Recommended hose

CleanAIR Basic 2000



CleanAIR Basic 2000 Dual	Flow indicator	Comfort belt Standard	Comfort belt Super	Battery charger	Price EUR
	70 00 90	71 00 93	71 00 92	70 00 30	
					
80 00 00X	.				303,40
80 00 00XPA	.	.		.	361,60
80 00 00XCA	.		.	.	371,80
Ord. no. + U	Set with UK charger				

CleanAIR Basic 2000 Flow Control	Flow indicator	Comfort belt Standard	Comfort belt Super	Battery charger	Price EUR
	70 00 90	71 00 93	71 00 92	70 00 30	
					
82 00 00	.				347,20
82 00 00PA	.	.		.	411,50
82 00 00CA	.		.	.	421,80
Ord. no. + U	Set with UK charger				

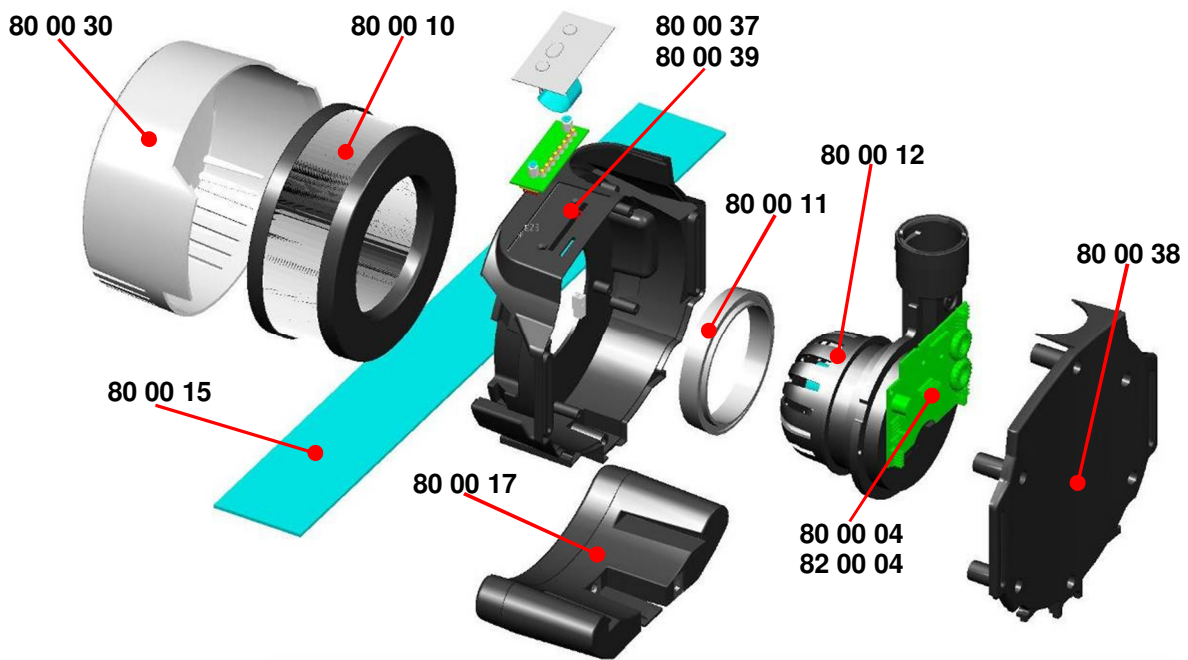

CleanAIR BASIC 2000 spare parts





80 00 11	Sealing ring for filter 80 00 10	2,88
80 00 12	Motor cover	7,11
80 00 30	Filter cover for CleanAIR BASIC 2000	7,42
80 00 37	Central plate moulding with keyboard for CleanAIR BASIC 2000 Dual Flow	21,22
80 00 38	Back plate moulding for CleanAIR BASIC 2000	3,81
80 00 39	Central plate moulding with LED panel and keyboard for CleanAIR BASIC 2000 Flow Control	32,24
82 00 02	Keyboard for CleanAir BASIC Flow Control	14,73

CleanAIR BASIC 2000 accesories

	70 00 30 70 00 31	Battery charger EURO plug Battery charger UK plug	44,29
	70 00 60B	Light flexi hose CA40x1/7" - bayonet	28,12
	70 00 82B	Heavy flexi hose CA40x1/7" - bayonet	52,63
	70 00 86B	Rubber hose CA40x1/7" - bayonet	51,29
	70 00 60BQ	Light flexi hose CA40x1/7" 25° - bayonet	28,12
	71 00 93	Comfort belt Standard	20,29
	71 00 92	Comfort belt Super	30,49
	70 00 90	Flow indicator (bayonet)	5,46
	80 00 17	Exchangeable battery pack NiMH 4,8V/4,5Ah	140,80
	80 00 10/2	Filter PSL for CA BASIC 2000 (pack of 2 pcs)	25,96
	80 00 10/20	Filter PSL for CA BASIC 2000 (pack of 20 pcs)	259,56
	80 00 15	Pre-filter for CleanAIR BASIC 2000 (pack of 10pcs)	7,00
	80 00 20	Odour filter for CleanAIR BASIC 2000 (pack of 10pcs)	10,60





CleanAIR Chemical 3F

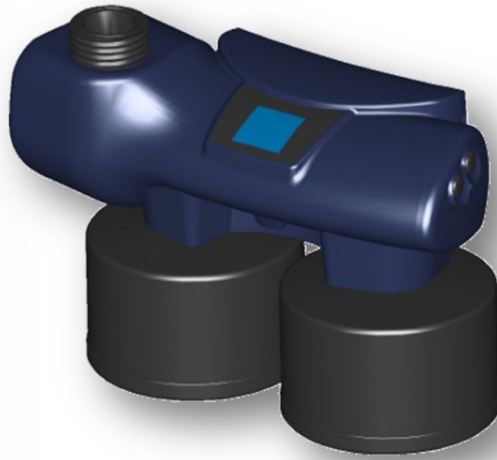

CleanAIR Chemical 3F	Flow indicator	Comfort belt 3F	Decont. Belt	Battery charger	Price EUR
	70 00 90RD 	52 00 43.1 	51 00 40 	51 00 30 	
52 00 00	•				517,58
52 00 00FCA	•	•		•	646,43
52 00 00FDA	•		•	•	635,92
Order no. + U	Battery charger with UK plug				

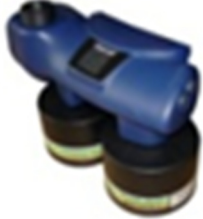
CleanAIR Chemical 2F





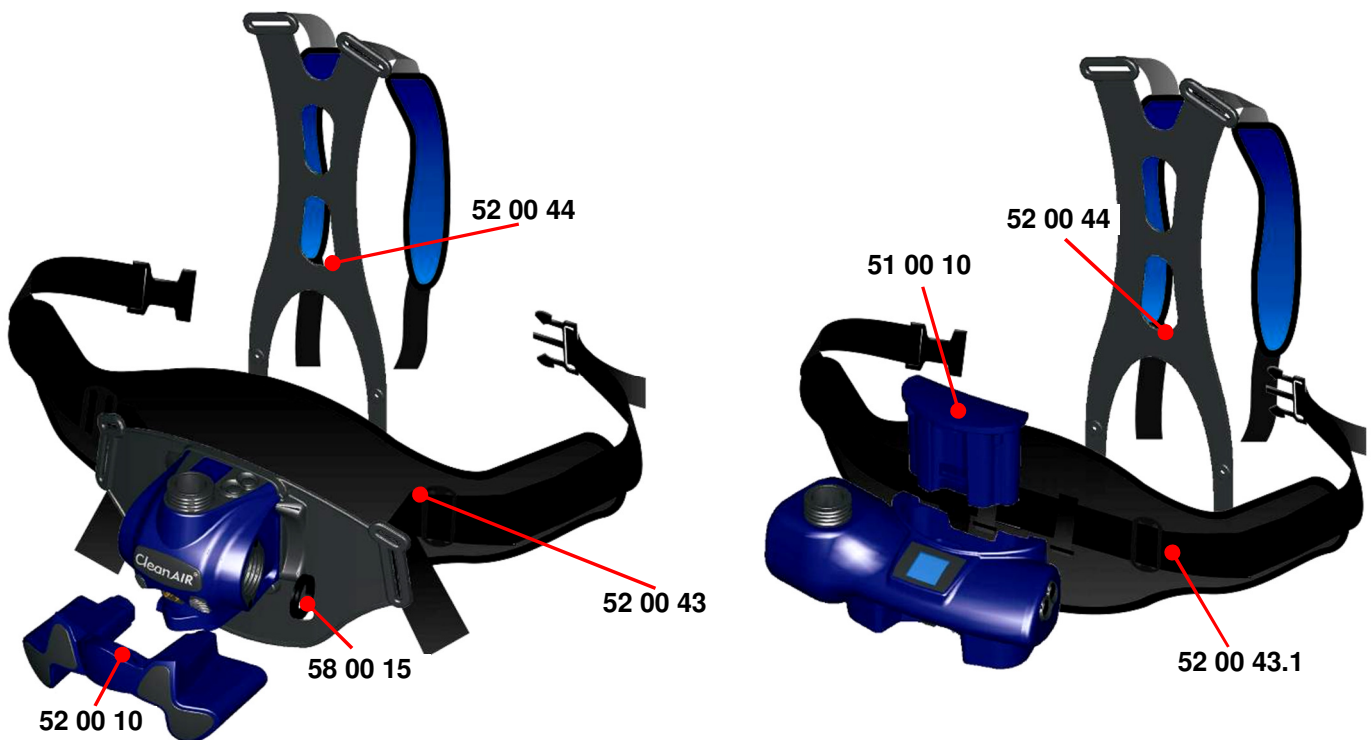

CleanAIR Chemical 2F	Flow indicator	Comfort belt 2F	Decont. Belt	Battery charger	Price EUR
	70 00 90RD 	71 00 92 	51 00 40 	51 00 30 	
51 00 00	•				530,76
51 00 00FCA	•	•		•	659,61
51 00 00FDA	•		•	•	649,11
Order no. + U	Battery charger with UK plug				





CleanAIR Chemical 2F and 3F accessories and spare parts











CleanAIR Chemical 3F spare parts

	52 00 10	3F exchangeable battery Li-ion 14,4 V/2,6 Ah	174,89
	52 00 43.1	3F Belt comfort (NEW)	30,18
	52 00 44.1	Comfort padded harness	39,96
	52 00 41	Decontaminable harness	43,47
	51 00 30EUR 51 00 30UK	Charger Li-ION 14,4 V EURO Charger Li-ION 14,4 V UK	93,22
	58 00 15	Sealing ring 37x25x6	0.95
	52 01 01	2F/3F TFT Display foil	2.00

CleanAIR Chemical 2F spare parts





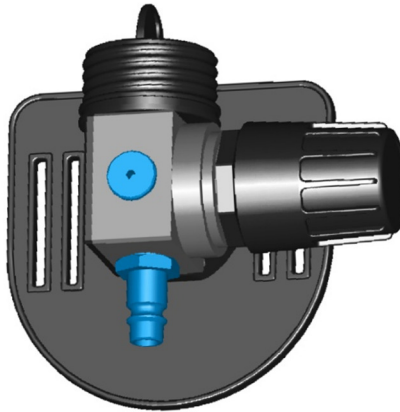

	51 00 10	2F exchangeable battery Li-ion 14,4 V/2,6 Ah	165,01
	71 00 92	2F Belt comfort (NEW)	30,18
	52 00 43.1	3F Belt comfort (NEW)	
	52 00 44.1	Comfort padded harness	39,96
	52 00 41	Decontaminable harness	43,47
	51 00 30EUR	Charger Li-ION 14,4 V EURO	93,22
	51 00 30UK	Charger Li-ION 14,4 V UK	
52 01 01		2F/3F TFT Display foil	2,00

CleanAIR Chemical 2F and 3F accessories

	70 00 60	Light flexi hose CA40x1/7" - CA40x1/7"	28,12
	70 00 60Q	Light flexi hose CA40x1/7" - CA40x1/7" 25°	28,12
	70 00 82CA	Heavy flexi hose CA40x1/7" - CA40x1/7"	52,63
	70 00 86CA	Rubber hose CA40x1/7" - CA40x1/7"	51,29
	70 00 86Q	Rubber hose CA40x1/7" - CA40x1/7" 25°	51,29
	70 00 86R	Rubber hose CA40x1/7" - CA40x1/7" 90°	51,29
	51 00 40	Belt decontaminable 50	19,67
	57 00 20	Belt rubber 50	11,02
	70 00 62F	Hose cover flameproof	19,06
	70 00 62C	Hose cover chemical resistant	19,06
	58 00 13	Rubber filter cover	3,50
	50 02 48	Filter P3 - with two RD40 threads	11,85
	70 00 90RD	Flow indicator, RD40x1/7"	6,80











CleanAIR Pressure



	CA Pressure				
			70 00 95	70 00 90RD	
63 00 00	CA Pressure - unit with belt and flow indicator	•	•		113,61
	CA Pressure Flow Control				
64 00 00	CA Pressure Flow Control – unit with belt and flow indicator	•	•		151,20
63 00 10	Noise silencer				9,06
63 00 20	Control valve				36,77
60 00 43	Pressure air fitting				10,50





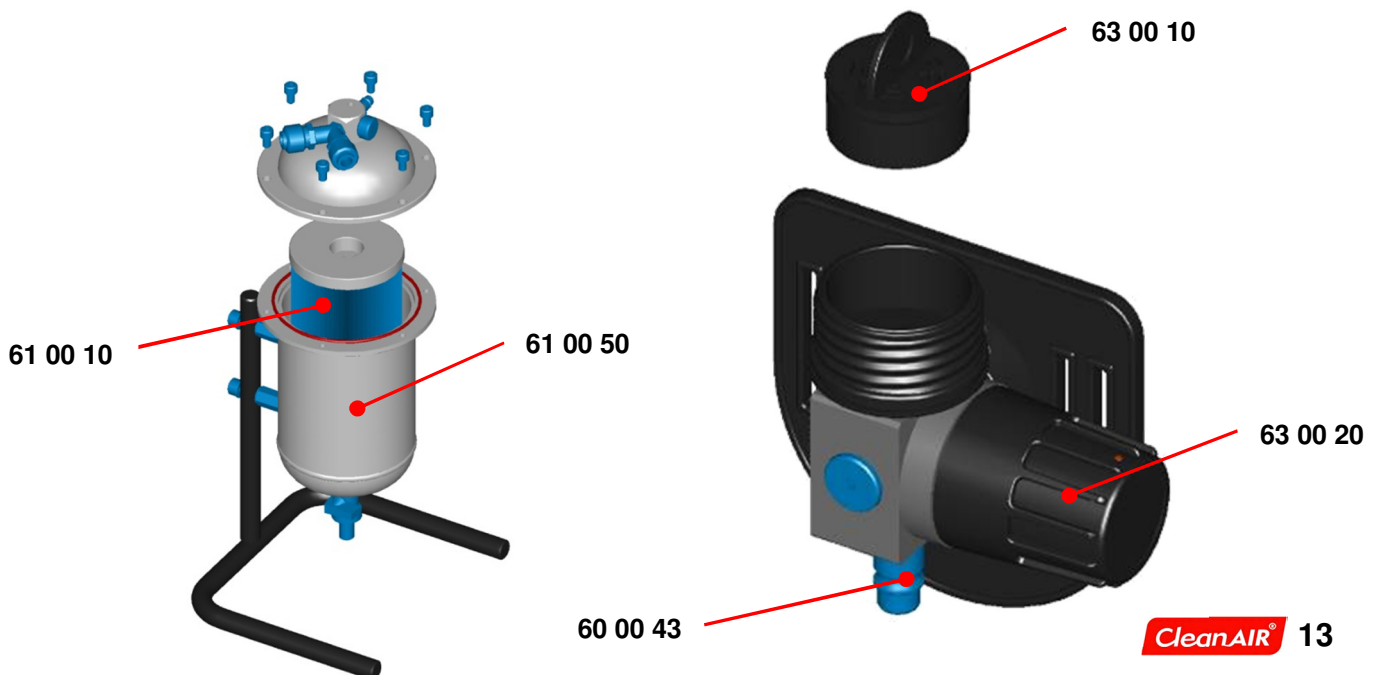

CA Pressure unit will be offered with our CA40 thread from 2012.

CleanAIR Pressure accessories

	70 00 60	Light flexi hose CA40x1/7" - CA40x1/7"	28,12
	70 00 86CA	Rubber hose CA40x1/7" - CA40x1/7"	51,29
	70 00 82CA	Heavy flexi hose CA40x1/7" - CA40x1/7"	52,63
	70 00 95	Belt for CA Pressure	8,76
	70 00 90RD	Flow indicator, RD40x1/7"	6,80
	61 00 50	CleanAIR Pressure Conditioner - filter incl.	321,88
	61 00 10	Filter for CA Pressure Conditioner	49,03
	61 00 36	Spiral pressure hose CAP 10m	59,95
	61 00 30	Standard pressure hose CAP 10m	39,55
	61 00 31	Antistatic pressure hose CAP 10m	84,98



CleanAIR Pressure for Mask

	65 00 00P	CA Pressure for mask - complete set + 1 filter, w/o fullface mask!	139,98
	65 00 10	CA Pressure for mask - mask reduction + 1 filter (50 02 48)	41,75
	65 00 00W	CA Pressure for mask - unit only	111,34
	61 00 30	Standard pressure hose CAP 10m	39,55
	61 00 31	Antistatic pressure hose CAP 10m	82,50
	61 00 38	Standard pressure hose CAP 25m	77,77
	61 00 33	Antistatic pressure hose CAP 25m	175,50
	61 00 39	Standard pressure hose CAP 50m	136,27
	61 00 34	Antistatic pressure hose CAP 50m	328,50
	50 02 48	Filter P3 - with two RD40 threads	11,85



CleanAIR Asbest



59 06 00	CleanAIR Asbest incl. 2 pcs batteries ,filter,hose with keeper,battery charger EURO , rubber belt, flow indicator and fullface mask Sundström SR 200	618,84
59 06 00U	CleanAIR Asbest incl. 2 pcs batteries ,filter,hose with keeper,battery charger UK , rubber belt, flow indicator and fullface mask Sundström SR 200	
59 00 02	CleanAIR Asbest incl.battery,filter,hose with keeper, battery charger EURO, rubber belt, flow indicator. w/o fullface mask!	370,28
59 00 02U	CleanAIR Asbest incl.battery,filter,hose with keeper, battery charger UK, rubber belt, flow indicator. w/o fullface mask!	
59 00 01	CleanAIR Asbest incl.battery,without filter	266,35
59 00 00	CleanAIR Asbest without battery and filter	149,14



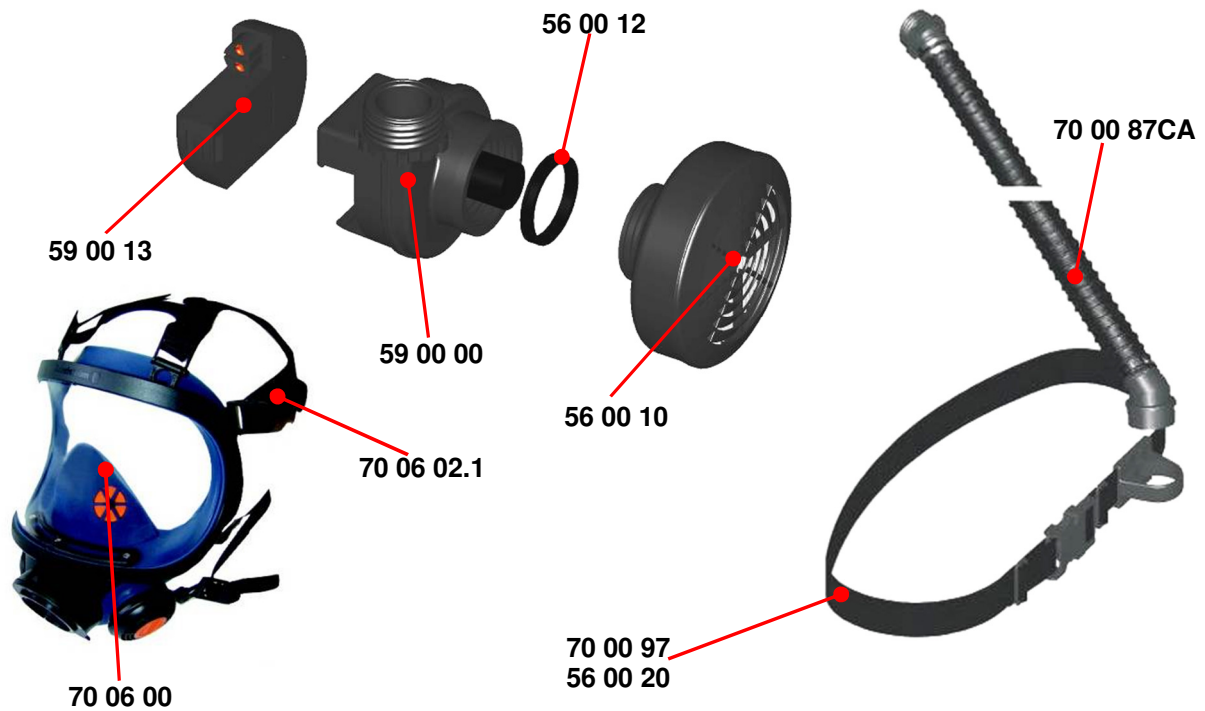

CleanAIR Asbest accessories







56 00 10	Filter PSL for CleanAIR Asbest	9,48
50 01 08	Canister filter cover	2,16
56 00 12	Filter sealing ring 45x39x6	3,71
59 00 13	Exchangeable battery for CA Asbest-Li-Ion 7,2V/2,2Ah	117,11
56 00 20	Rubber belt with hose and unit keeper complete	43,57
70 00 87CA	Light flexi hose - CA Asbest	28,12
59 00 90RD	Flow indicator, connector RD40	6,80
70 00 97	Belt for CleanAIR Asbest	9,99
59 00 30	CleanAIR Asbest Li-Ion charger	62,93
59 00 30U	CleanAIR Asbest Li-Ion charger UK	
70 06 00	Full face mask CA-6 (Sundström SR200)	190,-
70 06 01	SR200 Visor polycarbonate	67,-
70 06 02.1	SR200 Head harness rubber, toothed	25,65
70 06 05	SR 200 Set of membranes	23,-
70 06 06	SR 200 Seal for filter connection	4,31,-
70 06 20	SR200 Protection plate (pack of 10pcs)	17,90,-

CleanAIR Chemical Dual Flow



CA Chemical DF				Price EUR
	70 00 92 Comfort belt Super	70 00 35 Battery charger EURO plug	70 00 90 Flow indicator	
50 00 00			•	317,55
50 00 00PA	•	•	•	404,38
Ord. no. + U	Battery charger with UK plug			

CleanAIR Chemical Dual Flow accessories and spare parts

	70 00 35	Battery charger EURO plug	56,55
	70 00 36	Battery charger UK plug	
	70 00 60B	Light flexi hose CA40x1/7" - bayonet	28,12
	70 00 82B	Heavy flexi hose CA40x1/7" - bayonet	52,63
	70 00 86B	Rubber hose CA40x1/7" - bayonet	51,29
	70 00 92	Comfort belt Super	30,49
	70 00 99C	Plastic belt clips	4,12
	70 00 90	Flow indicator	5,46
	50 00 02	Keyboard for CleanAIR Chemical Dual Flow	12,05
	50 00 04	Fan for CleanAIR Chemical with Dual flow electronics	151,2
	50 00 35	Back cover	4,64
	50 00 50	Locking ring (set of 3 pcs)	1,03
	70 00 19	Exchangeable battery NiMH 6V/4,5 Ah	195,39

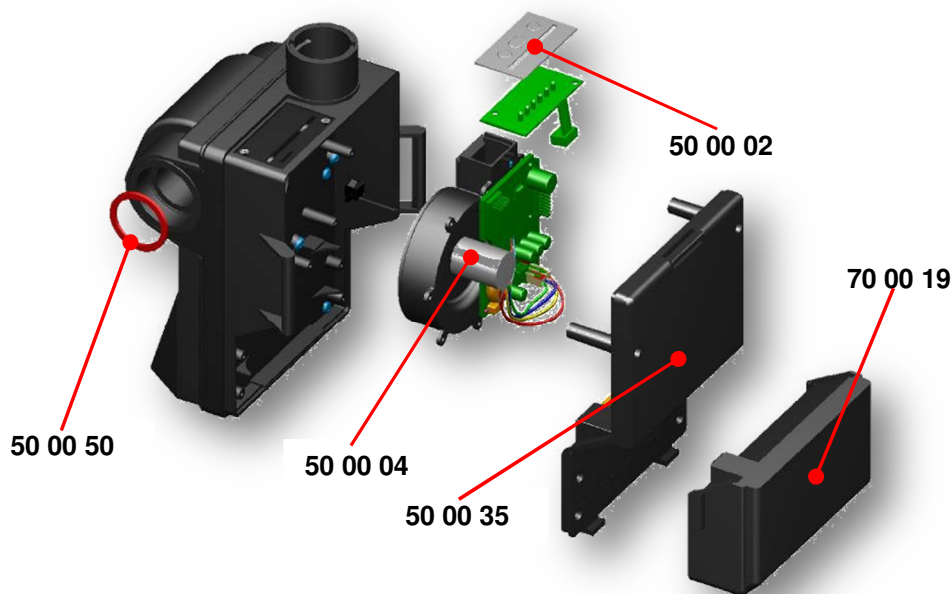

Light hoods CA - 1, CA - 2, CA - 10

71 01 00	Short hood CA-1 orange	51,19
71 01 00B	Short hood CA-1 blue	
71 02 00	Long hood CA-2 orange	65,41
71 02 00B	Long hood CA-2 blue	
71 02 00G	Long hood CA-2 Chemical resistant (grey Tychem)	78,28
71 10 00	Universal hood CA-10 orange	74,68
71 10 00B	Universal hood CA-10 blue	
71 10 00G	Universal hood CA-10 Chem. resistant (grey Tychem)	88,58
70 01 20	Protection plate self-adhesive for hoods CA-1,2 and 10 (pack of 10pcs)	16,60
70 02 01	Tyvek head protection	4,02
71 01 10	Winter cap + 1 additional sweatband	8,76
16 70 01	Sweatband	1,13

71 01 00



71 02 00



71 10 00



71 01 10



Grinding Visor CA – 3



71 03 00	Grinding visor CA-3 (polycarbonate)	121,03
71 03 01	Protective visor CA-3 (acetate)	123,70
71 03 30	CA-3 Spare visor polycarbonate	17,30
71 03 33	CA-3 Spare visor acetate	19,98
71 03 41	CA-3 Headband	18,03
70 21 53	Face seal for welding hoods - universal	14,73
71 03 20	Protection plate self-adhesive for CA-3 (pack of 10pcs)	16,60
16 70 01	Sweatband	1,13
71 04 50CA	Air duct - CA40 thread	37,90

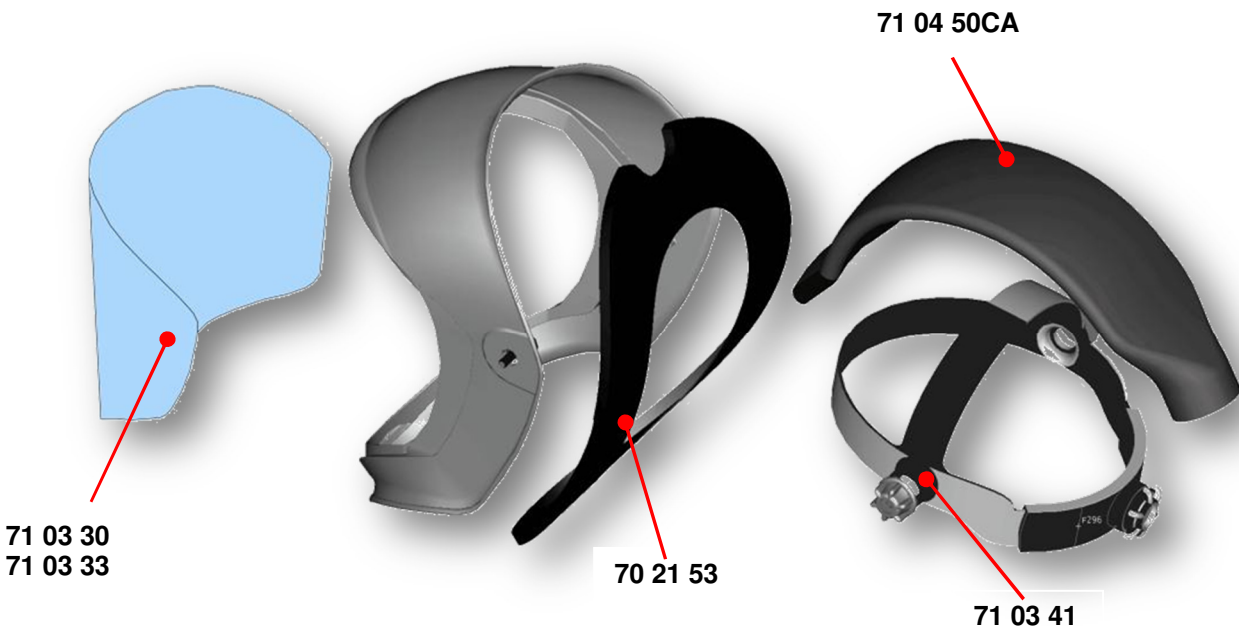

Safety helmet CA - 4



71 04 01	Safety helmet CA-4 with breathing system (orange face seal) NEW	108,36
71 04 01B	Safety helmet CA-4 with breathing system (blue face seal) NEW	
71 04 00V	Safety helmet CA-4 PLUS with breathing system (<u>LONG face seal orange</u>) NEW	112,68
71 04 03 *	Safety helmet CA-4 with breathing system, ear muffs and impact visor (orange face seal) NEW	187,56

70 01 20	Protective plate self-adhesive (pack of 10pcs)	16,58
71 04 61	Face seal incl. visor, colour orange, with exhalation valve	36,67
71 04 61B	Face seal incl. visor, colour blue, with exhalation valve	36,67
71 04 62	Long face seal incl. visor, orange	41,10
70 04 37	Holder of the impact visor for the helmet CA-4	16,89
70 04 40.1	Ear muffs with attachment for the helmet CA-4	37,49
70 04 41	Headband for the helmet CA-4	18,23
70 03 20	Protective plate for old CA-3 (pack of 10 pcs.) – fits also to the CA-4	1,65
70 04 42	Visor for safety helmet Polycarbonate	23,59
70 04 33	Visor for safety helmet Acetate	31,93

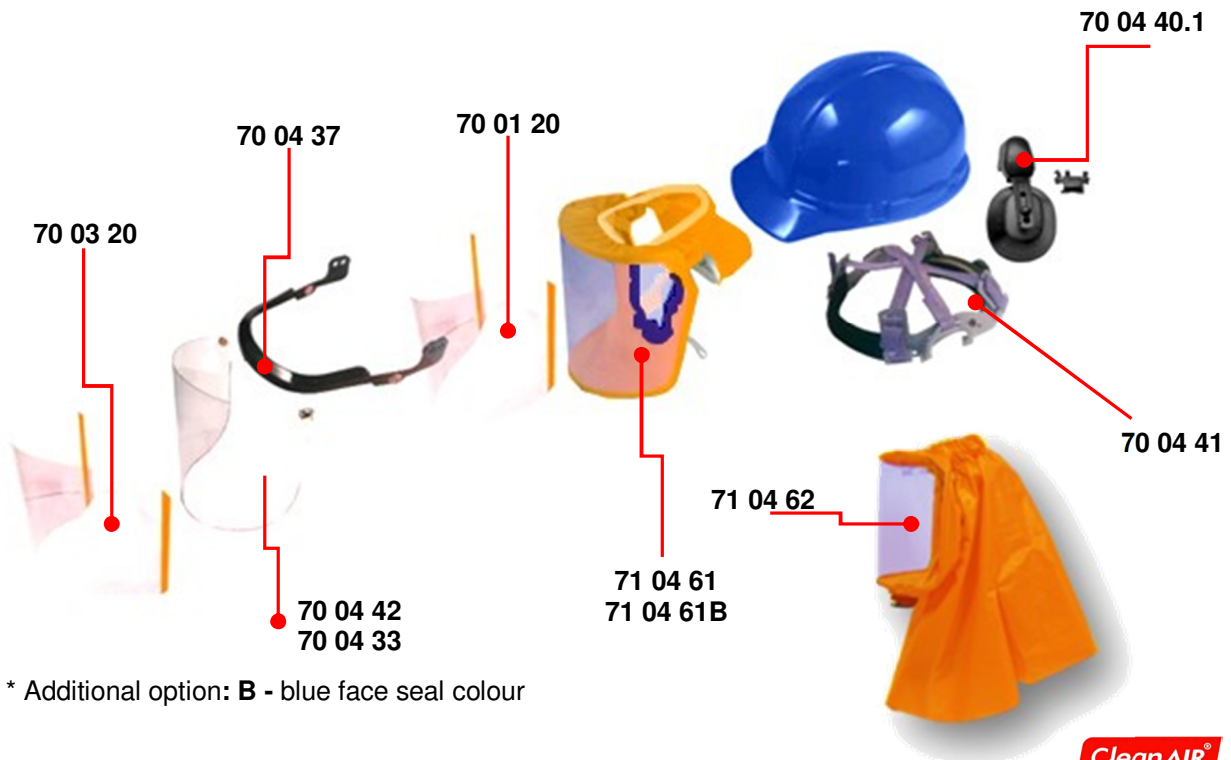

* Additional option: **B** - blue face seal colour

Halfmask CA – 5



70 05 00	Halfmask CA-5 Eurmask DIN	36,05
70 05 01	Elastic bands (2 pcs.)	3,71
70 05 02	Buckles	2,78
70 05 03	Harness	3,71
70 05 04	Cap for exhalation valve	2,47
70 05 05	Threaded fitting	4,64
70 05 06	Fitting gasket	2,78
70 05 07	Inhaling valve	2,47
70 05 08	Exhalation valve	4,64

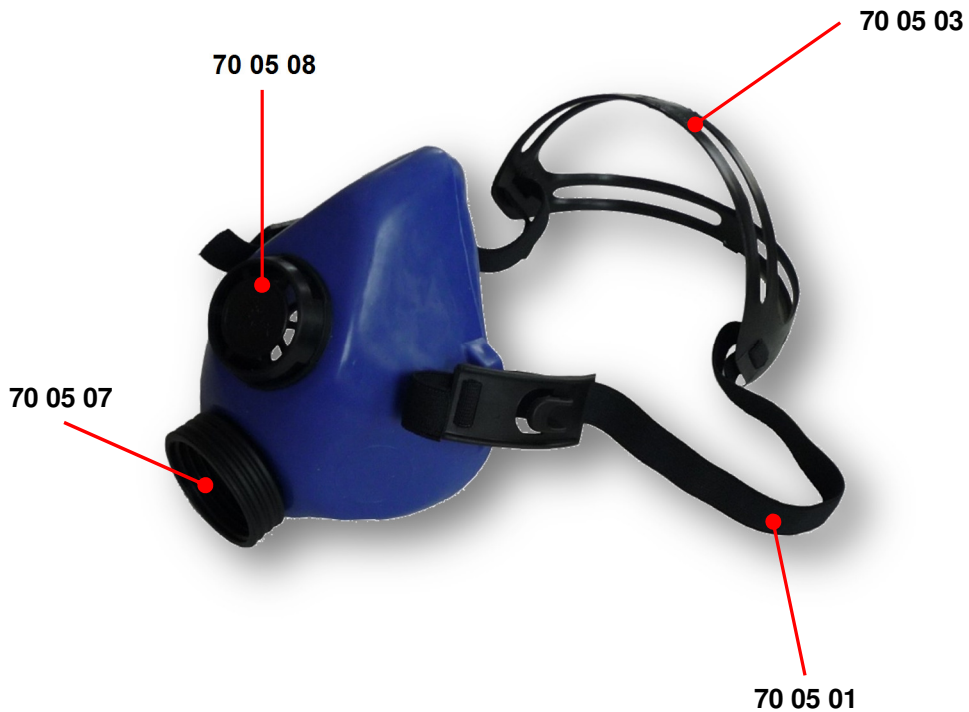

Welding hood CA - 20



70 20 97	Welding hood CA-20 w/o breathing system and ADF (for DS)	30,90
70 20 98	Welding hood CA-20 w/o breathing system and ADF (for GDS)	30,90
70 20 00	Welding hood CA-20 with breathing system – standard face seal (for DS)	132,87
70 20 00L	Welding hood CA-20 with breathing system – long face seal (for DS)	132,87
70 20 00F	Welding hood CA-20 with breathing system – flexi face seal (for DS)	132,87
70 20 01	Welding hood CA-20 with breathing system – standard face seal (for GDS)	132,87
70 20 01L	Welding hood CA-20 with breathing system – long face seal (for GDS)	132,87
70 20 01F	Welding hood CA-20 with breathing system – flexi face seal (for GDS)	132,87
70 20 70	Welding hood CA-20 with breathing system, Grand V9-13 DS – standard face seal	389,34
70 20 70L	Welding hood CA-20 with breathing system, Grand V9-13 DS – long face seal	389,34
70 20 70F	Welding hood CA-20 with breathing system, Grand V9-13 DS – flexi face seal	389,34
70 20 81	Welding hood CA-20 with breathing system, Grand V9-13 GDS – standard face seal	409,94
70 20 81L	Welding hood CA-20 with breathing system, Grand V9-13 GDS – long face seal	409,94
70 20 81F	Welding hood CA-20 with breathing system, Grand V9-13 GDS – flexi face seal	409,94
70 20 71	CA-20 Protection plate outside (pack of 10pcs)	12,40
70 20 73	CA-20 Protection plate inside, SHADE +1 , 107,5x71,5mm	4,12
70 20 72	CA-20 Protection plate inside 107x51 mm (pack of 10pcs)	8,20
70 20 60	Face seal for welding hood CA-20 - Standard	23,69
70 20 60F	Face seal for welding hood CA-20 - Flexi	23,69
70 20 60L	Face seal for welding hood CA-20 - Long	23,69
70 20 31	CA-20 yellow front frame	8,96
70 25 41	Headband for welding hood CA-20 - with two sweatbands	13,13
16 70 01	Sweatband	1,13
70 20 32	Hose holder	8,24
70 20 33	Sealing washers (1 pair)	4.12

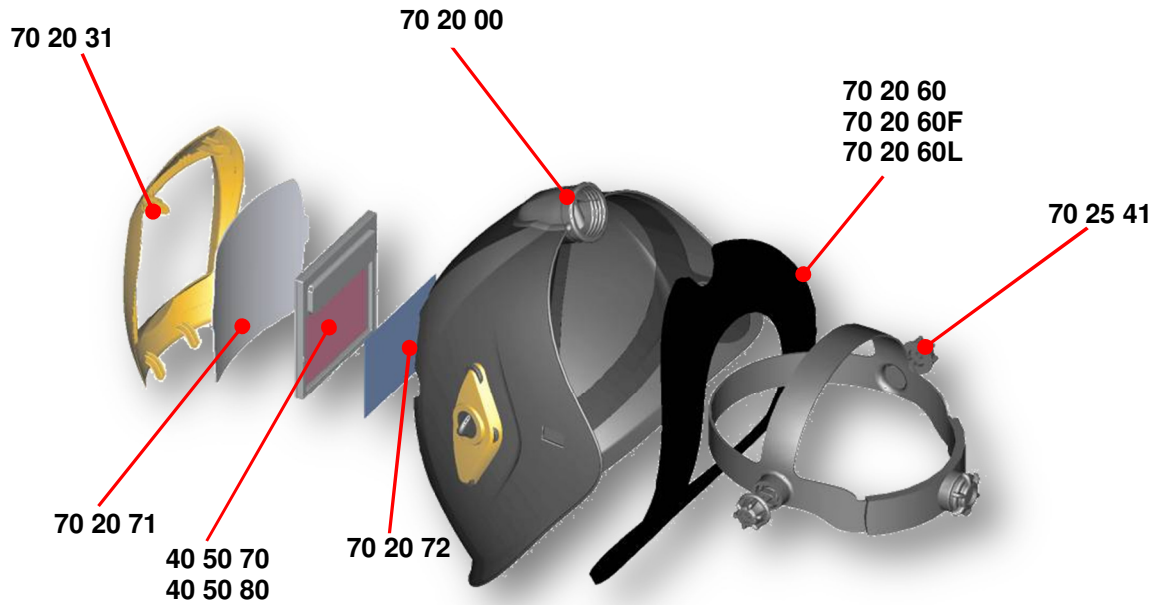

40 50 70	Autodarkening welding filter Grand V9-13 DS - ADC plus	256,47
40 50 80	Autodarkening welding filter Grand V9-13 GDS - ADC plus	277,07



40 50 70



40 50 80

Welding hood CA - 22



70 22 00	Welding hood CA-22 with headband, with breathing system, without ADF	180,35
70 22 40	Welding hood CA-22 with headband, with breathing system and ADF V913 DS adc	385,12
70 22 80	Protection plate polycarbonate - outside (pack of 10pcs)	14,21
70 22 81	Protection plate polycarbonate - inside (pack of 10pcs)	17,10
70 21 53	Face seal for welding hoods - universal	14,73
70 21 41	Headband for welding hood CA-21, CA-22 - with two sweatbands, w/o airduct	38,32
71 04 50CA	Air duct - CA40x1/7" thread	37,90
16 70 01	Sweatband	1,13
70 22 90	Welding hood CA-22, with headband, without ADF (w/o breathing system)	98,23
40 22 40	Welding hood CA-22, with headband and ADF V913 DS adc (w/o breathing system)	303,03
40 50 40	Autodarkening welding filter V913 DS adc, variable shade 9-13, view area 46,5x95mm	204,87
44 00 80	Air duct with velcro, face seal and 2 sweatbands for headband (assembly kit incl. assembling work, CA40x1/7" thread)	81,99



Safety Helmet CA - 40



70 40 00	Helmet CA - 40 with welding visor w/o ADF	247,20
70 40 60	CA - 40 face seal	38,63
70 40 40	Earmuffs for helmet, no. 8	29,77
70 40 41	Earmuffs for helmet, no. 10	37,18
70 40 42	Earmuffs for helmet, no. 12	42,80
70 40 43	Fixing screws 2 pcs.	3,81
70 40 41x	CA - 40 headband	25,96
70 40 80	CA - 40 protection plate outside (10 pcs.)	1,18
70 24 81	Protection plate inside, 107x51 polycarbonate (10 pcs.)	0,52
70 40 02	CA - 40 welding visor	33,48

40 50 40	Autodarkening welding filter V913 DS adc, variable shade 9-13, view area 46,5x95mm	204,87
-----------------	--	---------------

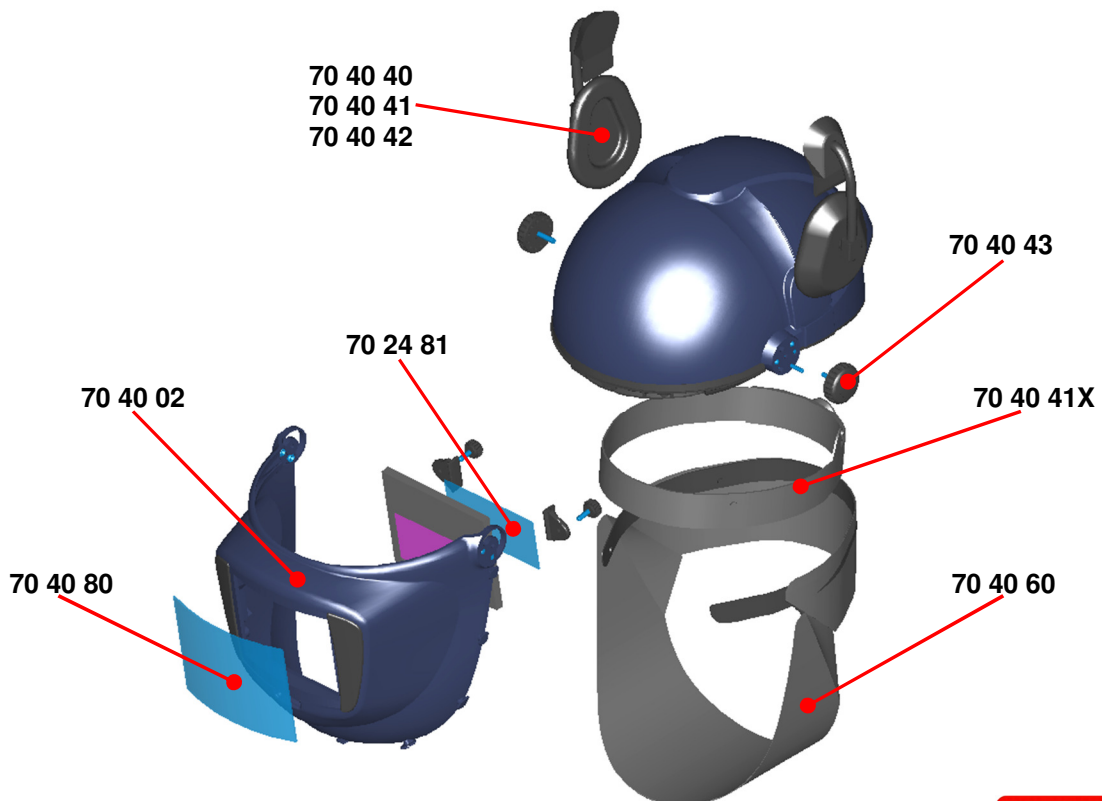











Leather welding hood CA-83 Ares





CA Pressure Ares and its accessories prices on request

CleanAIR Filters

	Particle filters		
	50 00 48	Filter P3	6.90
	80 00 10/2	Filter PSL for CA BASIC 2000 (pack of 2 pcs)	25.96
	Gas filters		
	50 01 56	Filter A2	10,92
	50 01 61	Filter B2	15,24
	50 01 59	Filter K2	15,55
	50 01 58	Filter A2B2	15,55
	50 01 63	Filter A2B2E2	15,76
	50 01 69	Filter A2B2E2K2	16,38

Combined filters			
	50 01 57	Filter A2P3	14,32
	50 01 62	Filter B2P3	17,61
	50 01 60	Filter K2P3	17,92
	50 01 67	Filter A2B2P3	17,92
	50 01 64	Filter A2B2E2P3	18,13
	50 01 68	Filter A2B2E2K2P3	18,75
	50 01 66	Filter A2B2E2K2HgP3	19,67
	50 01 73	Filter A2B2E2SXP3 - ozone	18,75
Filters with two RD40 threads			
	50 02 48	Filter P3 - with two RD40 threads	11,85
	50 02 57	Filter A2P3 - with two RD40 threads	19,26
	50 02 68	Filter A2B2E2K2P3 - with two RD40 threads	23,79
Light filters			
	50 03 57	Filter A1P3	13.40
	50 03 64	Filtr A1B1E1P3	17.10
Filter Accessories			
	50 01 09	Pre-filter keeper	2.00
	50 01 10	Pre-filter for canister filters-10 pcs prefilters + keeper	4.70
	50 01 10X	Pre-filter for canister filters-50 pcs prefilters + pre-filter keeper	23.40
	50 01 12	Spark arrester for canister filters - 2 pcs + 2 Pre-filter keepers (50 01 09)	7.00
	50 01 13	Spark arrester for canister filters - 3 pcs + 3 Pre-filter keepers (50 01 09)	9.50
	50 01 08	Canister filter cover	2.16
	58 00 13	Rubber filter cover	3.40

CleanAIR parts for old models

	40 00 10	Filter P3 for CA Basic	13,08
	40 00 15	Pre-filter CA Basic (pack of 10pcs)	7,10
	40 00 20	Odour-filter CA Basic (pack of 10pcs)	8,00
	40 00 30	Filter cover	3.19
	70 00 13M	Exchang.battery pack NiMH 3,6V/4,5Ah for CAB old version	133,69
	70 00 11M	Exchang.battery NiMH 4,8V/4,5Ah	168,71
	53 00 02	Keyboard for CA Chemical Flow Control	14,01
	53 00 04	Fan for CA Chemical with Flow Control electronics	206,82
	71 04 50	Air duct with old bayonet connector	37,90
	53 00 13	Exchangeable battery NiMH 7.2V/4,5Ah for CAC FC	207,40
	70 00 60BB	Light flexi hose bayonet – bayonet (to combine Basic 2000 or old Chemical unit with old headtops)	24,21
Welding hood CA - 21			
	70 21 00	Welding hood Kemppi CA-21 (window size 110x60)	130,19
	70 20 20	Protection plate polycarbonate (outside,inside) (pack of 10 pcs)	13,80
	70 21 41	Headband for welding hood CA-21,22 -with two sweatbands,w/o air duct	38,32
	70 21 53	Face seal for welding hoods -universal	14,73
Old Grinding visor CA - 3			
	70 03 20	Protective plate CA-3 (pack of 10pcs)	16,58
	70 03 30	Spare visor polycarbonate, with velcro	26,88
	70 03 33	Spare visor acetate, with velcro	35,02
	70 03 40	Headband with air duct and frontpart	47,07
	70 20 91	Headband	18,13
	70 03 61	Face seal (orange) with exhalation valve	18,03
	70 03 61G	Face seal (grey) with exhalation valve	18,03
	16 40 00	Head cover	17,20
	16 70 01	Sweatband	1,13

Welding filters		
70 20 25	Weldingfilter no.9 110 x 60 mm (pack of 10 pcs)	16,30
70 20 26	Weldingfilter no.10 110 x 60 mm (pack of 10 pcs)	16,30
70 20 27	Weldingfilter no.11 110 x 60 mm (pack of 10 pcs)	16,30
70 20 28	Weldingfilter no.12 110 x 60 mm (pack of 10 pcs)	16,30
70 20 29	Weldingfilter no.13 110 x 60 mm (pack of 10 pcs)	16,30
110/90-09	Weldingfilter no.9 110 x 90 mm (pack of 10 pcs)	16,30
110/90-10	Weldingfilter no.10 110 x 90 mm (pack of 10 pcs)	16,30
110/90-11	Weldingfilter no.11 110 x 90 mm (pack of 10 pcs)	16,30
110/90-12	Weldingfilter no.12 110 x 90 mm (pack of 10 pcs)	16,30
110/90-13	Weldingfilter no.13 110 x 90 mm (pack of 10 pcs)	16,30

16 40 00	Head cover	17,20
16 90 00	Protective neck cover	17,20



16 40 00
16 90 00



16 90 00



16 40 00



For safe breathing