

WIG-Brennerübersicht 1.0/V1



Copyright

Alle Texte, Bilder, Zeichnungen und sonstige in der Gesamtpreisliste veröffentlichten Informationen unterliegen – sofern nicht anders gekennzeichnet – dem Copyright der Alexander Binzel Schweisstechnik GmbH & Co. KG, Deutschland.

Jeglicher Nachdruck, auch auszugsweise, ist nur mit ausdrücklicher, schriftlicher Genehmigung der Alexander Binzel Schweisstechnik GmbH & Co. KG, Deutschland gestattet.



Inhalt

■ Über uns, Ansprechpartner ...

■ Hersteller	luftgekühlt (GC)	flüssiggekühlt (LC)
■ „artec“	●	●
■ „bester“	●	●
■ „castolin“	●	●
■ „cebora“	●	●
■ „cloos“	●	●
■ „d + l“	●	●
■ „dalex“	●	●
■ „elektra-beckum“	●	●
■ „esab“	●	●
■ „ess“	●	●
■ „esseti“	●	●
■ „ewm“	●	●
■ „fronius“	●	●
■ „hermann“	●	●
■ „jäckle“	●	●
■ „kempfi“	●	●
■ „kjellberg“	●	●
■ „lincoln“	●	●
■ „lorch“	●	●
■ „l-tec“	●	●
■ „mahe“	●	●
■ „merkle“	●	●
■ „messer-lincoln“	●	●
■ „migatroniC“	●	●
■ „migomat“	●	●
■ „nimak“	●	●
■ „oerlikon“	●	●
■ „pego“	●	●
■ „poro-bronze“	●	●
■ „rehm“	●	●
■ „röwac“	●	●
■ „röwac/röwig“	●	●
■ „rs-technologies“	●	●
■ „selco“	●	●
■ „stell“	●	●
■ „utp“	●	●
■ „weco“	●	●
■ „weltec“	●	●
■ „woltersdorf“	●	●
■ „MT-Brenner“	●	●
■ „V-Brenner“	●	●
■ Allgemeine Liefer- und Leistungsbedingungen		

Über uns ...



Spitzenposition im Weltmarkt.

Mit mehr als 850 Mitarbeitern, 30 Produktions- und Vertriebsgesellschaften sowie mit mehr als 20 Exklusivpartnern zählt die 1945 gegründete Alexander Binzel Schweißtechnik GmbH & Co. KG zu den Weltmarktführern in der Lichtbogen-Schweißtechnik und Brennertechnologie.

Neben einem qualitativ hochwertigen Produktprogramm bietet das Unternehmen komplexe individuelle Lösungen für die schweißtechnische Fertigung. Definierte Markenattribute und Garantien für die weltweiten Markterfolge sind: Entwicklungsstärke, Produktqualität, Engineering-Kompetenz und das internationale Vertriebs-, Beratungs- und Servicenetz.

In jedem Land stehen den Handelspartnern eigene Beratungs- und Betreuungsteams vor Ort zur Verfügung.



Qualität. Made by ABICOR BINZEL.

Unsere Produkte werden nach Binzel-Standards und internationalen Richtlinien gefertigt. Zertifiziert nach DIN EN ISO 9001.

Innovation. Heute und in Zukunft.

Wir entwickeln selbst in eigenen modernen Labors und in weltweiter Zusammenarbeit mit innovativen Köpfen aus Wissenschaft, Forschung und Industrie.



Global Player. Nähe zum Kunden – überall.

Weltweite Kundennähe ist eines der Erfolgsrezepte der Qualitätsmarke ABICOR BINZEL. Das in den letzten Jahren stark erweiterte Netz mit eigenen Gesellschaften und weiteren Länder-Vertretungen sichert der Marke die globale Beratungs-, Service- und Lieferkompetenz in den wichtigsten Industriestaaten sowie die weltweit lückenlose Versorgung der Kunden mit Originalteilen und Originalzubehör.

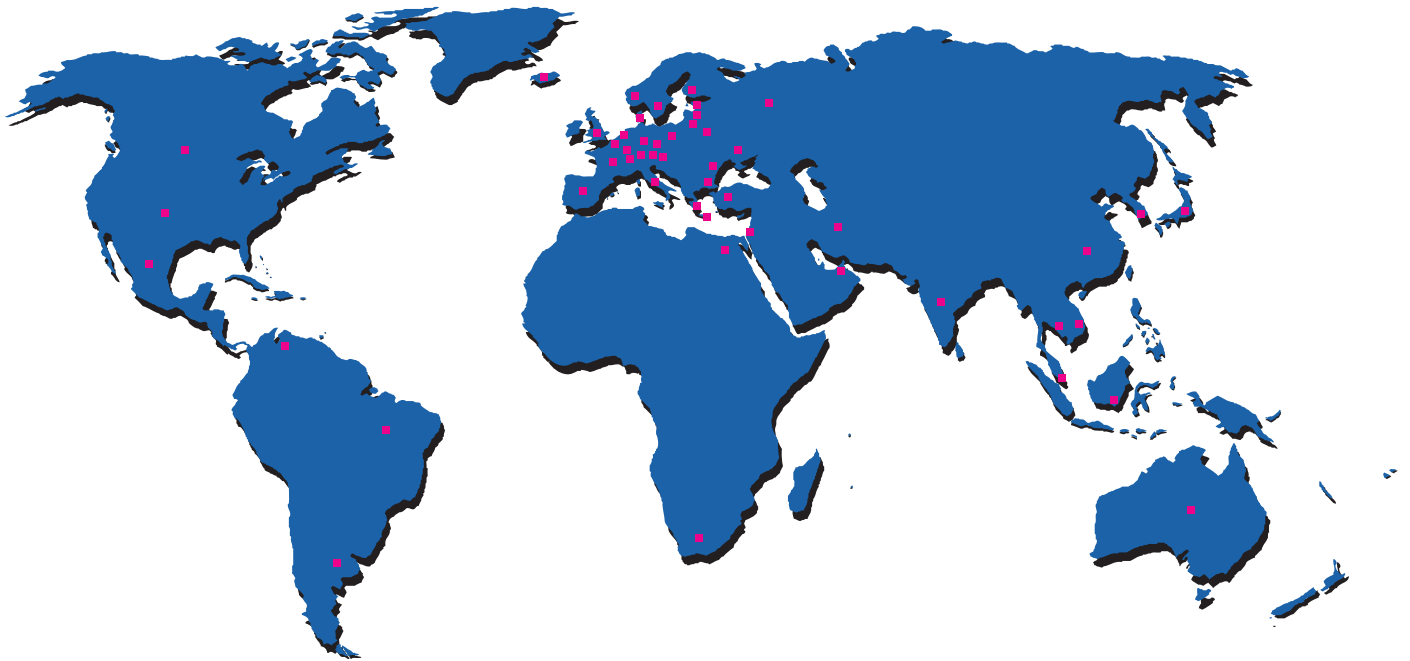

Original Markenqualität. International vertreten in:

 Ägypten	 Israel	 Spanien
 Argentinien	 Italien	 Südafrika
 Australien	 Japan	 Südkorea
 Belgien	 Kanada	 Thailand
 Brasilien	 Lettland	 Tschechische Republik
 Bulgarien	 Litauen	 Türkei
 China	 Luxemburg	 Ukraine
 Dänemark	 Mexiko	 Ungarn
 Deutschland	 Niederlande	 USA
 England	 Norwegen	 Venezuela
 Estland	 Österreich	 Ver. Arabische Emirate
 Finnland	 Polen	 Vietnam
 Frankreich	 Rumänien	 Weißrussland
 Griechenland	 Russland	 Zypern
 Indien	 Schweden	
 Indonesien	 Schweiz	
 Iran	 Singapur	
 Island	 Slowakische Republik	

Ihre Ansprechpartner im Außendienst ...



Wolfgang Wenzel

Tel.: 03 81/69 05 31
Handy: 01 71/76 62 026
E-Mail: wenzel@binzel-abicor.com



Andreas Paul

Tel.: 0 53 41/22 39 293
Handy: 01 71/76 62 024
E-Mail: paul@binzel-abicor.com



Heiner Makoschey

Tel.: 02 21/86 98 937
Handy: 01 71/76 62 023
E-Mail: makoschey@binzel-abicor.com



Uwe Lein

Tel.: 03 71/80 00 821
Handy: 01 71/76 62 025
E-Mail: lein@binzel-abicor.com



Uwe Meierhöfer

Tel.: 05 31/23 92 830
Handy: 01 71/76 62 027
E-Mail: meierhoefer@binzel-abicor.com



Klaus Göb

Tel.: 0 97 21/50 98 974
Handy: 01 71/76 62 028
E-Mail: goeb@binzel-abicor.com



Matthias Zughorst

Tel.: 0 71 41/4813 55
Handy: 01 71/76 62 022
E-Mail: zughorst@binzel-abicor.com

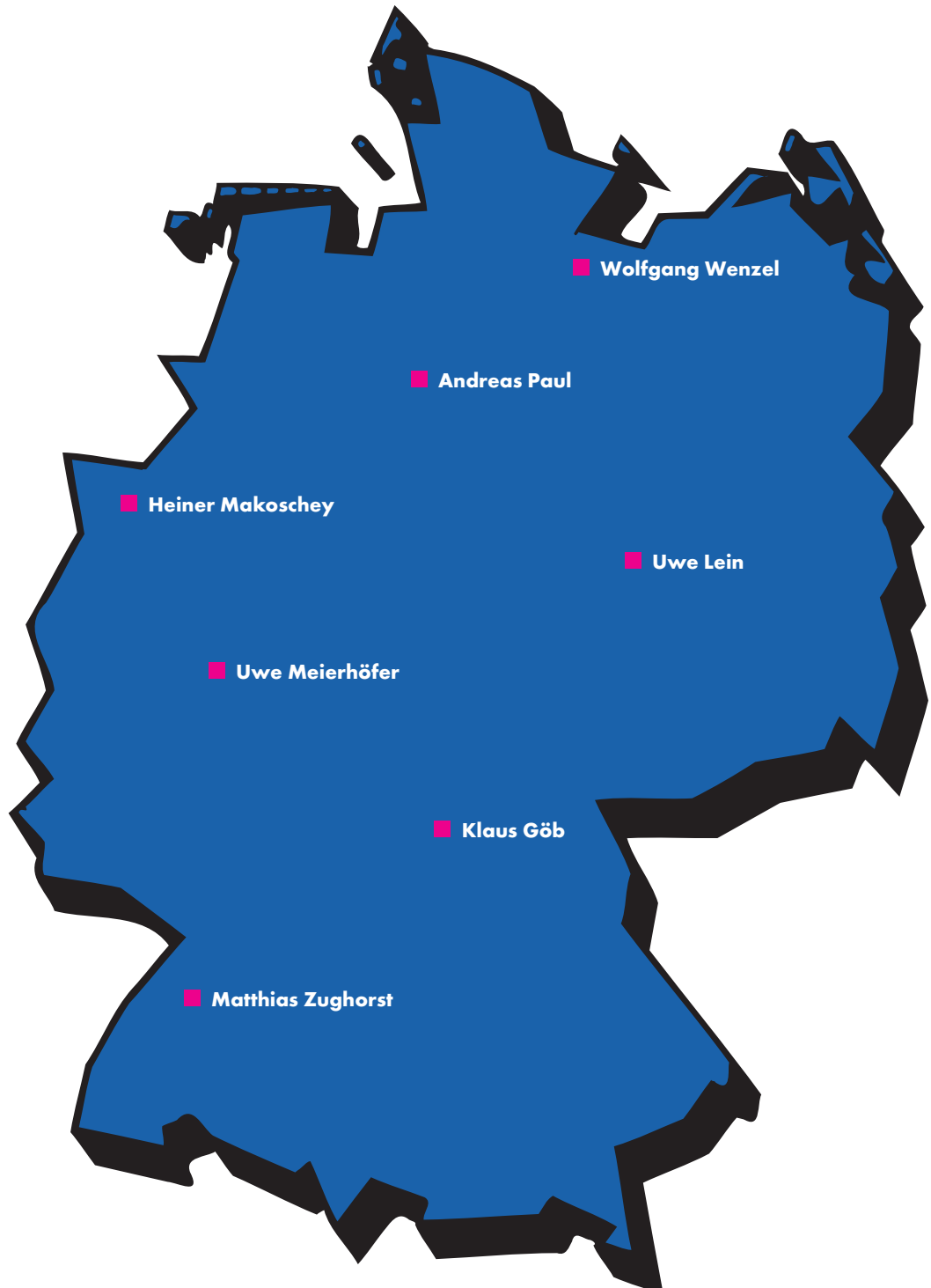

Ihre Ansprechpartner im Innendienst ...



Jörg Lehnhäuser

Direktor Vertrieb Deutschland
Tel.: 0 64 08/59-280
E-Mail: lehnhaeuser.j@binzel-abicor.com



Diana Hofmann

Sekretariat Vertrieb Deutschland
Tel.: 0 64 08/59-116
E-Mail: hofmann.d@binzel-abicor.com



Thomas Sohn

Gruppenleiter Vertrieb Deutschland
Tel.: 0 64 08/59-107
E-Mail: sohn.t@binzel-abicor.com



Stephan Bartel

Kundenberater Vertrieb Deutschland
Tel.: 0 64 08/59-110
E-Mail: bartel@binzel-abicor.com



Carsten Crombach

Kundenberater Vertrieb Deutschland
Tel.: 0 64 08/59-167
E-Mail: crombach@binzel-abicor.com



Birgit Dittrich

Kundenberaterin Vertrieb Deutschland
Tel.: 0 64 08/59-112
E-Mail: dittrich@binzel-abicor.com



Andreas Faber

Kundenberater Vertrieb Deutschland
Tel.: 0 64 08/59-121
E-Mail: faber.a@binzel-abicor.com



Bianka Koch

Kundenberaterin Vertrieb Deutschland
Tel.: 0 64 08/59-109
E-Mail: koch@binzel-abicor.com



Markus Preis

Kundenberater Vertrieb Deutschland
Tel.: 0 64 08/59-123
E-Mail: preis@binzel-abicor.com

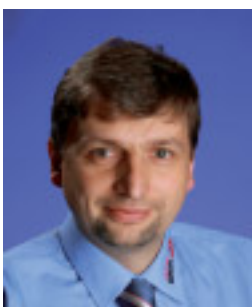

Jörg Reips

Customer Service Vertrieb Deutschland
Tel.: 0 64 08/59-255
E-Mail: reips@binzel-abicor.com



Andrea Sann

Kundenberaterin Vertrieb Deutschland
Tel.: 0 64 08/59-123
E-Mail: sann@binzel-abicor.com



Erläuterung zur ABITIG® WIG-Brennerpreisliste

Abkürzungen zu den Abbildungen:

iso.	isoliert
G	Gas
→	Kühlmittelrücklauf rot
←	Kühlmittelvorlauf blau

Abkürzungen für maschinenseitige Anschlüsse:

EA	Einzelanschluß
BSB 10-25	Schweißkabelstecker 10-25 (Ø 9 mm)
BSB 35-50	Schweißkabelstecker 35-50 (Ø 13 mm)
ZA-GZ	WIG-Zentralanschluß für luftgekühlte Brenner
ZA-WZ-0	WIG-Zentralanschluß für flüssiggekühlte Brenner
ZA-WTG-5	WIG-Zentralanschluß für luftgekühlte Brenner mit integrierter Steuerleitung
ZA-WTW-5	WIG-Zentralanschluß für flüssiggekühlte Brenner mit integrierter Steuerleitung
ZA 9-pol.	Zentralanschluß MechaFin (z. B. für „esab“, „kemppi“, „migatron“)“)
cloos	Anschluß für „cloos“-Schweißanlagen
BSB/CG	Kombistecker (Strom- und Gasführung geht über den Stecker)
dalex - BSB/CF	„dalex“ Kombistecker (Kühlflüssigkeitsführung durch den Stecker)
oerlikon - ZA	Stecker für „oerlikon“-Anlagen
MAG ZA	Für Kombi-Geräte (Cloos/Lorch/Merkle/Stell)
TCG	Kombistecker-Merkle

Anmerkungen zu den Schlauchpaketen:

Standard:	Kugelgelenk am Griff, Überzugschlauch Gummi durchgehend, Stromkabel mit PVC-Schlauch.
High Flex:	Kugelgelenk am Griff, 80 cm Lederschlauch, BiClip-Verbindung zum Gummiüberzugschlauch, Alle Schläuche hochflexibel mit Gummigewebeschlauch.
Schlauchpaketlängen:	Alle Varianten-Komplettbrenner sind auch in 12 und 16 Meter lieferbar.

Wichtiger Hinweis:

Die Angaben zu der Steckerbelegung sind nach dem Kenntnisstand von ABICOR BINZEL identisch mit der Originalbelegung des entsprechenden Geräteherstellers. Für die Angaben können wir jedoch keine Garantie übernehmen.

Die Schlauchpakete werden mit der dargestellten Belegung ausgeliefert, es sei denn, bei Ihrer Bestellung wird eine andere Belegung vorgegeben.

Sollte sich unsererseits ein Fehler eingeschlichen haben, bitten wir um Ihre Rückmeldung.

Anmerkungen zu den Brennerkörperausführungen:

- Die Brenner ABITIG® 18 , 26, 200 und 450 W sind auch in der Brennerkörperausführung "kurz" lieferbar.
- Die Brenner ABITIG® 20 F sind auch in den Brennerkörperlängen 30 und 65 mm verlängert lieferbar.

Abkürzungen für Schalterfunktion:

ED	Einfachdrucktaster
DD	Doppeldrucktaster
UD	Up/Down (zwei Wippen)
EDP*	Einfachdrucktaster mit Potentiometer 10 kΩ, andere Werte auf Anfrage (z.B. 1,0 kΩ, 2,2 kΩ, 4,7 kΩ, 47 kΩ)
DDP*	Doppeldrucktaster mit Potentiometer 10 kΩ, andere Werte auf Anfrage (z.B. 1,0 kΩ, 2,2 kΩ, 4,7 kΩ, 47 kΩ)

* Bei Potentiometerregelung im Handgriff ist ein HF-Filter dann zwingend notwendig, wenn die Poti-Leitung über die Fernreglerbuchse geführt und mit Hochspannungsimpulsen gezündet wird. Bei fehlendem HF-Filter kann es – durch die HF Impulse – zu Schäden an der Steuerelektronik kommen.
Bitte bestellen Sie den HF-Steuerleitungsfilter DGF 3 mit folgender Bestell-Nr.: 184.0162

Erläuterung zur ABITIG® WIG-Brennerpreisliste

Alternativen zu den Standard-Ansteuermodulen (BIS):

Bedingt durch die grosse Anzahl von Ausführungsvarianten wäre es zu umfangreich, alle Brenner mit allen Ansteuermodulen aufzuführen. Daher hat ABICOR BINZEL in dieser Brennerpreisliste Standard-Module definiert (z. B. BIS-02 bei Doppeldruck). Alternativen dazu finden Sie unten aufgeführt.

Bei den vom Standard abweichenden Bestellungen tauschen Sie bitte das Standard-Ansteuermodul an den markierten Positionen durch das von Ihnen gewünschte Ansteuermodul aus.

Bestell-Nummer:

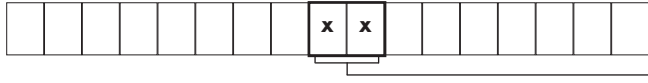

Ansteuermodul BIS

Hier bitte das alternativ gewünschte Ansteuermodul einsetzen,
z. B. statt 02 = 10
04 = 22 usw.

Handgriff ABITIG®

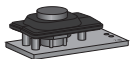

BIS-01
ED = Einfachdruck

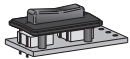

BIS-02
DD = Doppeldruck
Taster kurz
(In der Brennerpreisliste
Standard bei DD)

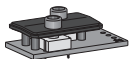

BIS-12
DD = Doppeldruck
zwei Taster
(Alternative zu BIS-02)

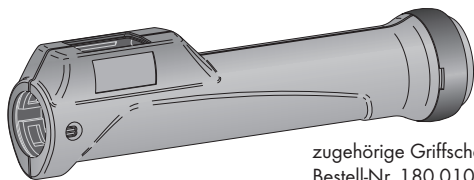

zugehörige Griffschale
Bestell-Nr. 180.0108

Handgriff ABITIG® SH

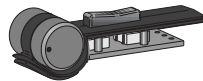

BIS-04 - 10 K-Ohm

DD/Poti = Doppeldruck Poti

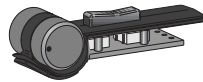

BIS-09
EDP = Einfachdruck/Poti
10 K-Ohm
(Kompatibel zu Migatronik)

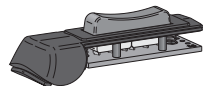

BIS-10
DD = Doppeldruck/Taster lang
für höhere Einschaltströme bis 2 A
(z. B. Dalex, Messer-Lincoln)

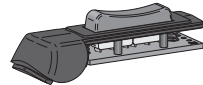

BIS-11
DD = Doppeldruck/Taster lang
(Alternative zu BIS-02)

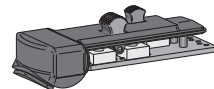

BIS-15
UD = Up/Down
(Geräteabhängig)

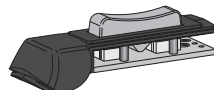

BIS-17
DD = Doppeldruck/Wippe

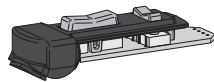

BIS-45
UD = Up/Down
(Kompatibel zu Lorch)

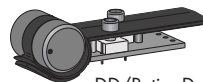

BIS-22 - 10 K-Ohm

DD/Poti = Doppeldruck
Poti zwei Taster
(Alternative zu BIS-04 bis -44)

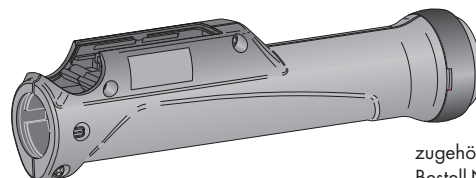

zugehörige Griffschale
Bestell-Nr. 180.0109

ABITIG®-Brennerpreisliste

passend für WIG-Stromquellen des Fabrikates „artec“



Brennertyp	Länge	Schalterfunktion	maschinenseitiger Anschluss	Schlauchpaketausführung	Bestellnummer
ABITIG® 9	4 m	ED	BSB 35-50 Tuchel 5-pol.	Standard	7S1SK043010006A06
	8 m	ED	BSB 35-50 Tuchel 5-pol.	Standard	7S1SK083010006A06
	4 m	ED	BSB 35-50 Tuchel 5-pol.	High Flex Leder	7S1SH043010006A06
	8 m	ED	BSB 35-50 Tuchel 5-pol.	High Flex Leder	7S1SH083010006A06
ABITIG® 9F	4 m	ED	BSB 35-50 Tuchel 5-pol.	Standard	7S1FK043010006A06
	8 m	ED	BSB 35-50 Tuchel 5-pol.	Standard	7S1FK083010006A06
	4 m	ED	BSB 35-50 Tuchel 5-pol.	High Flex Leder	7S1FH043010006A06
	8 m	ED	BSB 35-50 Tuchel 5-pol.	High Flex Leder	7S1FH083010006A06
ABITIG® 17	4 m	ED	BSB 35-50 Tuchel 5-pol.	Standard	7S2SK043010006A06
	8 m	ED	BSB 35-50 Tuchel 5-pol.	Standard	7S2SK083010006A06
	4 m	ED	BSB 35-50 Tuchel 5-pol.	High Flex Leder	7S2SH043010006A06
	8 m	ED	BSB 35-50 Tuchel 5-pol.	High Flex Leder	7S2SH083010006A06
ABITIG® 17F	4 m	ED	BSB 35-50 Tuchel 5-pol.	Standard	7S2FK043010006A06
	8 m	ED	BSB 35-50 Tuchel 5-pol.	Standard	7S2FK083010006A06
	4 m	ED	BSB 35-50 Tuchel 5-pol.	High Flex Leder	7S2FH043010006A06
	8 m	ED	BSB 35-50 Tuchel 5-pol.	High Flex Leder	7S2FH083010006A06

Technische Änderungen vorbehalten • Verkaufspreise = unverbindliche Preisempfehlung - Angebot freibleibend • © Copyright

ABITIG®-Brennerpreisliste

passend für WIG-Stromquellen des Fabrikates „artec“

Brennertyp	Länge	Schalterfunktion	maschinenseitiger Anschluss	Schlauchpaketausführung	Bestellnummer
ABITIG® 26	4 m	ED	BSB 35-50 Tuchel 5-pol.	Standard	7S3SK043010006A06
	8 m	ED	BSB 35-50 Tuchel 5-pol.	Standard	7S3SK083010006A06
	4 m	ED	BSB 35-50 Tuchel 5-pol.	High Flex Leder	7S3SH043010006A06
	8 m	ED	BSB 35-50 Tuchel 5-pol.	High Flex Leder	7S3SH083010006A06
ABITIG® 26F	4 m	ED	BSB 35-50 Tuchel 5-pol.	Standard	7S3FK043010006A06
	8 m	ED	BSB 35-50 Tuchel 5-pol.	Standard	7S3FK083010006A06
	4 m	ED	BSB 35-50 Tuchel 5-pol.	High Flex Leder	7S3FH043010006A06
	8 m	ED	BSB 35-50 Tuchel 5-pol.	High Flex Leder	7S3FH083010006A06
ABITIG® 24G	4 m	ED	BSB 35-50 Tuchel 5-pol.	Standard	7S8SK043010006A06
	8 m	ED	BSB 35-50 Tuchel 5-pol.	Standard	7S8SK083010006A06
	4 m	ED	BSB 35-50 Tuchel 5-pol.	High Flex Leder	7S8SH043010006A06
	8 m	ED	BSB 35-50 Tuchel 5-pol.	High Flex Leder	7S8SH083010006A06
ABITIG® 200	4 m	ED	BSB 35-50 Tuchel 5-pol.	Standard	7T4SK043010006A06
	8 m	ED	BSB 35-50 Tuchel 5-pol.	Standard	7T4SK083010006A06
	4 m	ED	BSB 35-50 Tuchel 5-pol.	High Flex Leder	7T4SH043010006A06
	8 m	ED	BSB 35-50 Tuchel 5-pol.	High Flex Leder	7T4SH083010006A06
ABITIG® 200F	4 m	ED	BSB 35-50 Tuchel 5-pol.	Standard	7T4FK043010006A06
	8 m	ED	BSB 35-50 Tuchel 5-pol.	Standard	7T4FK083010006A06
	4 m	ED	BSB 35-50 Tuchel 5-pol.	High Flex Leder	7T4FH043010006A06
	8 m	ED	BSB 35-50 Tuchel 5-pol.	High Flex Leder	7T4FH083010006A06
ABITIG® 150	4 m	ED	BSB 35-50 Tuchel 5-pol.	Standard	7T6SK043010006A06
	8 m	ED	BSB 35-50 Tuchel 5-pol.	Standard	7T6SK083010006A06
	4 m	ED	BSB 35-50 Tuchel 5-pol.	High Flex Leder	7T6SH043010006A06
	8 m	ED	BSB 35-50 Tuchel 5-pol.	High Flex Leder	7T6SH083010006A06
ABITIG® 150F	4 m	ED	BSB 35-50 Tuchel 5-pol.	Standard	7T6FK043010006A06
	8 m	ED	BSB 35-50 Tuchel 5-pol.	Standard	7T6FK083010006A06
	4 m	ED	BSB 35-50 Tuchel 5-pol.	High Flex Leder	7T6FH043010006A06
	8 m	ED	BSB 35-50 Tuchel 5-pol.	High Flex Leder	7T6FH083010006A06

ABITIG®-Brennerpreisliste

passend für WIG-Stromquellen des Fabrikates „artec“



Brennertyp	Länge	Schalterfunktion	maschinenseitiger Anschluss	Schlauchpaketausführung	Bestellnummer
ABITIG® 9	4 m	DD	BSB 35-50 Tuchel 5-pol.	Standard	7S1SK043020001B06
	8 m	DD	BSB 35-50 Tuchel 5-pol.	Standard	7S1SK083020001B06
	4 m	DD	BSB 35-50 Tuchel 5-pol.	High Flex Leder	7S1SH043020001B06
	8 m	DD	BSB 35-50 Tuchel 5-pol.	High Flex Leder	7S1SH083020001B06
ABITIG® 9F	4 m	DD	BSB 35-50 Tuchel 5-pol.	Standard	7S1FK043020001B06
	8 m	DD	BSB 35-50 Tuchel 5-pol.	Standard	7S1FK083020001B06
	4 m	DD	BSB 35-50 Tuchel 5-pol.	High Flex Leder	7S1FH043020001B06
	8 m	DD	BSB 35-50 Tuchel 5-pol.	High Flex Leder	7S1FH083020001B06
ABITIG® 17	4 m	DD	BSB 35-50 Tuchel 5-pol.	Standard	7S2SK043020001B06
	8 m	DD	BSB 35-50 Tuchel 5-pol.	Standard	7S2SK083020001B06
	4 m	DD	BSB 35-50 Tuchel 5-pol.	High Flex Leder	7S2SH043020001B06
	8 m	DD	BSB 35-50 Tuchel 5-pol.	High Flex Leder	7S2SH083020001B06
ABITIG® 17F	4 m	DD	BSB 35-50 Tuchel 5-pol.	Standard	7S2FK043020001B06
	8 m	DD	BSB 35-50 Tuchel 5-pol.	Standard	7S2FK083020001B06
	4 m	DD	BSB 35-50 Tuchel 5-pol.	High Flex Leder	7S2FH043020001B06
	8 m	DD	BSB 35-50 Tuchel 5-pol.	High Flex Leder	7S2FH083020001B06

Technische Änderungen vorbehalten • Verkaufspreise = unverbindliche Preisempfehlung - Angebot freibleibend • © Copyright

ABITIG®-Brennerpreisliste

passend für WIG-Stromquellen des Fabrikates „artec“

Brennertyp	Länge	Schalterfunktion	maschinenseitiger Anschluss	Schlauchpaketausführung	Bestellnummer
ABITIG® 26	4 m	DD	BSB 35-50 Tuchel 5-pol.	Standard	7S3SK043020001B06
	8 m	DD	BSB 35-50 Tuchel 5-pol.	Standard	7S3SK083020001B06
	4 m	DD	BSB 35-50 Tuchel 5-pol.	High Flex Leder	7S3SH043020001B06
	8 m	DD	BSB 35-50 Tuchel 5-pol.	High Flex Leder	7S3SH083020001B06

ABITIG® 26F	4 m	DD	BSB 35-50 Tuchel 5-pol.	Standard	7S3FK043020001B06
	8 m	DD	BSB 35-50 Tuchel 5-pol.	Standard	7S3FK083020001B06
	4 m	DD	BSB 35-50 Tuchel 5-pol.	High Flex Leder	7S3FH043020001B06
	8 m	DD	BSB 35-50 Tuchel 5-pol.	High Flex Leder	7S3FH083020001B06

ABITIG® 24G	4 m	DD	BSB 35-50 Tuchel 5-pol.	Standard	7S8SK043020001B06
	8 m	DD	BSB 35-50 Tuchel 5-pol.	Standard	7S8SK083020001B06
	4 m	DD	BSB 35-50 Tuchel 5-pol.	High Flex Leder	7S8SH043020001B06
	8 m	DD	BSB 35-50 Tuchel 5-pol.	High Flex Leder	7S8SH083020001B06

ABITIG® 200	4 m	DD	BSB 35-50 Tuchel 5-pol.	Standard	7T4SK043020001B06
	8 m	DD	BSB 35-50 Tuchel 5-pol.	Standard	7T4SK083020001B06
	4 m	DD	BSB 35-50 Tuchel 5-pol.	High Flex Leder	7T4SH043020001B06
	8 m	DD	BSB 35-50 Tuchel 5-pol.	High Flex Leder	7T4SH083020001B06

ABITIG® 200F	4 m	DD	BSB 35-50 Tuchel 5-pol.	Standard	7T4FK043020001B06
	8 m	DD	BSB 35-50 Tuchel 5-pol.	Standard	7T4FK083020001B06
	4 m	DD	BSB 35-50 Tuchel 5-pol.	High Flex Leder	7T4FH043020001B06
	8 m	DD	BSB 35-50 Tuchel 5-pol.	High Flex Leder	7T4FH083020001B06

ABITIG® 150	4 m	DD	BSB 35-50 Tuchel 5-pol.	Standard	7T6SK043020001B06
	8 m	DD	BSB 35-50 Tuchel 5-pol.	Standard	7T6SK083020001B06
	4 m	DD	BSB 35-50 Tuchel 5-pol.	High Flex Leder	7T6SH043020001B06
	8 m	DD	BSB 35-50 Tuchel 5-pol.	High Flex Leder	7T6SH083020001B06

ABITIG® 150F	4 m	DD	BSB 35-50 Tuchel 5-pol.	Standard	7T6FK043020001B06
	8 m	DD	BSB 35-50 Tuchel 5-pol.	Standard	7T6FK083020001B06
	4 m	DD	BSB 35-50 Tuchel 5-pol.	High Flex Leder	7T6FH043020001B06
	8 m	DD	BSB 35-50 Tuchel 5-pol.	High Flex Leder	7T6FH083020001B06

ABITIG®-Brennerpreisliste

passend für WIG-Stromquellen des Fabrikates „artec“



Brennertyp	Länge	Schalterfunktion	maschinenseitiger Anschluss	Schlauchpaketausführung	Bestellnummer
ABITIG® 18	4 m	ED	BSB 35-50 Tuchel 5-pol.	Standard	7S4SK043010002A20
	8 m	ED	BSB 35-50 Tuchel 5-pol.	Standard	7S4SK083010002A20
	4 m	ED	BSB 35-50 Tuchel 5-pol.	High Flex Leder	7S4SH043010002A20
	8 m	ED	BSB 35-50 Tuchel 5-pol.	High Flex Leder	7S4SH083010002A20
ABITIG® 18F	4 m	ED	BSB 35-50 Tuchel 5-pol.	Standard	7S4FK043010002A20
	8 m	ED	BSB 35-50 Tuchel 5-pol.	Standard	7S4FK083010002A20
	4 m	ED	BSB 35-50 Tuchel 5-pol.	High Flex Leder	7S4FH043010002A20
	8 m	ED	BSB 35-50 Tuchel 5-pol.	High Flex Leder	7S4FH083010002A20
ABITIG® 20	4 m	ED	BSB 35-50 Tuchel 5-pol.	Standard	7S5SK043010002A20
	8 m	ED	BSB 35-50 Tuchel 5-pol.	Standard	7S5SK083010002A20
	4 m	ED	BSB 35-50 Tuchel 5-pol.	High Flex Leder	7S5SH043010002A20
	8 m	ED	BSB 35-50 Tuchel 5-pol.	High Flex Leder	7S5SH083010002A20
ABITIG® 20F	4 m	ED	BSB 35-50 Tuchel 5-pol.	Standard	7S5FK043010002A20
	8 m	ED	BSB 35-50 Tuchel 5-pol.	Standard	7S5FK083010002A20
	4 m	ED	BSB 35-50 Tuchel 5-pol.	High Flex Leder	7S5FH043010002A20
	8 m	ED	BSB 35-50 Tuchel 5-pol.	High Flex Leder	7S5FH083010002A20

Technische Änderungen vorbehalten • Verkaufspreise = unverbindliche Preisempfehlung - Angebot freibleibend • © Copyright

ABITIG®-Brennerpreisliste

passend für WIG-Stromquellen des Fabrikates „artec“

Brennertyp	Länge	Schalterfunktion	maschinenseitiger Anschluss	Schlauchpaketausführung	Bestellnummer
ABITIG® 12-1	4 m	ED	BSB 35-50 Tuchel 5-pol.	Standard	7S6SK043010002A20
	8 m	ED	BSB 35-50 Tuchel 5-pol.	Standard	7S6SK083010002A20
	4 m	ED	BSB 35-50 Tuchel 5-pol.	High Flex Leder	7S6SH043010002A20
	8 m	ED	BSB 35-50 Tuchel 5-pol.	High Flex Leder	7S6SH083010002A20

ABITIG® 18SC	4 m	ED	BSB 35-50 Tuchel 5-pol.	Standard	7S7SK043010002A20
	8 m	ED	BSB 35-50 Tuchel 5-pol.	Standard	7S7SK083010002A20
	4 m	ED	BSB 35-50 Tuchel 5-pol.	High Flex Leder	7S7SH043010002A20
	8 m	ED	BSB 35-50 Tuchel 5-pol.	High Flex Leder	7S7SH083010002A20

ABITIG® 24W	4 m	ED	BSB 35-50 Tuchel 5-pol.	Standard	7S9SK043010002A20
	8 m	ED	BSB 35-50 Tuchel 5-pol.	Standard	7S9SK083010002A20
	4 m	ED	BSB 35-50 Tuchel 5-pol.	High Flex Leder	7S9SH043010002A20
	8 m	ED	BSB 35-50 Tuchel 5-pol.	High Flex Leder	7S9SH083010002A20

ABITIG® 450W	4 m	ED	BSB 35-50 Tuchel 5-pol.	Standard	7T5SK043010102A20
	8 m	ED	BSB 35-50 Tuchel 5-pol.	Standard	7T5SK083010102A20
	4 m	ED	BSB 35-50 Tuchel 5-pol.	High Flex Leder	7T5SH043010102A20
	8 m	ED	BSB 35-50 Tuchel 5-pol.	High Flex Leder	7T5SH083010102A20

ABITIG® 260W	4 m	ED	BSB 35-50 Tuchel 5-pol.	Standard	7T7SK043010102A20
	8 m	ED	BSB 35-50 Tuchel 5-pol.	Standard	7T7SK083010102A20
	4 m	ED	BSB 35-50 Tuchel 5-pol.	High Flex Leder	7T7SH043010102A20
	8 m	ED	BSB 35-50 Tuchel 5-pol.	High Flex Leder	7T7SH083010102A20

ABITIG® 450W SC	4 m	ED	BSB 35-50 Tuchel 5-pol.	Standard	
	8 m	ED	BSB 35-50 Tuchel 5-pol.	Standard	
	4 m	ED	BSB 35-50 Tuchel 5-pol.	High Flex Leder	7T8SH043010102A20
	8 m	ED	BSB 35-50 Tuchel 5-pol.	High Flex Leder	7T8SH083010102A20

ABITIG®-Brennerpreisliste

passend für WIG-Stromquellen des Fabrikates „artec“



Brennertyp	Länge	Schalterfunktion	maschinenseitiger Anschluss	Schlauchpaketausführung	Bestellnummer
ABITIG® 18	4 m	DD	BSB 35-50 Tuchel 5-pol.	Standard	7S4SK043020001B20
	8 m	DD	BSB 35-50 Tuchel 5-pol.	Standard	7S4SK083020001B20
	4 m	DD	BSB 35-50 Tuchel 5-pol.	High Flex Leder	7S4SH043020001B20
	8 m	DD	BSB 35-50 Tuchel 5-pol.	High Flex Leder	7S4SH083020001B20
ABITIG® 18F	4 m	DD	BSB 35-50 Tuchel 5-pol.	Standard	7S4FK043020001B20
	8 m	DD	BSB 35-50 Tuchel 5-pol.	Standard	7S4FK083020001B20
	4 m	DD	BSB 35-50 Tuchel 5-pol.	High Flex Leder	7S4FH043020001B20
	8 m	DD	BSB 35-50 Tuchel 5-pol.	High Flex Leder	7S4FH083020001B20
ABITIG® 20	4 m	DD	BSB 35-50 Tuchel 5-pol.	Standard	7S5SK043020001B20
	8 m	DD	BSB 35-50 Tuchel 5-pol.	Standard	7S5SK083020001B20
	4 m	DD	BSB 35-50 Tuchel 5-pol.	High Flex Leder	7S5SH043020001B20
	8 m	DD	BSB 35-50 Tuchel 5-pol.	High Flex Leder	7S5SH083020001B20
ABITIG® 20F	4 m	DD	BSB 35-50 Tuchel 5-pol.	Standard	7S5FK043020001B20
	8 m	DD	BSB 35-50 Tuchel 5-pol.	Standard	7S5FK083020001B20
	4 m	DD	BSB 35-50 Tuchel 5-pol.	High Flex Leder	7S5FH043020001B20
	8 m	DD	BSB 35-50 Tuchel 5-pol.	High Flex Leder	7S5FH083020001B20

Technische Änderungen vorbehalten • Verkaufspreise = unverbindliche Preisempfehlung - Angebot freibleibend • © Copyright

ABITIG®-Brennerpreisliste

passend für WIG-Stromquellen des Fabrikates „artec“

Brennertyp	Länge	Schalterfunktion	maschinenseitiger Anschluss	Schlauchpaketausführung	Bestellnummer
ABITIG® 12-1	4 m	DD	BSB 35-50 Tuchel 5-pol.	Standard	7S6SK043020001B20
	8 m	DD	BSB 35-50 Tuchel 5-pol.	Standard	7S6SK083020001B20
	4 m	DD	BSB 35-50 Tuchel 5-pol.	High Flex Leder	7S6SH043020001B20
	8 m	DD	BSB 35-50 Tuchel 5-pol.	High Flex Leder	7S6SH083020001B20
ABITIG® 18SC	4 m	DD	BSB 35-50 Tuchel 5-pol.	Standard	7S7SK043020001B20
	8 m	DD	BSB 35-50 Tuchel 5-pol.	Standard	7S7SK083020001B20
	4 m	DD	BSB 35-50 Tuchel 5-pol.	High Flex Leder	7S7SH043020001B20
	8 m	DD	BSB 35-50 Tuchel 5-pol.	High Flex Leder	7S7SH083020001B20
ABITIG® 24W	4 m	DD	BSB 35-50 Tuchel 5-pol.	Standard	7S9SK043020001B20
	8 m	DD	BSB 35-50 Tuchel 5-pol.	Standard	7S9SK083020001B20
	4 m	DD	BSB 35-50 Tuchel 5-pol.	High Flex Leder	7S9SH043020001B20
	8 m	DD	BSB 35-50 Tuchel 5-pol.	High Flex Leder	7S9SH083020001B20
ABITIG® 450W	4 m	DD	BSB 35-50 Tuchel 5-pol.	Standard	7T5SK043020101B20
	8 m	DD	BSB 35-50 Tuchel 5-pol.	Standard	7T5SK083020101B20
	4 m	DD	BSB 35-50 Tuchel 5-pol.	High Flex Leder	7T5SH043020101B20
	8 m	DD	BSB 35-50 Tuchel 5-pol.	High Flex Leder	7T5SH083020101B20
ABITIG® 260W	4 m	DD	BSB 35-50 Tuchel 5-pol.	Standard	7T7SK043020101B20
	8 m	DD	BSB 35-50 Tuchel 5-pol.	Standard	7T7SK083020101B20
	4 m	DD	BSB 35-50 Tuchel 5-pol.	High Flex Leder	7T7SH043020101B20
	8 m	DD	BSB 35-50 Tuchel 5-pol.	High Flex Leder	7T7SH083020101B20
ABITIG® 450W SC	4 m	DD	BSB 35-50 Tuchel 5-pol.	Standard	
	8 m	DD	BSB 35-50 Tuchel 5-pol.	Standard	
	4 m	DD	BSB 35-50 Tuchel 5-pol.	High Flex Leder	7T8SH043020101B20
	8 m	DD	BSB 35-50 Tuchel 5-pol.	High Flex Leder	7T8SH083020101B20

ABITIG®-Brennerpreisliste

passend für WIG-Stromquellen des Fabrikates „bester“

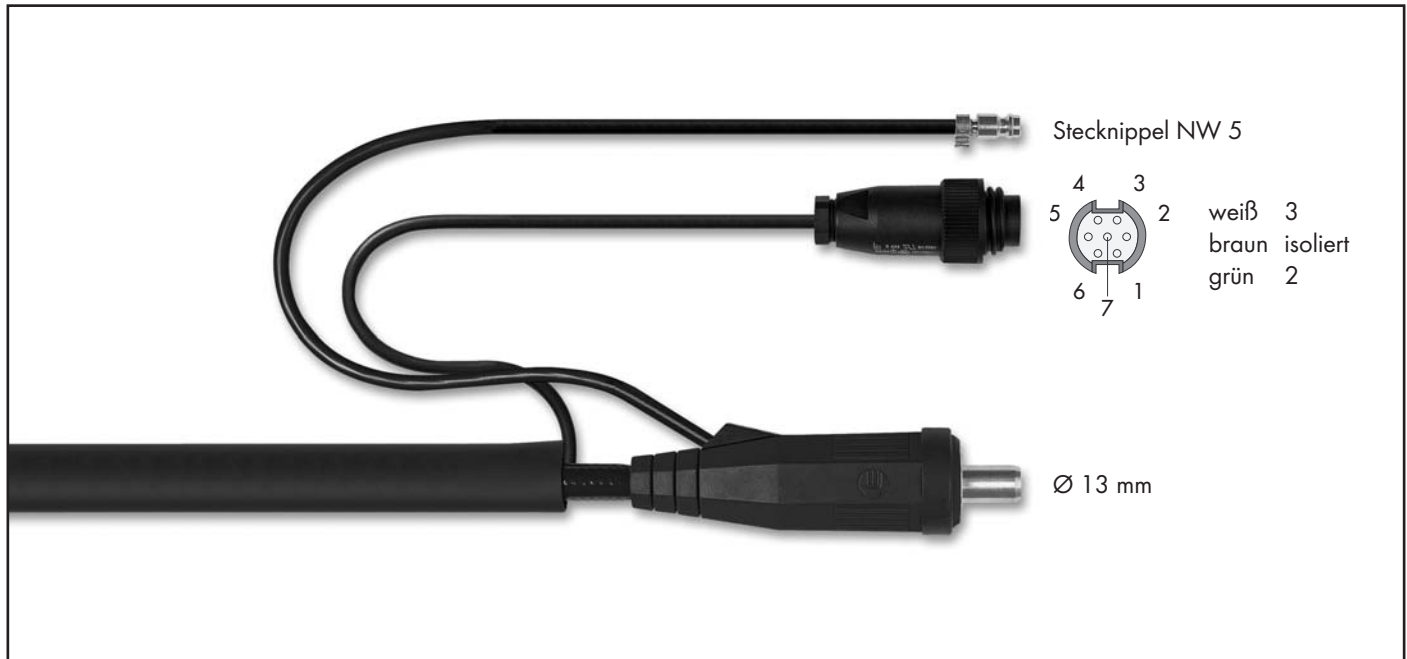

Brennertyp	Länge	Schalterfunktion	maschinenseitiger Anschluss	Schlauchpaketausführung	Bestellnummer
ABITIG® 9	4 m	ED	BSB 35-50 Rundsteckverbinder 7-pol.	Standard	7S1SK043010012B06
	8 m	ED	BSB 35-50 Rundsteckverbinder 7-pol.	Standard	7S1SK083010012B06
	4 m	ED	BSB 35-50 Rundsteckverbinder 7-pol.	High Flex Leder	7S1SH043010012B06
	8 m	ED	BSB 35-50 Rundsteckverbinder 7-pol.	High Flex Leder	7S1SH083010012B06
ABITIG® 9F	4 m	ED	BSB 35-50 Rundsteckverbinder 7-pol.	Standard	7S1FK043010012B06
	8 m	ED	BSB 35-50 Rundsteckverbinder 7-pol.	Standard	7S1FK083010012B06
	4 m	ED	BSB 35-50 Rundsteckverbinder 7-pol.	High Flex Leder	7S1FH043010012B06
	8 m	ED	BSB 35-50 Rundsteckverbinder 7-pol.	High Flex Leder	7S1FH083010012B06
ABITIG® 17	4 m	ED	BSB 35-50 Rundsteckverbinder 7-pol.	Standard	7S2SK043010012B06
	8 m	ED	BSB 35-50 Rundsteckverbinder 7-pol.	Standard	7S2SK083010012B06
	4 m	ED	BSB 35-50 Rundsteckverbinder 7-pol.	High Flex Leder	7S2SH043010012B06
	8 m	ED	BSB 35-50 Rundsteckverbinder 7-pol.	High Flex Leder	7S2SH083010012B06
ABITIG® 17F	4 m	ED	BSB 35-50 Rundsteckverbinder 7-pol.	Standard	7S2FK043010012B06
	8 m	ED	BSB 35-50 Rundsteckverbinder 7-pol.	Standard	7S2FK083010012B06
	4 m	ED	BSB 35-50 Rundsteckverbinder 7-pol.	High Flex Leder	7S2FH043010012B06
	8 m	ED	BSB 35-50 Rundsteckverbinder 7-pol.	High Flex Leder	7S2FH083010012B06

Technische Änderungen vorbehalten • Verkaufspreise = unverbindliche Preisempfehlung - Angebot freibleibend • © Copyright

ABITIG®-Brennerpreisliste

passend für WIG-Stromquellen des Fabrikates „bester“

Brennertyp	Länge	Schalterfunktion	maschinenseitiger Anschluss	Schlauchpaketausführung	Bestellnummer
ABITIG® 26	4 m	ED	BSB 35-50 Rundsteckverbinder 7-pol.	Standard	7S3SK043010012B06
	8 m	ED	BSB 35-50 Rundsteckverbinder 7-pol.	Standard	7S3SK083010012B06
	4 m	ED	BSB 35-50 Rundsteckverbinder 7-pol.	High Flex Leder	7S3SH043010012B06
	8 m	ED	BSB 35-50 Rundsteckverbinder 7-pol.	High Flex Leder	7S3SH083010012B06
ABITIG® 26F	4 m	ED	BSB 35-50 Rundsteckverbinder 7-pol.	Standard	7S3FK043010012B06
	8 m	ED	BSB 35-50 Rundsteckverbinder 7-pol.	Standard	7S3FK083010012B06
	4 m	ED	BSB 35-50 Rundsteckverbinder 7-pol.	High Flex Leder	7S3FH043010012B06
	8 m	ED	BSB 35-50 Rundsteckverbinder 7-pol.	High Flex Leder	7S3FH083010012B06
ABITIG® 24G	4 m	ED	BSB 35-50 Rundsteckverbinder 7-pol.	Standard	7S8SK043010012B06
	8 m	ED	BSB 35-50 Rundsteckverbinder 7-pol.	Standard	7S8SK083010012B06
	8 m	ED	BSB 35-50 Rundsteckverbinder 7-pol.	High Flex Leder	7S8SH043010012B06
	4 m	ED	BSB 35-50 Rundsteckverbinder 7-pol.	High Flex Leder	7S8SH083010012B06
ABITIG® 200	4 m	ED	BSB 35-50 Rundsteckverbinder 7-pol.	Standard	7T4SK043010012B06
	8 m	ED	BSB 35-50 Rundsteckverbinder 7-pol.	Standard	7T4SK083010012B06
	4 m	ED	BSB 35-50 Rundsteckverbinder 7-pol.	High Flex Leder	7T4SH043010012B06
	8 m	ED	BSB 35-50 Rundsteckverbinder 7-pol.	High Flex Leder	7T4SH083010012B06
ABITIG® 200F	4 m	ED	BSB 35-50 Rundsteckverbinder 7-pol.	Standard	7T4FK043010012B06
	8 m	ED	BSB 35-50 Rundsteckverbinder 7-pol.	Standard	7T4FK083010012B06
	4 m	ED	BSB 35-50 Rundsteckverbinder 7-pol.	High Flex Leder	7T4FH043010012B06
	8 m	ED	BSB 35-50 Rundsteckverbinder 7-pol.	High Flex Leder	7T4FH083010012B06
ABITIG® 150	4 m	ED	BSB 35-50 Rundsteckverbinder 7-pol.	Standard	7T6SK043010012B06
	8 m	ED	BSB 35-50 Rundsteckverbinder 7-pol.	Standard	7T6SK083010012B06
	4 m	ED	BSB 35-50 Rundsteckverbinder 7-pol.	High Flex Leder	7T6SH043010012B06
	8 m	ED	BSB 35-50 Rundsteckverbinder 7-pol.	High Flex Leder	7T6SH083010012B06
ABITIG® 150F	4 m	ED	BSB 35-50 Rundsteckverbinder 7-pol.	Standard	7T6FK043010012B06
	8 m	ED	BSB 35-50 Rundsteckverbinder 7-pol.	Standard	7T6FK083010012B06
	4 m	ED	BSB 35-50 Rundsteckverbinder 7-pol.	High Flex Leder	7T6FH043010012B06
	8 m	ED	BSB 35-50 Rundsteckverbinder 7-pol.	High Flex Leder	7T6FH083010012B06

ABITIG®-Brennerpreisliste

passend für WIG-Stromquellen des Fabrikates „bester“

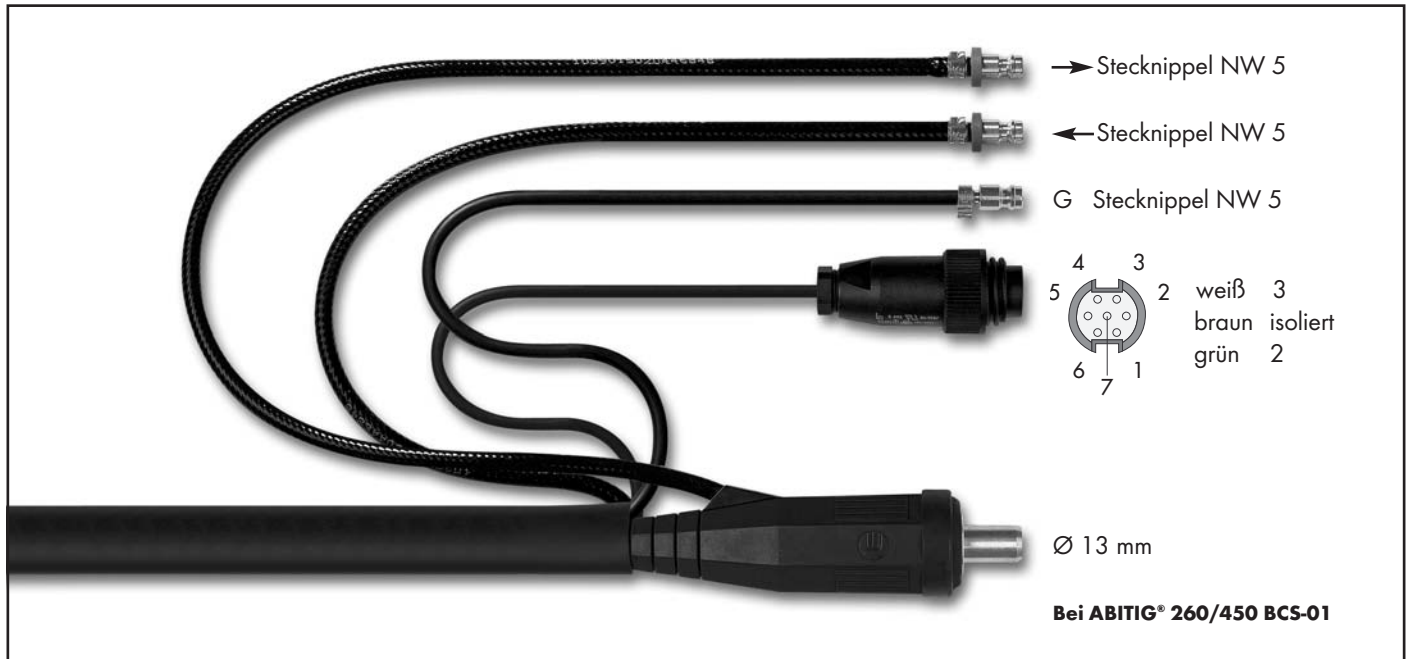

Brennertyp	Länge	Schalterfunktion	maschinenseitiger Anschluss	Schlauchpaketausführung	Bestellnummer
ABITIG® 18	4 m	ED	BSB 35-50 Rundsteckverbinder 7-pol.	Standard	7S4SK043010012B20
	8 m	ED	BSB 35-50 Rundsteckverbinder 7-pol.	Standard	7S4SK083010012B20
	4 m	ED	BSB 35-50 Rundsteckverbinder 7-pol.	High Flex Leder	7S4SH043010012B20
	8 m	ED	BSB 35-50 Rundsteckverbinder 7-pol.	High Flex Leder	7S4SH083010012B20
ABITIG® 18F	4 m	ED	BSB 35-50 Rundsteckverbinder 7-pol.	Standard	7S4FK043010012B20
	8 m	ED	BSB 35-50 Rundsteckverbinder 7-pol.	Standard	7S4FK083010012B20
	4 m	ED	BSB 35-50 Rundsteckverbinder 7-pol.	High Flex Leder	7S4FH043010012B20
	8 m	ED	BSB 35-50 Rundsteckverbinder 7-pol.	High Flex Leder	7S4FH083010012B20
ABITIG® 20	4 m	ED	BSB 35-50 Rundsteckverbinder 7-pol.	Standard	7S5SK043010012B20
	8 m	ED	BSB 35-50 Rundsteckverbinder 7-pol.	Standard	7S5SK083010012B20
	4 m	ED	BSB 35-50 Rundsteckverbinder 7-pol.	High Flex Leder	7S5SH043010012B20
	8 m	ED	BSB 35-50 Rundsteckverbinder 7-pol.	High Flex Leder	7S5SH083010012B20
ABITIG® 20F	4 m	ED	BSB 35-50 Rundsteckverbinder 7-pol.	Standard	7S5FK043010012B20
	8 m	ED	BSB 35-50 Rundsteckverbinder 7-pol.	Standard	7S5FK083010012B20
	4 m	ED	BSB 35-50 Rundsteckverbinder 7-pol.	High Flex Leder	7S5FH043010012B20
	8 m	ED	BSB 35-50 Rundsteckverbinder 7-pol.	High Flex Leder	7S5FH083010012B20

Technische Änderungen vorbehalten • Verkaufspreise = unverbindliche Preisempfehlung - Angebot freibleibend • © Copyright

ABITIG®-Brennerpreisliste

passend für WIG-Stromquellen des Fabrikates „bester“

Brennertyp	Länge	Schalterfunktion	maschinenseitiger Anschluss	Schlauchpaketausführung	Bestellnummer
ABITIG® 12-1	4 m	ED	BSB 35-50 Rundsteckverbinder 7-pol.	Standard	7S6SK043010012B20
	8 m	ED	BSB 35-50 Rundsteckverbinder 7-pol.	Standard	7S6SK083010012B20
	4 m	ED	BSB 35-50 Rundsteckverbinder 7-pol.	High Flex Leder	7S6SH043010012B20
	8 m	ED	BSB 35-50 Rundsteckverbinder 7-pol.	High Flex Leder	7S6SH083010012B20
ABITIG® 18SC	4 m	ED	BSB 35-50 Rundsteckverbinder 7-pol.	Standard	7S7SK043010012B20
	8 m	ED	BSB 35-50 Rundsteckverbinder 7-pol.	Standard	7S7SK083010012B20
	4 m	ED	BSB 35-50 Rundsteckverbinder 7-pol.	High Flex Leder	7S7SH043010012B20
	8 m	ED	BSB 35-50 Rundsteckverbinder 7-pol.	High Flex Leder	7S7SH083010012B20
ABITIG® 24W	4 m	ED	BSB 35-50 Rundsteckverbinder 7-pol.	Standard	7S9SK043010012B20
	8 m	ED	BSB 35-50 Rundsteckverbinder 7-pol.	Standard	7S9SK083010012B20
	4 m	ED	BSB 35-50 Rundsteckverbinder 7-pol.	High Flex Leder	7S9SH043010012B20
	8 m	ED	BSB 35-50 Rundsteckverbinder 7-pol.	High Flex Leder	7S9SH083010012B20
ABITIG® 450W	4 m	ED	BSB 35-50 Rundsteckverbinder 7-pol.	Standard	7T5SK043010112B20
	8 m	ED	BSB 35-50 Rundsteckverbinder 7-pol.	Standard	7T5SK083010112B20
	4 m	ED	BSB 35-50 Rundsteckverbinder 7-pol.	High Flex Leder	7T5SH043010112B20
	8 m	ED	BSB 35-50 Rundsteckverbinder 7-pol.	High Flex Leder	7T5SH083010112B20
ABITIG® 260W	4 m	ED	BSB 35-50 Rundsteckverbinder 7-pol.	Standard	7T7SK043010112B20
	8 m	ED	BSB 35-50 Rundsteckverbinder 7-pol.	Standard	7T7SK083010112B20
	4 m	ED	BSB 35-50 Rundsteckverbinder 7-pol.	High Flex Leder	7T7SH043010112B20
	8 m	ED	BSB 35-50 Rundsteckverbinder 7-pol.	High Flex Leder	7T7SH083010112B20
ABITIG® 450W SC	4 m	ED	BSB 35-50 Rundsteckverbinder 7-pol.	Standard	
	8 m	ED	BSB 35-50 Rundsteckverbinder 7-pol.	Standard	
	4 m	ED	BSB 35-50 Rundsteckverbinder 7-pol.	High Flex Leder	7T8SH043010112B20
	8 m	ED	BSB 35-50 Rundsteckverbinder 7-pol.	High Flex Leder	7T8SH083010112B20

ABITIG®-Brennerpreisliste

passend für WIG-Stromquellen des Fabrikates „castolin“



Brennertyp	Länge	Schalterfunktion	maschinenseitiger Anschluss	Schlauchpaketausführung	Bestellnummer
ABITIG® 9	4 m	DD	ZA - GZ Tuchel 5-pol.	Standard	7S1SK043020301A00
	8 m	DD	ZA - GZ Tuchel 5-pol.	Standard	7S1SK083020301A00
	4 m	DD	ZA - GZ Tuchel 5-pol.	High Flex Leder	7S1SH043020301A00
	8 m	DD	ZA - GZ Tuchel 5-pol.	High Flex Leder	7S1SH083020301A00

ABITIG® 9F	4 m	DD	ZA - GZ Tuchel 5-pol.	Standard	7S1FK043020301A00
	8 m	DD	ZA - GZ Tuchel 5-pol.	Standard	7S1FK083020301A00
	4 m	DD	ZA - GZ Tuchel 5-pol.	High Flex Leder	7S1FH043020301A00
	8 m	DD	ZA - GZ Tuchel 5-pol.	High Flex Leder	7S1FH083020301A00

ABITIG® 17	4 m	DD	ZA - GZ Tuchel 5-pol.	Standard	7S2SK043020301A00
	8 m	DD	ZA - GZ Tuchel 5-pol.	Standard	7S2SK083020301A00
	4 m	DD	ZA - GZ Tuchel 5-pol.	High Flex Leder	7S2SH043020301A00
	8 m	DD	ZA - GZ Tuchel 5-pol.	High Flex Leder	7S2SH083020301A00

ABITIG® 17F	4 m	DD	ZA - GZ Tuchel 5-pol.	Standard	7S2FK043020301A00
	8 m	DD	ZA - GZ Tuchel 5-pol.	Standard	7S2FK083020301A00
	4 m	DD	ZA - GZ Tuchel 5-pol.	High Flex Leder	7S2FH043020301A00
	8 m	DD	ZA - GZ Tuchel 5-pol.	High Flex Leder	7S2FH083020301A00

Technische Änderungen vorbehalten • Verkaufspreise = unverbindliche Preisempfehlung - Angebot freibleibend • © Copyright

ABITIG®-Brennerpreisliste

passend für WIG-Stromquellen des Fabrikates „castolin“

Brennertyp	Länge	Schalterfunktion	maschinenseitiger Anschluss	Schlauchpaketausführung	Bestellnummer
ABITIG® 26	4 m	DD	ZA - GZ Tuchel 5-pol.	Standard	7S3SK043020301A00
	8 m	DD	ZA - GZ Tuchel 5-pol.	Standard	7S3SK083020301A00
	4 m	DD	ZA - GZ Tuchel 5-pol.	High Flex Leder	7S3SH043020301A00
	8 m	DD	ZA - GZ Tuchel 5-pol.	High Flex Leder	7S3SH083020301A00
ABITIG® 26F	4 m	DD	ZA - GZ Tuchel 5-pol.	Standard	7S3FK043020301A00
	8 m	DD	ZA - GZ Tuchel 5-pol.	Standard	7S3FK083020301A00
	4 m	DD	ZA - GZ Tuchel 5-pol.	High Flex Leder	7S3FH043020301A00
	8 m	DD	ZA - GZ Tuchel 5-pol.	High Flex Leder	7S3FH083020301A00
ABITIG® 24G	4 m	DD	ZA - GZ Tuchel 5-pol.	Standard	7S8SK043020301A00
	8 m	DD	ZA - GZ Tuchel 5-pol.	Standard	7S8SK083020301A00
	4 m	DD	ZA - GZ Tuchel 5-pol.	High Flex Leder	7S8SH043020301A00
	8 m	DD	ZA - GZ Tuchel 5-pol.	High Flex Leder	7S8SH083020301A00
ABITIG® 200	4 m	DD	ZA - GZ Tuchel 5-pol.	Standard	7T4SK043020301A00
	8 m	DD	ZA - GZ Tuchel 5-pol.	Standard	7T4SK083020301A00
	4 m	DD	ZA - GZ Tuchel 5-pol.	High Flex Leder	7T4SH043020301A00
	8 m	DD	ZA - GZ Tuchel 5-pol.	High Flex Leder	7T4SH083020301A00
ABITIG® 200F	4 m	DD	ZA - GZ Tuchel 5-pol.	Standard	7T4FK043020301A00
	8 m	DD	ZA - GZ Tuchel 5-pol.	Standard	7T4FK083020301A00
	4 m	DD	ZA - GZ Tuchel 5-pol.	High Flex Leder	7T4FH043020301A00
	8 m	DD	ZA - GZ Tuchel 5-pol.	High Flex Leder	7T4FH083020301A00
ABITIG® 150	4 m	DD	ZA - GZ Tuchel 5-pol.	Standard	7T6SK043020301A00
	8 m	DD	ZA - GZ Tuchel 5-pol.	Standard	7T6SK083020301A00
	4 m	DD	ZA - GZ Tuchel 5-pol.	High Flex Leder	7T6SH043020301A00
	8 m	DD	ZA - GZ Tuchel 5-pol.	High Flex Leder	7T6SH083020301A00
ABITIG® 150F	4 m	DD	ZA - GZ Tuchel 5-pol.	Standard	7T6FK043020301A00
	8 m	DD	ZA - GZ Tuchel 5-pol.	Standard	7T6FK083020301A00
	4 m	DD	ZA - GZ Tuchel 5-pol.	High Flex Leder	7T6FH043020301A00
	8 m	DD	ZA - GZ Tuchel 5-pol.	High Flex Leder	7T6FH083020301A00

ABITIG®-Brennerpreisliste

passend für WIG-Stromquellen des Fabrikates „castolin“



Brennertyp	Länge	Schalterfunktion	maschinenseitiger Anschluss	Schlauchpaketausführung	Bestellnummer
ABITIG® 9	4 m	ED	ZA - GZ Tuchel 5-pol.	Standard	7S1SK043010306A00
	8 m	ED	ZA - GZ Tuchel 5-pol.	Standard	7S1SK083010306A00
	4 m	ED	ZA - GZ Tuchel 5-pol.	High Flex Leder	7S1SH043010306A00
	8 m	ED	ZA - GZ Tuchel 5-pol.	High Flex Leder	7S1SH083010306A00
ABITIG® 9F	4 m	ED	ZA - GZ Tuchel 5-pol.	Standard	7S1FK043010306A00
	8 m	ED	ZA - GZ Tuchel 5-pol.	Standard	7S1FK083010306A00
	4 m	ED	ZA - GZ Tuchel 5-pol.	High Flex Leder	7S1FH043010306A00
	8 m	ED	ZA - GZ Tuchel 5-pol.	High Flex Leder	7S1FH083010306A00
ABITIG® 17	4 m	ED	ZA - GZ Tuchel 5-pol.	Standard	7S2SK043010306A00
	8 m	ED	ZA - GZ Tuchel 5-pol.	Standard	7S2SK083010306A00
	4 m	ED	ZA - GZ Tuchel 5-pol.	High Flex Leder	7S2SH043010306A00
	8 m	ED	ZA - GZ Tuchel 5-pol.	High Flex Leder	7S2SH083010306A00
ABITIG® 17F	4 m	ED	ZA - GZ Tuchel 5-pol.	Standard	7S2FK043010306A00
	8 m	ED	ZA - GZ Tuchel 5-pol.	Standard	7S2FK083010306A00
	4 m	ED	ZA - GZ Tuchel 5-pol.	High Flex Leder	7S2FH043010306A00
	8 m	ED	ZA - GZ Tuchel 5-pol.	High Flex Leder	7S2FH083010306A00

Technische Änderungen vorbehalten • Verkaufspreise = unverbindliche Preisempfehlung - Angebot freibleibend • © Copyright

ABITIG®-Brennerpreisliste

passend für WIG-Stromquellen des Fabrikates „castolin“

Brennertyp	Länge	Schalterfunktion	maschinenseitiger Anschluss	Schlauchpaketausführung	Bestellnummer
ABITIG® 26	4 m	ED	ZA - GZ Tuchel 5-pol.	Standard	7S3SK043010306A00
	8 m	ED	ZA - GZ Tuchel 5-pol.	Standard	7S3SK083010306A00
	4 m	ED	ZA - GZ Tuchel 5-pol.	High Flex Leder	7S3SH043010306A00
	8 m	ED	ZA - GZ Tuchel 5-pol.	High Flex Leder	7S3SH083010306A00
ABITIG® 26F	4 m	ED	ZA - GZ Tuchel 5-pol.	Standard	7S3FK043010306A00
	8 m	ED	ZA - GZ Tuchel 5-pol.	Standard	7S3FK083010306A00
	4 m	ED	ZA - GZ Tuchel 5-pol.	High Flex Leder	7S3FH043010306A00
	8 m	ED	ZA - GZ Tuchel 5-pol.	High Flex Leder	7S3FH083010306A00
ABITIG® 24G	4 m	ED	ZA - GZ Tuchel 5-pol.	Standard	7S8SK043010306A00
	8 m	ED	ZA - GZ Tuchel 5-pol.	Standard	7S8SK083010306A00
	4 m	ED	ZA - GZ Tuchel 5-pol.	High Flex Leder	7S8SH043010306A00
	8 m	ED	ZA - GZ Tuchel 5-pol.	High Flex Leder	7S8SH083010306A00
ABITIG® 200	4 m	ED	ZA - GZ Tuchel 5-pol.	Standard	7T4SK043010306A00
	8 m	ED	ZA - GZ Tuchel 5-pol.	Standard	7T4SK083010306A00
	4 m	ED	ZA - GZ Tuchel 5-pol.	High Flex Leder	7T4SH043010306A00
	8 m	ED	ZA - GZ Tuchel 5-pol.	High Flex Leder	7T4SH083010306A00
ABITIG® 200F	4 m	ED	ZA - GZ Tuchel 5-pol.	Standard	7T4FK043010306A00
	8 m	ED	ZA - GZ Tuchel 5-pol.	Standard	7T4FK083010306A00
	4 m	ED	ZA - GZ Tuchel 5-pol.	High Flex Leder	7T4FH043010306A00
	8 m	ED	ZA - GZ Tuchel 5-pol.	High Flex Leder	7T4FH083010306A00
ABITIG® 150	4 m	ED	ZA - GZ Tuchel 5-pol.	Standard	7T6SK043010306A00
	8 m	ED	ZA - GZ Tuchel 5-pol.	Standard	7T6SK083010306A00
	4 m	ED	ZA - GZ Tuchel 5-pol.	High Flex Leder	7T6SH043010306A00
	8 m	ED	ZA - GZ Tuchel 5-pol.	High Flex Leder	7T6SH083010306A00
ABITIG® 150F	4 m	ED	ZA - GZ Tuchel 5-pol.	Standard	7T6FK043010306A00
	8 m	ED	ZA - GZ Tuchel 5-pol.	Standard	7T6FK083010306A00
	4 m	ED	ZA - GZ Tuchel 5-pol.	High Flex Leder	7T6FH043010306A00
	8 m	ED	ZA - GZ Tuchel 5-pol.	High Flex Leder	7T6FH083010306A00

ABITIG®-Brennerpreisliste

passend für WIG-Stromquellen des Fabrikates „castolin“



Brennertyp	Länge	Schalterfunktion	maschinenseitiger Anschluss	Schlauchpaketausführung	Bestellnummer
ABITIG® 9	4 m	DD	ZA - GZ Tuchel 7-pol.	Standard	7S1SK043020334A00
	8 m	DD	ZA - GZ Tuchel 7-pol.	Standard	7S1SK083020334A00
	4 m	DD	ZA - GZ Tuchel 7-pol.	High Flex Leder	7S1SH043020334A00
	8 m	DD	ZA - GZ Tuchel 7-pol.	High Flex Leder	7S1SH083020334A00

ABITIG® 9F	4 m	DD	ZA - GZ Tuchel 7-pol.	Standard	7S1FK043020334A00
	8 m	DD	ZA - GZ Tuchel 7-pol.	Standard	7S1FK083020334A00
	4 m	DD	ZA - GZ Tuchel 7-pol.	High Flex Leder	7S1FH043020334A00
	8 m	DD	ZA - GZ Tuchel 7-pol.	High Flex Leder	7S1FH083020334A00

ABITIG® 17	4 m	DD	ZA - GZ Tuchel 7-pol.	Standard	7S2SK043020334A00
	8 m	DD	ZA - GZ Tuchel 7-pol.	Standard	7S2SK083020334A00
	4 m	DD	ZA - GZ Tuchel 7-pol.	High Flex Leder	7S2SH043020334A00
	8 m	DD	ZA - GZ Tuchel 7-pol.	High Flex Leder	7S2SH083020334A00

ABITIG® 17F	4 m	DD	ZA - GZ Tuchel 7-pol.	Standard	7S2FK043020334A00
	8 m	DD	ZA - GZ Tuchel 7-pol.	Standard	7S2FK083020334A00
	4 m	DD	ZA - GZ Tuchel 7-pol.	High Flex Leder	7S2FH043020334A00
	8 m	DD	ZA - GZ Tuchel 7-pol.	High Flex Leder	7S2FH083020334A00

Technische Änderungen vorbehalten • Verkaufspreise = unverbindliche Preisempfehlung - Angebot freibleibend • © Copyright

ABITIG®-Brennerpreisliste

passend für WIG-Stromquellen des Fabrikates „castolin“

Brennertyp	Länge	Schalterfunktion	maschinenseitiger Anschluss	Schlauchpaketausführung	Bestellnummer
ABITIG® 26	4 m	DD	ZA - GZ Tuchel 7-pol.	Standard	7S3SK043020334A00
	8 m	DD	ZA - GZ Tuchel 7-pol.	Standard	7S3SK083020334A00
	4 m	DD	ZA - GZ Tuchel 7-pol.	High Flex Leder	7S3SH043020334A00
	8 m	DD	ZA - GZ Tuchel 7-pol.	High Flex Leder	7S3SH083020334A00

ABITIG® 26F	4 m	DD	ZA - GZ Tuchel 7-pol.	Standard	7S3FK043020334A00
	8 m	DD	ZA - GZ Tuchel 7-pol.	Standard	7S3FK083020334A00
	4 m	DD	ZA - GZ Tuchel 7-pol.	High Flex Leder	7S3FH043020334A00
	8 m	DD	ZA - GZ Tuchel 7-pol.	High Flex Leder	7S3FH083020334A00

ABITIG® 24G	4 m	DD	ZA - GZ Tuchel 7-pol.	Standard	7S8SK043020334A00
	8 m	DD	ZA - GZ Tuchel 7-pol.	Standard	7S8SK083020334A00
	4 m	DD	ZA - GZ Tuchel 7-pol.	High Flex Leder	7S8SH043020334A00
	8 m	DD	ZA - GZ Tuchel 7-pol.	High Flex Leder	7S8SH083020334A00

ABITIG® 200	4 m	DD	ZA - GZ Tuchel 7-pol.	Standard	7T4SK043020334A00
	8 m	DD	ZA - GZ Tuchel 7-pol.	Standard	7T4SK083020334A00
	4 m	DD	ZA - GZ Tuchel 7-pol.	High Flex Leder	7T4SH043020334A00
	8 m	DD	ZA - GZ Tuchel 7-pol.	High Flex Leder	7T4SH083020334A00

ABITIG® 200F	4 m	DD	ZA - GZ Tuchel 7-pol.	Standard	7T4FK043020334A00
	8 m	DD	ZA - GZ Tuchel 7-pol.	Standard	7T4FK083020334A00
	4 m	DD	ZA - GZ Tuchel 7-pol.	High Flex Leder	7T4FH043020334A00
	8 m	DD	ZA - GZ Tuchel 7-pol.	High Flex Leder	7T4FH083020334A00

ABITIG® 150	4 m	DD	ZA - GZ Tuchel 7-pol.	Standard	7T6SK043020334A00
	8 m	DD	ZA - GZ Tuchel 7-pol.	Standard	7T6SK083020334A00
	4 m	DD	ZA - GZ Tuchel 7-pol.	High Flex Leder	7T6SH043020334A00
	8 m	DD	ZA - GZ Tuchel 7-pol.	High Flex Leder	7T6SH083020334A00

ABITIG® 150F	4 m	DD	ZA - GZ Tuchel 7-pol.	Standard	7T6FK043020334A00
	8 m	DD	ZA - GZ Tuchel 7-pol.	Standard	7T6FK083020334A00
	4 m	DD	ZA - GZ Tuchel 7-pol.	High Flex Leder	7T6FH043020334A00
	8 m	DD	ZA - GZ Tuchel 7-pol.	High Flex Leder	7T6FH083020334A00

ABITIG®-Brennerpreisliste

passend für WIG-Stromquellen des Fabrikates „castolin“ Up/Down



Brennertyp	Länge	Schalterfunktion	maschinenseitiger Anschluss	Schlauchpaketausführung	Bestellnummer
ABITIG® 9	4 m	UD	ZA - GZ Tuchel 7-pol.	Standard	7S1SK046150318A00
	8 m	UD	ZA - GZ Tuchel 7-pol.	Standard	7S1SK086150318A00
	4 m	UD	ZA - GZ Tuchel 7-pol.	High Flex Leder	7S1SH046150318A00
	8 m	UD	ZA - GZ Tuchel 7-pol.	High Flex Leder	7S1SH086150318A00

ABITIG® 9F	4 m	UD	ZA - GZ Tuchel 7-pol.	Standard	7S1FK046150318A00
	8 m	UD	ZA - GZ Tuchel 7-pol.	Standard	7S1FK086150318A00
	4 m	UD	ZA - GZ Tuchel 7-pol.	High Flex Leder	7S1FH046150318A00
	8 m	UD	ZA - GZ Tuchel 7-pol.	High Flex Leder	7S1FH086150318A00

ABITIG® 17	4 m	UD	ZA - GZ Tuchel 7-pol.	Standard	7S2SK046150318A00
	8 m	UD	ZA - GZ Tuchel 7-pol.	Standard	7S2SK086150318A00
	4 m	UD	ZA - GZ Tuchel 7-pol.	High Flex Leder	7S2SH046150318A00
	8 m	UD	ZA - GZ Tuchel 7-pol.	High Flex Leder	7S2SH086150318A00

ABITIG® 17F	4 m	UD	ZA - GZ Tuchel 7-pol.	Standard	7S2FK046150318A00
	8 m	UD	ZA - GZ Tuchel 7-pol.	Standard	7S2FK086150318A00
	4 m	UD	ZA - GZ Tuchel 7-pol.	High Flex Leder	7S2FH046150318A00
	8 m	UD	ZA - GZ Tuchel 7-pol.	High Flex Leder	7S2FH086150318A00

Technische Änderungen vorbehalten • Verkaufspreise = unverbindliche Preisempfehlung - Angebot freibleibend • © Copyright

ABITIG®-Brennerpreisliste

passend für WIG-Stromquellen des Fabrikates „castolin“ Up/Down

Brennertyp	Länge	Schalterfunktion	maschinenseitiger Anschluss	Schlauchpaketausführung	Bestellnummer
ABITIG® 26	4 m	UD	ZA - GZ Tuchel 7-pol.	Standard	7S3SK046150318A00
	8 m	UD	ZA - GZ Tuchel 7-pol.	Standard	7S3SK086150318A00
	4 m	UD	ZA - GZ Tuchel 7-pol.	High Flex Leder	7S3SH046150318A00
	8 m	UD	ZA - GZ Tuchel 7-pol.	High Flex Leder	7S3SH086150318A00
ABITIG® 26F	4 m	UD	ZA - GZ Tuchel 7-pol.	Standard	7S3FK046150318A00
	8 m	UD	ZA - GZ Tuchel 7-pol.	Standard	7S3FK086150318A00
	4 m	UD	ZA - GZ Tuchel 7-pol.	High Flex Leder	7S3FH046150318A00
	8 m	UD	ZA - GZ Tuchel 7-pol.	High Flex Leder	7S3FH086150318A00
ABITIG® 24G	4 m	UD	ZA - GZ Tuchel 7-pol.	Standard	7S8SK046150318A00
	8 m	UD	ZA - GZ Tuchel 7-pol.	Standard	7S8SK086150318A00
	4 m	UD	ZA - GZ Tuchel 7-pol.	High Flex Leder	7S8SH046150318A00
	8 m	UD	ZA - GZ Tuchel 7-pol.	High Flex Leder	7S8SH086150318A00
ABITIG® 200	4 m	UD	ZA - GZ Tuchel 7-pol.	Standard	7T4SK046150318A00
	8 m	UD	ZA - GZ Tuchel 7-pol.	Standard	7T4SK086150318A00
	4 m	UD	ZA - GZ Tuchel 7-pol.	High Flex Leder	7T4SH046150318A00
	8 m	UD	ZA - GZ Tuchel 7-pol.	High Flex Leder	7T4SH086150318A00
ABITIG® 200F	4 m	UD	ZA - GZ Tuchel 7-pol.	Standard	7T4FK046150318A00
	8 m	UD	ZA - GZ Tuchel 7-pol.	Standard	7T4FK086150318A00
	4 m	UD	ZA - GZ Tuchel 7-pol.	High Flex Leder	7T4FH046150318A00
	8 m	UD	ZA - GZ Tuchel 7-pol.	High Flex Leder	7T4FH086150318A00
ABITIG® 150	4 m	UD	ZA - GZ Tuchel 7-pol.	Standard	7T6SK046150318A00
	8 m	UD	ZA - GZ Tuchel 7-pol.	Standard	7T6SK086150318A00
	4 m	UD	ZA - GZ Tuchel 7-pol.	High Flex Leder	7T6SH046150318A00
	8 m	UD	ZA - GZ Tuchel 7-pol.	High Flex Leder	7T6SH086150318A00
ABITIG® 150F	4 m	UD	ZA - GZ Tuchel 7-pol.	Standard	7T6FK046150318A00
	8 m	UD	ZA - GZ Tuchel 7-pol.	Standard	7T6FK086150318A00
	4 m	UD	ZA - GZ Tuchel 7-pol.	High Flex Leder	7T6FH046150318A00
	8 m	UD	ZA - GZ Tuchel 7-pol.	High Flex Leder	7T6FH086150318A00

ABITIG®-Brennerpreisliste

passend für WIG-Stromquellen des Fabrikates „castolin“ Up/Down

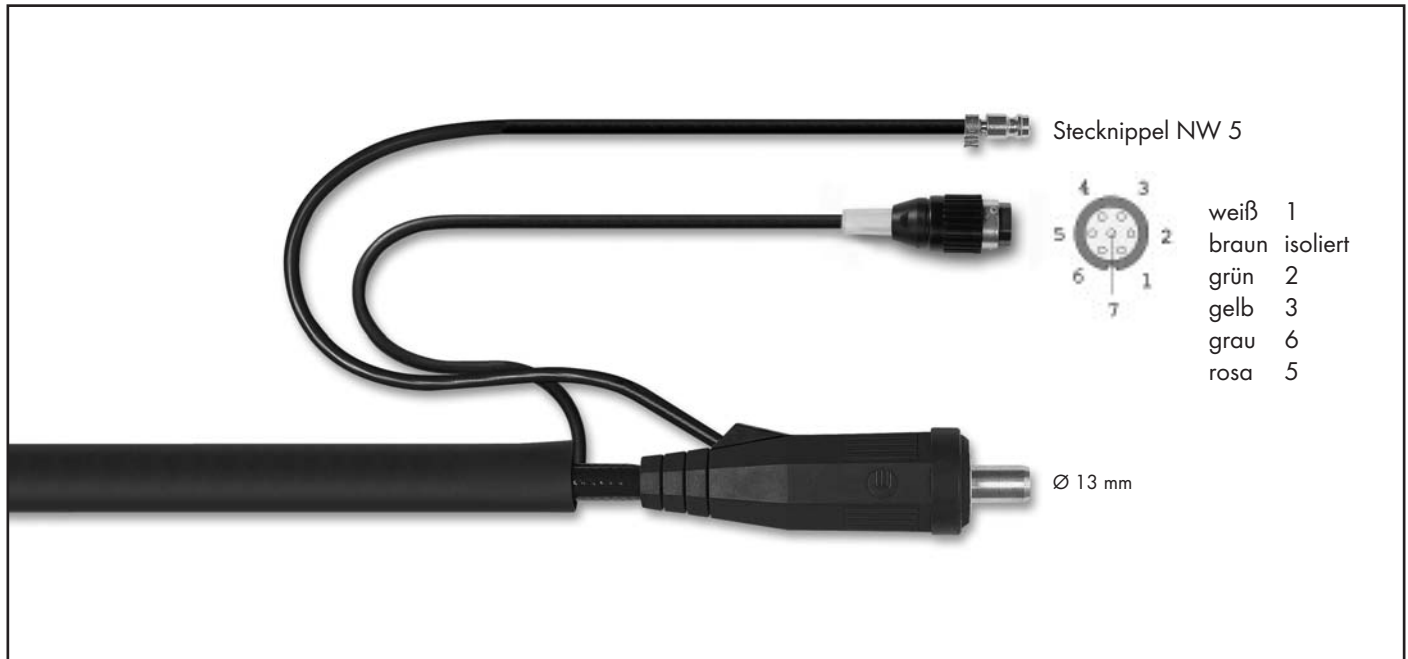

Brennertyp	Länge	Schalterfunktion	maschinenseitiger Anschluss	Schlauchpaketausführung	Bestellnummer
ABITIG® 9	4 m	UD	BSB 35-50 Tuchel 7-pol.	Standard	7S1SK046150018A06
	8 m	UD	BSB 35-50 Tuchel 7-pol.	Standard	7S1SK086150018A06
	4 m	UD	BSB 35-50 Tuchel 7-pol.	High Flex Leder	7S1SH046150018A06
	8 m	UD	BSB 35-50 Tuchel 7-pol.	High Flex Leder	7S1SH086150018A06
ABITIG® 9F	4 m	UD	BSB 35-50 Tuchel 7-pol.	Standard	7S1FK046150018A06
	8 m	UD	BSB 35-50 Tuchel 7-pol.	Standard	7S1FK086150018A06
	4 m	UD	BSB 35-50 Tuchel 7-pol.	High Flex Leder	7S1FH046150018A06
	8 m	UD	BSB 35-50 Tuchel 7-pol.	High Flex Leder	7S1FH086150018A06
ABITIG® 17	4 m	UD	BSB 35-50 Tuchel 7-pol.	Standard	7S2SK046150018A06
	8 m	UD	BSB 35-50 Tuchel 7-pol.	Standard	7S2SK086150018A06
	4 m	UD	BSB 35-50 Tuchel 7-pol.	High Flex Leder	7S2SH046150018A06
	8 m	UD	BSB 35-50 Tuchel 7-pol.	High Flex Leder	7S2SH086150018A06
ABITIG® 17F	4 m	UD	BSB 35-50 Tuchel 7-pol.	Standard	7S2FK046150018A06
	8 m	UD	BSB 35-50 Tuchel 7-pol.	Standard	7S2FK086150018A06
	4 m	UD	BSB 35-50 Tuchel 7-pol.	High Flex Leder	7S2FH046150018A06
	8 m	UD	BSB 35-50 Tuchel 7-pol.	High Flex Leder	7S2FH086150018A06

Technische Änderungen vorbehalten • Verkaufspreise = unverbindliche Preisempfehlung - Angebot freibleibend • © Copyright

ABITIG®-Brennerpreisliste

passend für WIG-Stromquellen des Fabrikates „castolin“ Up/Down

Brennertyp	Länge	Schalterfunktion	maschinenseitiger Anschluss	Schlauchpaketausführung	Bestellnummer
ABITIG® 26	4 m	UD	BSB 35-50 Tuchel 7-pol.	Standard	7S3SK046150018A06
	8 m	UD	BSB 35-50 Tuchel 7-pol.	Standard	7S3SK086150018A06
	4 m	UD	BSB 35-50 Tuchel 7-pol.	High Flex Leder	7S3SH046150018A06
	8 m	UD	BSB 35-50 Tuchel 7-pol.	High Flex Leder	7S3SH086150018A06
ABITIG® 26F	4 m	UD	BSB 35-50 Tuchel 7-pol.	Standard	7S3FK046150018A06
	8 m	UD	BSB 35-50 Tuchel 7-pol.	Standard	7S3FK086150018A06
	4 m	UD	BSB 35-50 Tuchel 7-pol.	High Flex Leder	7S3FH046150018A06
	8 m	UD	BSB 35-50 Tuchel 7-pol.	High Flex Leder	7S3FH086150018A06
ABITIG® 24G	4 m	UD	BSB 35-50 Tuchel 7-pol.	Standard	7S8SK046150018A06
	8 m	UD	BSB 35-50 Tuchel 7-pol.	Standard	7S8SK086150018A06
	4 m	UD	BSB 35-50 Tuchel 7-pol.	High Flex Leder	7S8SH046150018A06
	8 m	UD	BSB 35-50 Tuchel 7-pol.	High Flex Leder	7S8SH086150018A06
ABITIG® 200	4 m	UD	BSB 35-50 Tuchel 7-pol.	Standard	7T4SK046150018A06
	8 m	UD	BSB 35-50 Tuchel 7-pol.	Standard	7T4SK086150018A06
	4 m	UD	BSB 35-50 Tuchel 7-pol.	High Flex Leder	7T4SH046150018A06
	8 m	UD	BSB 35-50 Tuchel 7-pol.	High Flex Leder	7T4SH086150018A06
ABITIG® 200F	4 m	UD	BSB 35-50 Tuchel 7-pol.	Standard	7T4FK046150018A06
	8 m	UD	BSB 35-50 Tuchel 7-pol.	Standard	7T4FK086150018A06
	4 m	UD	BSB 35-50 Tuchel 7-pol.	High Flex Leder	7T4FH046150018A06
	8 m	UD	BSB 35-50 Tuchel 7-pol.	High Flex Leder	7T4FH086150018A06
ABITIG® 150	4 m	UD	BSB 35-50 Tuchel 7-pol.	Standard	7T6SK046150018A06
	8 m	UD	BSB 35-50 Tuchel 7-pol.	Standard	7T6SK086150018A06
	4 m	UD	BSB 35-50 Tuchel 7-pol.	High Flex Leder	7T6SH046150018A06
	8 m	UD	BSB 35-50 Tuchel 7-pol.	High Flex Leder	7T6SH086150018A06
ABITIG® 150F	4 m	UD	BSB 35-50 Tuchel 7-pol.	Standard	7T6FK046150018A06
	8 m	UD	BSB 35-50 Tuchel 7-pol.	Standard	7T6FK086150018A06
	4 m	UD	BSB 35-50 Tuchel 7-pol.	High Flex Leder	7T6FH046150018A06
	8 m	UD	BSB 35-50 Tuchel 7-pol.	High Flex Leder	7T6FH086150018A06

ABITIG®-Brennerpreisliste

passend für WIG-Stromquellen des Fabrikates „castolin“



Brennertyp	Länge	Schalterfunktion	maschinenseitiger Anschluss	Schlauchpaketausführung	Bestellnummer
ABITIG® 9	4 m	ED	MAG - ZA	Standard	7S1SK043013496A00
	8 m	ED	MAG - ZA	Standard	7S1SK083013496A00
	4 m	ED	MAG - ZA	High Flex Leder	7S1SH043013496A00
	8 m	ED	MAG - ZA	High Flex Leder	7S1SH083013496A00
ABITIG® 9F	4 m	ED	MAG - ZA	Standard	7S1FK043013496A00
	8 m	ED	MAG - ZA	Standard	7S1FK083013496A00
	4 m	ED	MAG - ZA	High Flex Leder	7S1FH043013496A00
	8 m	ED	MAG - ZA	High Flex Leder	7S1FH083013496A00
ABITIG® 17	4 m	ED	MAG - ZA	Standard	7S2SK043013496A00
	8 m	ED	MAG - ZA	Standard	7S2SK083013496A00
	4 m	ED	MAG - ZA	High Flex Leder	7S2SH043013496A00
	8 m	ED	MAG - ZA	High Flex Leder	7S2SH083013496A00
ABITIG® 17F	4 m	ED	MAG - ZA	Standard	7S2FK043013496A00
	8 m	ED	MAG - ZA	Standard	7S2FK083013496A00
	4 m	ED	MAG - ZA	High Flex Leder	7S2FH043013496A00
	8 m	ED	MAG - ZA	High Flex Leder	7S2FH083013496A00

Technische Änderungen vorbehalten • Verkaufspreise = unverbindliche Preisempfehlung - Angebot freibleibend • © Copyright

ABITIG®-Brennerpreisliste

passend für WIG-Stromquellen des Fabrikates „castolin“

Brennertyp	Länge	Schalterfunktion	maschinenseitiger Anschluss	Schlauchpaketausführung	Bestellnummer
ABITIG® 26	4 m	ED	MAG - ZA	Standard	7S3SK043013496A00
	8 m	ED	MAG - ZA	Standard	7S3SK083013496A00
	4 m	ED	MAG - ZA	High Flex Leder	7S3SH043013496A00
	8 m	ED	MAG - ZA	High Flex Leder	7S3SH083013496A00
ABITIG® 26F	4 m	ED	MAG - ZA	Standard	7S3FK043013496A00
	8 m	ED	MAG - ZA	Standard	7S3FK083013496A00
	4 m	ED	MAG - ZA	High Flex Leder	7S3FH043013496A00
	8 m	ED	MAG - ZA	High Flex Leder	7S3FH083013496A00
ABITIG® 24G	4 m	ED	MAG - ZA	Standard	7S8SK043013496A00
	8 m	ED	MAG - ZA	Standard	7S8SK083013496A00
	4 m	ED	MAG - ZA	High Flex Leder	7S8SH043013496A00
	8 m	ED	MAG - ZA	High Flex Leder	7S8SH083013496A00
ABITIG® 200	4 m	ED	MAG - ZA	Standard	7T4SK043013496A00
	8 m	ED	MAG - ZA	Standard	7T4SK083013496A00
	4 m	ED	MAG - ZA	High Flex Leder	7T4SH043013496A00
	8 m	ED	MAG - ZA	High Flex Leder	7T4SH083013496A00
ABITIG® 200F	4 m	ED	MAG - ZA	Standard	7T4FK043013496A00
	8 m	ED	MAG - ZA	Standard	7T4FK083013496A00
	4 m	ED	MAG - ZA	High Flex Leder	7T4FH043013496A00
	8 m	ED	MAG - ZA	High Flex Leder	7T4FH083013496A00
ABITIG® 150	4 m	ED	MAG - ZA	Standard	7T6SK043013496A00
	8 m	ED	MAG - ZA	Standard	7T6SK083013496A00
	4 m	ED	MAG - ZA	High Flex Leder	7T6SH043013496A00
	8 m	ED	MAG - ZA	High Flex Leder	7T6SH083013496A00
ABITIG® 150F	4 m	ED	MAG - ZA	Standard	7T6FK043013496A00
	8 m	ED	MAG - ZA	Standard	7T6FK083013496A00
	4 m	ED	MAG - ZA	High Flex Leder	7T6FH043013496A00
	8 m	ED	MAG - ZA	High Flex Leder	7T6FH083013496A00

ABITIG®-Brennerpreisliste

passend für WIG-Stromquellen des Fabrikates „castolin“



Brennertyp	Länge	Schalterfunktion	maschinenseitiger Anschluss	Schlauchpaketausführung	Bestellnummer
ABITIG® 18	4 m	DD	ZA - WZ-0 Tuchel 5-pol.	Standard	7S4SK043020302C12
	8 m	DD	ZA - WZ-0 Tuchel 5-pol.	Standard	7S4SK083020302C12
	4 m	DD	ZA - WZ-0 Tuchel 5-pol.	High Flex Leder	7S4SH043020302C12
	8 m	DD	ZA - WZ-0 Tuchel 5-pol.	High Flex Leder	7S4SH083020302C12

ABITIG® 18F	4 m	DD	ZA - WZ-0 Tuchel 5-pol.	Standard	7S4FK043020302C12
	8 m	DD	ZA - WZ-0 Tuchel 5-pol.	Standard	7S4FK083020302C12
	4 m	DD	ZA - WZ-0 Tuchel 5-pol.	High Flex Leder	7S4FH043020302C12
	8 m	DD	ZA - WZ-0 Tuchel 5-pol.	High Flex Leder	7S4FH083020302C12

ABITIG® 20	4 m	DD	ZA - WZ-0 Tuchel 5-pol.	Standard	7S5SK043020302C12
	8 m	DD	ZA - WZ-0 Tuchel 5-pol.	Standard	7S5SK083020302C12
	4 m	DD	ZA - WZ-0 Tuchel 5-pol.	High Flex Leder	7S5SH043020302C12
	8 m	DD	ZA - WZ-0 Tuchel 5-pol.	High Flex Leder	7S5SH083020302C12

ABITIG® 20F	4 m	DD	ZA - WZ-0 Tuchel 5-pol.	Standard	7S5FK043020302C12
	8 m	DD	ZA - WZ-0 Tuchel 5-pol.	Standard	7S5FK083020302C12
	4 m	DD	ZA - WZ-0 Tuchel 5-pol.	High Flex Leder	7S5FH043020302C12
	8 m	DD	ZA - WZ-0 Tuchel 5-pol.	High Flex Leder	7S5FH083020302C12

Technische Änderungen vorbehalten • Verkaufspreise = unverbindliche Preisempfehlung - Angebot freibleibend • © Copyright

ABITIG®-Brennerpreisliste

passend für WIG-Stromquellen des Fabrikates „castolin“

Brennertyp	Länge	Schalterfunktion	maschinenseitiger Anschluss	Schlauchpaketausführung	Bestellnummer
ABITIG® 12-1	4 m	DD	ZA - WZ-0 Tuchel 5-pol.	Standard	7S6SK043020302C12
	8 m	DD	ZA - WZ-0 Tuchel 5-pol.	Standard	7S6SK083020302C12
	4 m	DD	ZA - WZ-0 Tuchel 5-pol.	High Flex Leder	7S6SH043020302C12
	8 m	DD	ZA - WZ-0 Tuchel 5-pol.	High Flex Leder	7S6SH083020302C12
ABITIG® 18SC	4 m	DD	ZA - WZ-0 Tuchel 5-pol.	Standard	7S7SK043020302C12
	8 m	DD	ZA - WZ-0 Tuchel 5-pol.	Standard	7S7SK083020302C12
	4 m	DD	ZA - WZ-0 Tuchel 5-pol.	High Flex Leder	7S7SH043020302C12
	8 m	DD	ZA - WZ-0 Tuchel 5-pol.	High Flex Leder	7S7SH083020302C12
ABITIG® 24W	4 m	DD	ZA - WZ-0 Tuchel 5-pol.	Standard	7S9SK043020302C12
	8 m	DD	ZA - WZ-0 Tuchel 5-pol.	Standard	7S9SK083020302C12
	4 m	DD	ZA - WZ-0 Tuchel 5-pol.	High Flex Leder	7S9SH043020302C12
	8 m	DD	ZA - WZ-0 Tuchel 5-pol.	High Flex Leder	7S9SH083020302C12
ABITIG® 450W	4 m	DD	ZA - WZ-0 Tuchel 5-pol.	Standard	7T5SK043020302C12
	8 m	DD	ZA - WZ-0 Tuchel 5-pol.	Standard	7T5SK083020302C12
	4 m	DD	ZA - WZ-0 Tuchel 5-pol.	High Flex Leder	7T5SH043020302C12
	8 m	DD	ZA - WZ-0 Tuchel 5-pol.	High Flex Leder	7T5SH083020302C12
ABITIG® 260W	4 m	DD	ZA - WZ-0 Tuchel 5-pol.	Standard	7T7SK043020302C12
	8 m	DD	ZA - WZ-0 Tuchel 5-pol.	Standard	7T7SK083020302C12
	4 m	DD	ZA - WZ-0 Tuchel 5-pol.	High Flex Leder	7T7SH043020302C12
	8 m	DD	ZA - WZ-0 Tuchel 5-pol.	High Flex Leder	7T7SH083020302C12
ABITIG® 450W SC	4 m	DD	ZA - WZ-0 Tuchel 5-pol.	Standard	
	8 m	DD	ZA - WZ-0 Tuchel 5-pol.	Standard	
	4 m	DD	ZA - WZ-0 Tuchel 5-pol.	High Flex Leder	7T8SH043020302C12
	8 m	DD	ZA - WZ-0 Tuchel 5-pol.	High Flex Leder	7T8SH083020302C12

ABITIG®-Brennerpreisliste

passend für WIG-Stromquellen des Fabrikates „castolin“



Brennertyp	Länge	Schalterfunktion	maschinenseitiger Anschluss	Schlauchpaketausführung	Bestellnummer
ABITIG® 18	4 m	DD	ZA - WZ-0 Tuchel 7-pol.	Standard	7S4SK043020334A12
	8 m	DD	ZA - WZ-0 Tuchel 7-pol.	Standard	7S4SK083020334A12
	4 m	DD	ZA - WZ-0 Tuchel 7-pol.	High Flex Leder	7S4SH043020334A12
	8 m	DD	ZA - WZ-0 Tuchel 7-pol.	High Flex Leder	7S4SH083020334A12
ABITIG® 18F	4 m	DD	ZA - WZ-0 Tuchel 7-pol.	Standard	7S4FK043020334A12
	8 m	DD	ZA - WZ-0 Tuchel 7-pol.	Standard	7S4FK083020334A12
	4 m	DD	ZA - WZ-0 Tuchel 7-pol.	High Flex Leder	7S4FH043020334A12
	8 m	DD	ZA - WZ-0 Tuchel 7-pol.	High Flex Leder	7S4FH083020334A12
ABITIG® 20	4 m	DD	ZA - WZ-0 Tuchel 7-pol.	Standard	7S5SK043020334A12
	8 m	DD	ZA - WZ-0 Tuchel 7-pol.	Standard	7S5SK083020334A12
	4 m	DD	ZA - WZ-0 Tuchel 7-pol.	High Flex Leder	7S5SH043020334A12
	8 m	DD	ZA - WZ-0 Tuchel 7-pol.	High Flex Leder	7S5SH083020334A12
ABITIG® 20F	4 m	DD	ZA - WZ-0 Tuchel 7-pol.	Standard	7S5FK043020334A12
	8 m	DD	ZA - WZ-0 Tuchel 7-pol.	Standard	7S5FK083020334A12
	4 m	DD	ZA - WZ-0 Tuchel 7-pol.	High Flex Leder	7S5FH043020334A12
	8 m	DD	ZA - WZ-0 Tuchel 7-pol.	High Flex Leder	7S5FH083020334A12

Technische Änderungen vorbehalten • Verkaufspreise = unverbindliche Preisempfehlung - Angebot freibleibend • © Copyright

ABITIG®-Brennerpreisliste

passend für WIG-Stromquellen des Fabrikates „castolin“

Brennertyp	Länge	Schalterfunktion	maschinenseitiger Anschluss	Schlauchpaketausführung	Bestellnummer
ABITIG® 12-1	4 m	DD	ZA - WZ-0 Tuchel 7-pol.	Standard	7S6SK043020334A12
	8 m	DD	ZA - WZ-0 Tuchel 7-pol.	Standard	7S6SK083020334A12
	4 m	DD	ZA - WZ-0 Tuchel 7-pol.	High Flex Leder	7S6SH043020334A12
	8 m	DD	ZA - WZ-0 Tuchel 7-pol.	High Flex Leder	7S6SH083020334A12
ABITIG® 18SC	4 m	DD	ZA - WZ-0 Tuchel 7-pol.	Standard	7S7SK043020334A12
	8 m	DD	ZA - WZ-0 Tuchel 7-pol.	Standard	7S7SK083020334A12
	4 m	DD	ZA - WZ-0 Tuchel 7-pol.	High Flex Leder	7S7SH043020334A12
	8 m	DD	ZA - WZ-0 Tuchel 7-pol.	High Flex Leder	7S7SH083020334A12
ABITIG® 24W	4 m	DD	ZA - WZ-0 Tuchel 7-pol.	Standard	7S9SK043020334A12
	8 m	DD	ZA - WZ-0 Tuchel 7-pol.	Standard	7S9SK083020334A12
	4 m	DD	ZA - WZ-0 Tuchel 7-pol.	High Flex Leder	7S9SH043020334A12
	8 m	DD	ZA - WZ-0 Tuchel 7-pol.	High Flex Leder	7S9SH083020334A12
ABITIG® 450W	4 m	DD	ZA - WZ-0 Tuchel 7-pol.	Standard	7T5SK043020334A12
	8 m	DD	ZA - WZ-0 Tuchel 7-pol.	Standard	7T5SK083020334A12
	4 m	DD	ZA - WZ-0 Tuchel 7-pol.	High Flex Leder	7T5SH043020334A12
	8 m	DD	ZA - WZ-0 Tuchel 7-pol.	High Flex Leder	7T5SH083020334A12
ABITIG® 260W	4 m	DD	ZA - WZ-0 Tuchel 7-pol.	Standard	7T7SK043020334A12
	8 m	DD	ZA - WZ-0 Tuchel 7-pol.	Standard	7T7SK083020334A12
	4 m	DD	ZA - WZ-0 Tuchel 7-pol.	High Flex Leder	7T7SH043020334A12
	8 m	DD	ZA - WZ-0 Tuchel 7-pol.	High Flex Leder	7T7SH083020334A12
ABITIG® 450W SC	4 m	DD	ZA - WZ-0 Tuchel 7-pol.	Standard	
	8 m	DD	ZA - WZ-0 Tuchel 7-pol.	Standard	
	4 m	DD	ZA - WZ-0 Tuchel 7-pol.	High Flex Leder	7T8SH043020334A12
	8 m	DD	ZA - WZ-0 Tuchel 7-pol.	High Flex Leder	7T8SH083020334A12

ABITIG®-Brennerpreisliste

passend für WIG-Stromquellen des Fabrikates „castolin“ Up/Down

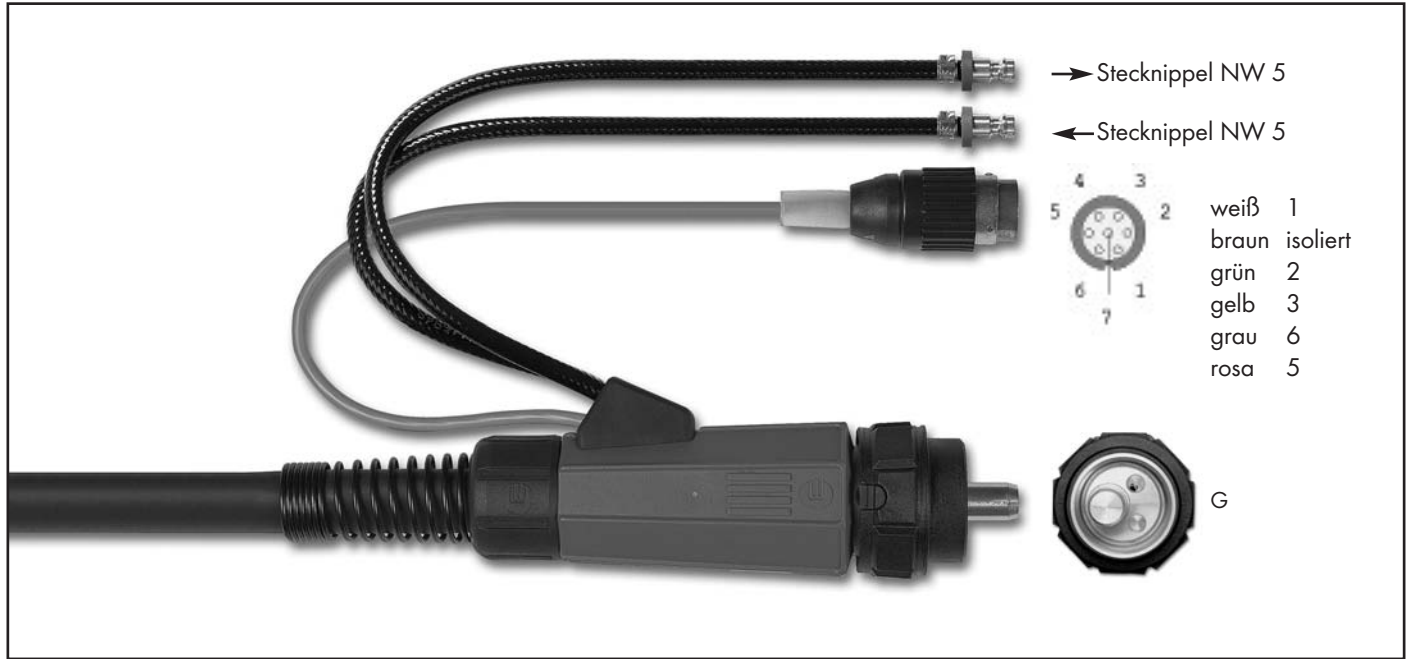

Brennertyp	Länge	Schalterfunktion	maschinenseitiger Anschluss	Schlauchpaketausführung	Bestellnummer
ABITIG® 18	4 m	UD	ZA - WZ-0 Tuchel 7-pol.	Standard	7S4SK046150318A12
	8 m	UD	ZA - WZ-0 Tuchel 7-pol.	Standard	7S4SK086150318A12
	4 m	UD	ZA - WZ-0 Tuchel 7-pol.	High Flex Leder	7S4SH046150318A12
	8 m	UD	ZA - WZ-0 Tuchel 7-pol.	High Flex Leder	7S4SH086150318A12
ABITIG® 18F	4 m	UD	ZA - WZ-0 Tuchel 7-pol.	Standard	7S4FK046150318A12
	8 m	UD	ZA - WZ-0 Tuchel 7-pol.	Standard	7S4FK086150318A12
	4 m	UD	ZA - WZ-0 Tuchel 7-pol.	High Flex Leder	7S4FH046150318A12
	8 m	UD	ZA - WZ-0 Tuchel 7-pol.	High Flex Leder	7S4FH086150318A12
ABITIG® 20	4 m	UD	ZA - WZ-0 Tuchel 7-pol.	Standard	7S5SK046150318A12
	8 m	UD	ZA - WZ-0 Tuchel 7-pol.	Standard	7S5SK086150318A12
	4 m	UD	ZA - WZ-0 Tuchel 7-pol.	High Flex Leder	7S5SH046150318A12
	8 m	UD	ZA - WZ-0 Tuchel 7-pol.	High Flex Leder	7S5SH086150318A12
ABITIG® 20F	4 m	UD	ZA - WZ-0 Tuchel 7-pol.	Standard	7S5FK046150318A12
	8 m	UD	ZA - WZ-0 Tuchel 7-pol.	Standard	7S5FK086150318A12
	4 m	UD	ZA - WZ-0 Tuchel 7-pol.	High Flex Leder	7S5FH046150318A12
	8 m	UD	ZA - WZ-0 Tuchel 7-pol.	High Flex Leder	7S5FH086150318A12

Technische Änderungen vorbehalten • Verkaufspreise = unverbindliche Preisempfehlung - Angebot freibleibend • © Copyright

ABITIG®-Brennerpreisliste

passend für WIG-Stromquellen des Fabrikates „castolin“ Up/Down

Brennertyp	Länge	Schalterfunktion	maschinenseitiger Anschluss	Schlauchpaketausführung	Bestellnummer
ABITIG® 12-1	4 m	UD	ZA - WZ-0 Tuchel 7-pol.	Standard	7S6SK046150318A12
	8 m	UD	ZA - WZ-0 Tuchel 7-pol.	Standard	7S6SK086150318A12
	4 m	UD	ZA - WZ-0 Tuchel 7-pol.	High Flex Leder	7S6SH046150318A12
	8 m	UD	ZA - WZ-0 Tuchel 7-pol.	High Flex Leder	7S6SH086150318A12
ABITIG® 18SC	4 m	UD	ZA - WZ-0 Tuchel 7-pol.	Standard	7S7SK046150318A12
	8 m	UD	ZA - WZ-0 Tuchel 7-pol.	Standard	7S7SK086150318A12
	4 m	UD	ZA - WZ-0 Tuchel 7-pol.	High Flex Leder	7S7SH046150318A12
	8 m	UD	ZA - WZ-0 Tuchel 7-pol.	High Flex Leder	7S7SH086150318A12
ABITIG® 24W	4 m	UD	ZA - WZ-0 Tuchel 7-pol.	Standard	7S9SK046150318A12
	8 m	UD	ZA - WZ-0 Tuchel 7-pol.	Standard	7S9SK086150318A12
	4 m	UD	ZA - WZ-0 Tuchel 7-pol.	High Flex Leder	7S9SH046150318A12
	8 m	UD	ZA - WZ-0 Tuchel 7-pol.	High Flex Leder	7S9SH086150318A12
ABITIG® 450W	4 m	UD	ZA - WZ-0 Tuchel 7-pol.	Standard	7T5SK046150318A12
	8 m	UD	ZA - WZ-0 Tuchel 7-pol.	Standard	7T5SK086150318A12
	4 m	UD	ZA - WZ-0 Tuchel 7-pol.	High Flex Leder	7T5SH046150318A12
	8 m	UD	ZA - WZ-0 Tuchel 7-pol.	High Flex Leder	7T5SH086150318A12
ABITIG® 260W	4 m	UD	ZA - WZ-0 Tuchel 7-pol.	Standard	7T7SK046150318A12
	8 m	UD	ZA - WZ-0 Tuchel 7-pol.	Standard	7T7SK086150318A12
	4 m	UD	ZA - WZ-0 Tuchel 7-pol.	High Flex Leder	7T7SH046150318A12
	8 m	UD	ZA - WZ-0 Tuchel 7-pol.	High Flex Leder	7T7SH086150318A12
ABITIG® 450W SC	4 m	UD	ZA - WZ-0 Tuchel 7-pol.	Standard	
	8 m	UD	ZA - WZ-0 Tuchel 7-pol.	Standard	
	4 m	UD	ZA - WZ-0 Tuchel 7-pol.	High Flex Leder	7T8SH046150318A12
	8 m	UD	ZA - WZ-0 Tuchel 7-pol.	High Flex Leder	7T8SH086150318A12

ABITIG®-Brennerpreisliste

passend für WIG-Stromquellen des Fabrikates „castolin“

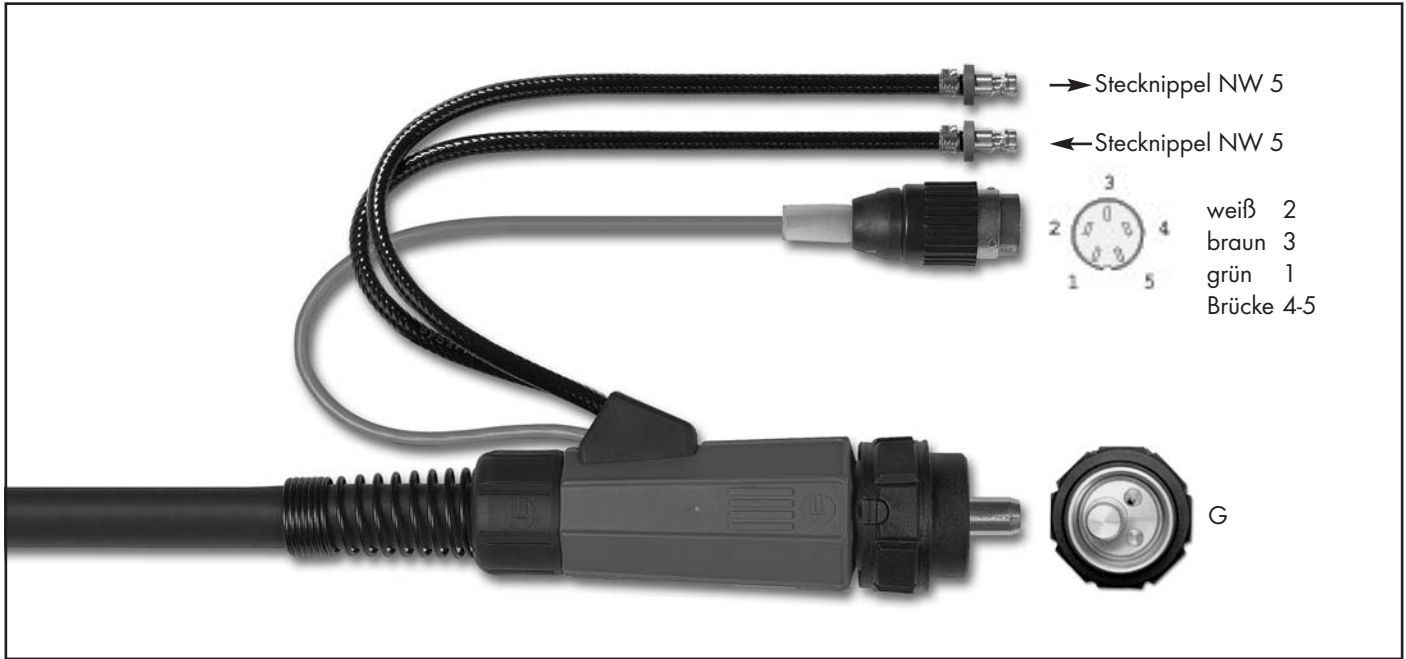

Brennertyp	Länge	Schalterfunktion	maschinenseitiger Anschluss	Schlauchpaketausführung	Bestellnummer
ABITIG® 18	4 m	ED	ZA - WZ-0 Tuchel 5-pol.	Standard	7S4SK043010302A12
	8 m	ED	ZA - WZ-0 Tuchel 5-pol.	Standard	7S4SK083010302A12
	4 m	ED	ZA - WZ-0 Tuchel 5-pol.	High Flex Leder	7S4SH043010302A12
	8 m	ED	ZA - WZ-0 Tuchel 5-pol.	High Flex Leder	7S4SH083010302A12
ABITIG® 18F	4 m	ED	ZA - WZ-0 Tuchel 5-pol.	Standard	7S4FK043010302A12
	8 m	ED	ZA - WZ-0 Tuchel 5-pol.	Standard	7S4FK083010302A12
	4 m	ED	ZA - WZ-0 Tuchel 5-pol.	High Flex Leder	7S4FH043010302A12
	8 m	ED	ZA - WZ-0 Tuchel 5-pol.	High Flex Leder	7S4FH083010302A12
ABITIG® 20	4 m	ED	ZA - WZ-0 Tuchel 5-pol.	Standard	7S5SK043010302A12
	8 m	ED	ZA - WZ-0 Tuchel 5-pol.	Standard	7S5SK083010302A12
	4 m	ED	ZA - WZ-0 Tuchel 5-pol.	High Flex Leder	7S5SH043010302A12
	8 m	ED	ZA - WZ-0 Tuchel 5-pol.	High Flex Leder	7S5SH083010302A12
ABITIG® 20F	4 m	ED	ZA - WZ-0 Tuchel 5-pol.	Standard	7S5FK043010302A12
	8 m	ED	ZA - WZ-0 Tuchel 5-pol.	Standard	7S5FK083010302A12
	4 m	ED	ZA - WZ-0 Tuchel 5-pol.	High Flex Leder	7S5FH043010302A12
	8 m	ED	ZA - WZ-0 Tuchel 5-pol.	High Flex Leder	7S5FH083010302A12

Technische Änderungen vorbehalten • Verkaufspreise = unverbindliche Preisempfehlung - Angebot freibleibend • © Copyright

ABITIG®-Brennerpreisliste

passend für WIG-Stromquellen des Fabrikates „castolin“

Brennertyp	Länge	Schalterfunktion	maschinenseitiger Anschluss	Schlauchpaketausführung	Bestellnummer
ABITIG® 12-1	4 m	ED	ZA - WZ-0 Tuchel 5-pol.	Standard	7S6SK043010302A12
	8 m	ED	ZA - WZ-0 Tuchel 5-pol.	Standard	7S6SK083010302A12
	4 m	ED	ZA - WZ-0 Tuchel 5-pol.	High Flex Leder	7S6SH043010302A12
	8 m	ED	ZA - WZ-0 Tuchel 5-pol.	High Flex Leder	7S6SH083010302A12
ABITIG® 18SC	4 m	ED	ZA - WZ-0 Tuchel 5-pol.	Standard	7S7SK043010302A12
	8 m	ED	ZA - WZ-0 Tuchel 5-pol.	Standard	7S7SK083010302A12
	4 m	ED	ZA - WZ-0 Tuchel 5-pol.	High Flex Leder	7S7SH043010302A12
	8 m	ED	ZA - WZ-0 Tuchel 5-pol.	High Flex Leder	7S7SH083010302A12
ABITIG® 24W	4 m	ED	ZA - WZ-0 Tuchel 5-pol.	Standard	7S9SK043010302A12
	8 m	ED	ZA - WZ-0 Tuchel 5-pol.	Standard	7S9SK083010302A12
	4 m	ED	ZA - WZ-0 Tuchel 5-pol.	High Flex Leder	7S9SH043010302A12
	8 m	ED	ZA - WZ-0 Tuchel 5-pol.	High Flex Leder	7S9SH083010302A12
ABITIG® 450W	4 m	ED	ZA - WZ-0 Tuchel 5-pol.	Standard	7T5SK043010302A12
	8 m	ED	ZA - WZ-0 Tuchel 5-pol.	Standard	7T5SK083010302A12
	4 m	ED	ZA - WZ-0 Tuchel 5-pol.	High Flex Leder	7T5SH043010302A12
	8 m	ED	ZA - WZ-0 Tuchel 5-pol.	High Flex Leder	7T5SH083010302A12
ABITIG® 260W	4 m	ED	ZA - WZ-0 Tuchel 5-pol.	Standard	7T7SK043010302A12
	8 m	ED	ZA - WZ-0 Tuchel 5-pol.	Standard	7T7SK083010302A12
	4 m	ED	ZA - WZ-0 Tuchel 5-pol.	High Flex Leder	7T7SH043010302A12
	8 m	ED	ZA - WZ-0 Tuchel 5-pol.	High Flex Leder	7T7SH083010302A12
ABITIG® 450W SC	4 m	ED	ZA - WZ-0 Tuchel 5-pol.	Standard	
	8 m	ED	ZA - WZ-0 Tuchel 5-pol.	Standard	
	4 m	ED	ZA - WZ-0 Tuchel 5-pol.	High Flex Leder	7T8SH043010302A12
	8 m	ED	ZA - WZ-0 Tuchel 5-pol.	High Flex Leder	7T8SH083010302A12

ABITIG®-Brennerpreisliste

passend für WIG-Stromquellen des Fabrikates „castolin“ Up/Down

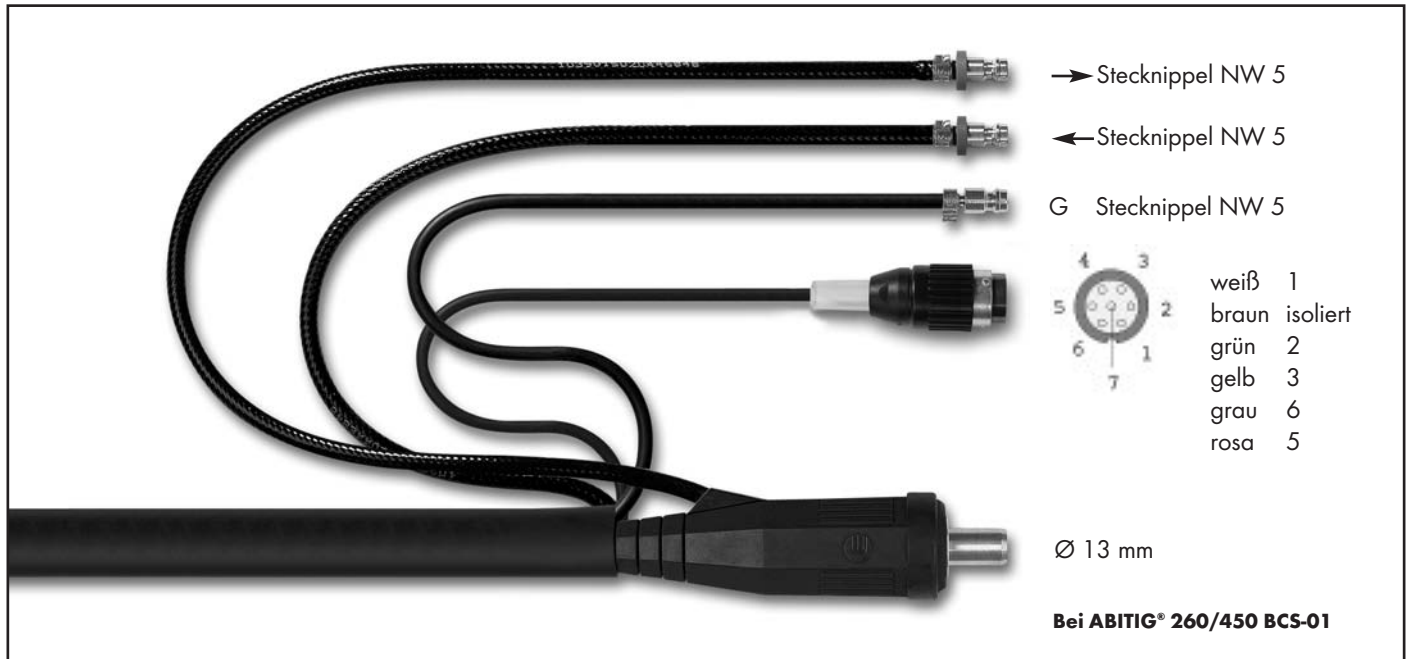

Brennertyp	Länge	Schalterfunktion	maschinenseitiger Anschluss	Schlauchpaketausführung	Bestellnummer
ABITIG® 18	4 m	UD	BSB 35-50 Tuchel 7-pol.	Standard	7S4SK046150018A20
	8 m	UD	BSB 35-50 Tuchel 7-pol.	Standard	7S4SK086150018A20
	4 m	UD	BSB 35-50 Tuchel 7-pol.	High Flex Leder	7S4SH046150018A20
	8 m	UD	BSB 35-50 Tuchel 7-pol.	High Flex Leder	7S4SH086150018A20
ABITIG® 18F	4 m	UD	BSB 35-50 Tuchel 7-pol.	Standard	7S4FK046150018A20
	8 m	UD	BSB 35-50 Tuchel 7-pol.	Standard	7S4FK086150018A20
	4 m	UD	BSB 35-50 Tuchel 7-pol.	High Flex Leder	7S4FH046150018A20
	8 m	UD	BSB 35-50 Tuchel 7-pol.	High Flex Leder	7S4FH086150018A20
ABITIG® 20	4 m	UD	BSB 35-50 Tuchel 7-pol.	Standard	7S5SK046150018A20
	8 m	UD	BSB 35-50 Tuchel 7-pol.	Standard	7S5SK086150018A20
	4 m	UD	BSB 35-50 Tuchel 7-pol.	High Flex Leder	7S5SH046150018A20
	8 m	UD	BSB 35-50 Tuchel 7-pol.	High Flex Leder	7S5SH086150018A20
ABITIG® 20F	4 m	UD	BSB 35-50 Tuchel 7-pol.	Standard	7S5FK046150018A20
	8 m	UD	BSB 35-50 Tuchel 7-pol.	Standard	7S5FK086150018A20
	4 m	UD	BSB 35-50 Tuchel 7-pol.	High Flex Leder	7S5FH046150018A20
	8 m	UD	BSB 35-50 Tuchel 7-pol.	High Flex Leder	7S5FH086150018A20

Technische Änderungen vorbehalten • Verkaufspreise = unverbindliche Preisempfehlung - Angebot freibleibend • © Copyright

ABITIG®-Brennerpreisliste

passend für WIG-Stromquellen des Fabrikates „castolin“ Up/Down

Brennertyp	Länge	Schalterfunktion	maschinenseitiger Anschluss	Schlauchpaketausführung	Bestellnummer
ABITIG® 12-1	4 m	UD	BSB 35-50 Tuchel 7-pol.	Standard	7S6SK046150018A20
	8 m	UD	BSB 35-50 Tuchel 7-pol.	Standard	7S6SK086150018A20
	4 m	UD	BSB 35-50 Tuchel 7-pol.	High Flex Leder	7S6SH046150018A20
	8 m	UD	BSB 35-50 Tuchel 7-pol.	High Flex Leder	7S6SH086150018A20

ABITIG® 18SC	4 m	UD	BSB 35-50 Tuchel 7-pol.	Standard	7S7SK046150018A20
	8 m	UD	BSB 35-50 Tuchel 7-pol.	Standard	7S7SK086150018A20
	4 m	UD	BSB 35-50 Tuchel 7-pol.	High Flex Leder	7S7SH046150018A20
	8 m	UD	BSB 35-50 Tuchel 7-pol.	High Flex Leder	7S7SH086150018A20

ABITIG® 24W	4 m	UD	BSB 35-50 Tuchel 7-pol.	Standard	7S9SK046150018A20
	8 m	UD	BSB 35-50 Tuchel 7-pol.	Standard	7S9SK086150018A20
	4 m	UD	BSB 35-50 Tuchel 7-pol.	High Flex Leder	7S9SH046150018A20
	8 m	UD	BSB 35-50 Tuchel 7-pol.	High Flex Leder	7S9SH086150018A20

ABITIG® 450W	4 m	UD	BSB 35-50 Tuchel 7-pol.	Standard	7T5SK046150118A20
	8 m	UD	BSB 35-50 Tuchel 7-pol.	Standard	7T5SK086150118A20
	4 m	UD	BSB 35-50 Tuchel 7-pol.	High Flex Leder	7T5SH046150118A20
	8 m	UD	BSB 35-50 Tuchel 7-pol.	High Flex Leder	7T5SH086150118A20

ABITIG® 260W	4 m	UD	BSB 35-50 Tuchel 7-pol.	Standard	7T7SK046150118A20
	8 m	UD	BSB 35-50 Tuchel 7-pol.	Standard	7T7SK086150118A20
	4 m	UD	BSB 35-50 Tuchel 7-pol.	High Flex Leder	7T7SH046150118A20
	8 m	UD	BSB 35-50 Tuchel 7-pol.	High Flex Leder	7T7SH086150118A20

ABITIG® 450W SC	4 m	UD	BSB 35-50 Tuchel 7-pol.	Standard	
	8 m	UD	BSB 35-50 Tuchel 7-pol.	Standard	
	4 m	UD	BSB 35-50 Tuchel 7-pol.	High Flex Leder	7T8SH046150118A20
	8 m	UD	BSB 35-50 Tuchel 7-pol.	High Flex Leder	7T8SH086150118A20

ABITIG®-Brennerpreisliste

passend für WIG-Stromquellen des Fabrikates „cebor“

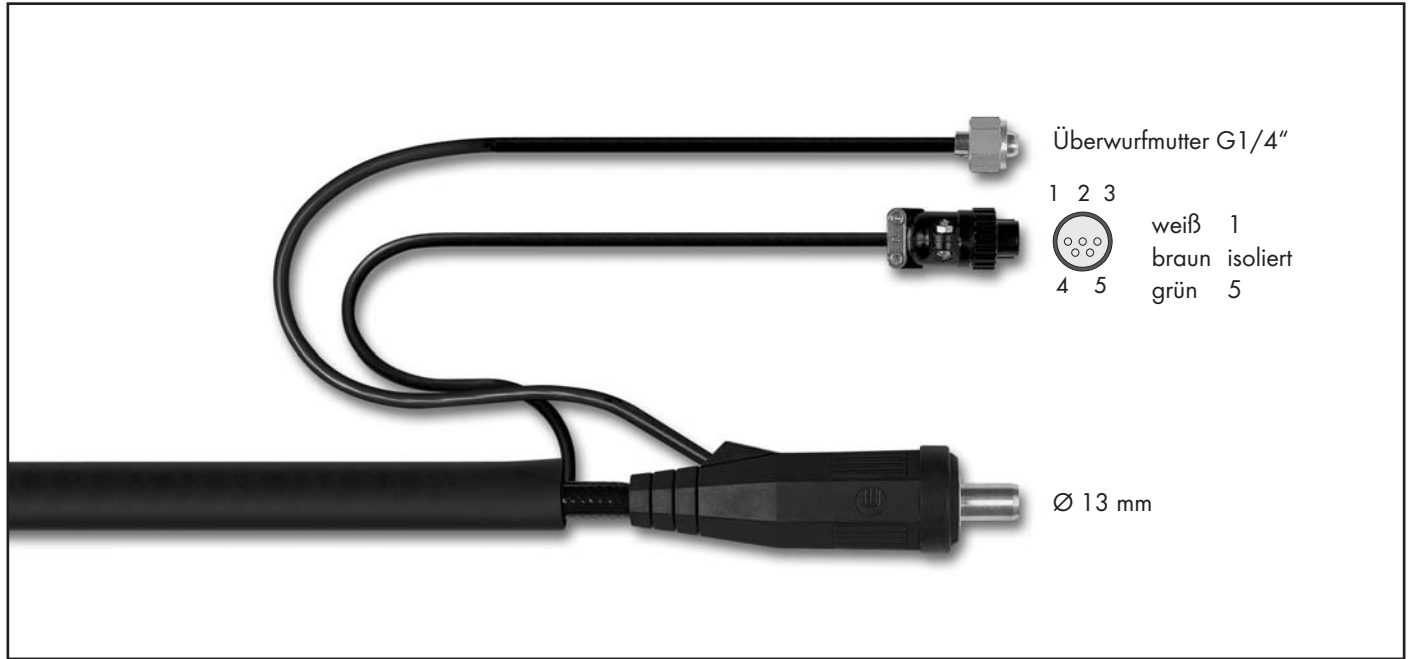

Brennertyp	Länge	Schalterfunktion	maschinenseitiger Anschluss	Schlauchpaketausführung	Bestellnummer
ABITIG® 9	4 m	ED	BSB 35-50 DDK-Stecker 5-pol.	Standard	7S1SK043010043A01
	8 m	ED	BSB 35-50 DDK-Stecker 5-pol.	Standard	7S1SK083010043A01
	4 m	ED	BSB 35-50 DDK-Stecker 5-pol.	High Flex Leder	7S1SH043010043A01
	8 m	ED	BSB 35-50 DDK-Stecker 5-pol.	High Flex Leder	7S1SH083010043A01
ABITIG® 9F	4 m	ED	BSB 35-50 DDK-Stecker 5-pol.	Standard	7S1FK043010043A01
	8 m	ED	BSB 35-50 DDK-Stecker 5-pol.	Standard	7S1FK083010043A01
	4 m	ED	BSB 35-50 DDK-Stecker 5-pol.	High Flex Leder	7S1FH043010043A01
	8 m	ED	BSB 35-50 DDK-Stecker 5-pol.	High Flex Leder	7S1FH083010043A01
ABITIG® 17	4 m	ED	BSB 35-50 DDK-Stecker 5-pol.	Standard	7S2SK043010043A01
	8 m	ED	BSB 35-50 DDK-Stecker 5-pol.	Standard	7S2SK083010043A01
	4 m	ED	BSB 35-50 DDK-Stecker 5-pol.	High Flex Leder	7S2SH043010043A01
	8 m	ED	BSB 35-50 DDK-Stecker 5-pol.	High Flex Leder	7S2SH083010043A01
ABITIG® 17F	4 m	ED	BSB 35-50 DDK-Stecker 5-pol.	Standard	7S2FK043010043A01
	8 m	ED	BSB 35-50 DDK-Stecker 5-pol.	Standard	7S2FK083010043A01
	4 m	ED	BSB 35-50 DDK-Stecker 5-pol.	High Flex Leder	7S2FH043010043A01
	8 m	ED	BSB 35-50 DDK-Stecker 5-pol.	High Flex Leder	7S2FH083010043A01

Technische Änderungen vorbehalten • Verkaufspreise = unverbindliche Preisempfehlung - Angebot freibleibend • © Copyright

ABITIG®-Brennerpreisliste

passend für WIG-Stromquellen des Fabrikates „cebora“

Brennertyp	Länge	Schalterfunktion	maschinenseitiger Anschluss	Schlauchpaketausführung	Bestellnummer
ABITIG® 26	4 m	ED	BSB 35-50 DDK-Stecker 5-pol.	Standard	7S3SK043010043A01
	8 m	ED	BSB 35-50 DDK-Stecker 5-pol.	Standard	7S3SK083010043A01
	4 m	ED	BSB 35-50 DDK-Stecker 5-pol.	High Flex Leder	7S3SH043010043A01
	8 m	ED	BSB 35-50 DDK-Stecker 5-pol.	High Flex Leder	7S3SH083010043A01
ABITIG® 26F	4 m	ED	BSB 35-50 DDK-Stecker 5-pol.	Standard	7S3FK043010043A01
	8 m	ED	BSB 35-50 DDK-Stecker 5-pol.	Standard	7S3FK083010043A01
	4 m	ED	BSB 35-50 DDK-Stecker 5-pol.	High Flex Leder	7S3FH043010043A01
	8 m	ED	BSB 35-50 DDK-Stecker 5-pol.	High Flex Leder	7S3FH083010043A01
ABITIG® 24G	4 m	ED	BSB 35-50 DDK-Stecker 5-pol.	Standard	7S8SK043010043A01
	8 m	ED	BSB 35-50 DDK-Stecker 5-pol.	Standard	7S8SK083010043A01
	4 m	ED	BSB 35-50 DDK-Stecker 5-pol.	High Flex Leder	7S8SH043010043A01
	8 m	ED	BSB 35-50 DDK-Stecker 5-pol.	High Flex Leder	7S8SH083010043A01
ABITIG® 200	4 m	ED	BSB 35-50 DDK-Stecker 5-pol.	Standard	7T4SK043010043A01
	8 m	ED	BSB 35-50 DDK-Stecker 5-pol.	Standard	7T4SK083010043A01
	4 m	ED	BSB 35-50 DDK-Stecker 5-pol.	High Flex Leder	7T4SH043010043A01
	8 m	ED	BSB 35-50 DDK-Stecker 5-pol.	High Flex Leder	7T4SH083010043A01
ABITIG® 200F	4 m	ED	BSB 35-50 DDK-Stecker 5-pol.	Standard	7T4FK043010043A01
	8 m	ED	BSB 35-50 DDK-Stecker 5-pol.	Standard	7T4FK083010043A01
	4 m	ED	BSB 35-50 DDK-Stecker 5-pol.	High Flex Leder	7T4FH043010043A01
	8 m	ED	BSB 35-50 DDK-Stecker 5-pol.	High Flex Leder	7T4FH083010043A01
ABITIG® 150	4 m	ED	BSB 35-50 DDK-Stecker 5-pol.	Standard	7T6SK043010043A01
	8 m	ED	BSB 35-50 DDK-Stecker 5-pol.	Standard	7T6SK083010043A01
	4 m	ED	BSB 35-50 DDK-Stecker 5-pol.	High Flex Leder	7T6SH043010043A01
	8 m	ED	BSB 35-50 DDK-Stecker 5-pol.	High Flex Leder	7T6SH083010043A01
ABITIG® 150F	4 m	ED	BSB 35-50 DDK-Stecker 5-pol.	Standard	7T6FK043010043A01
	8 m	ED	BSB 35-50 DDK-Stecker 5-pol.	Standard	7T6FK083010043A01
	4 m	ED	BSB 35-50 DDK-Stecker 5-pol.	High Flex Leder	7T6FH043010043A01
	8 m	ED	BSB 35-50 DDK-Stecker 5-pol.	High Flex Leder	7T6FH083010043A01

ABITIG®-Brennerpreisliste

passend für WIG-Stromquellen des Fabrikates „ceborä“

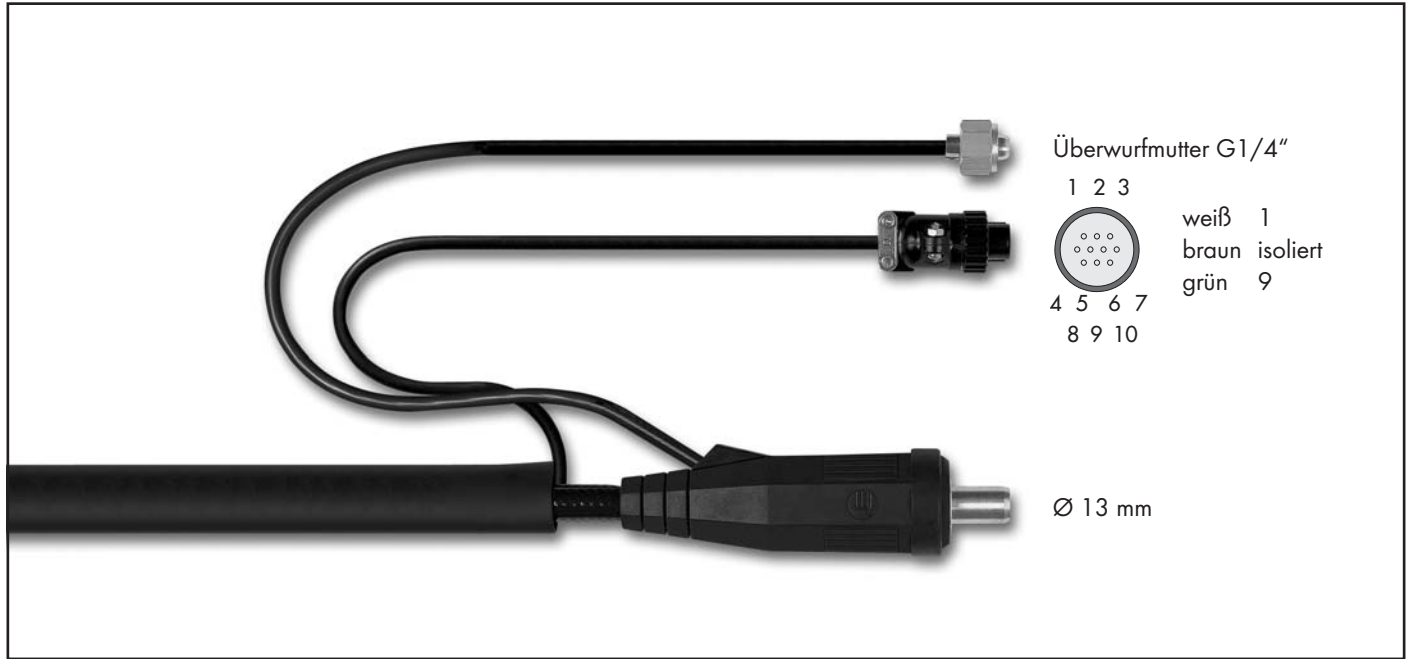

Brennertyp	Länge	Schalterfunktion	maschinenseitiger Anschluss	Schlauchpaketausführung	Bestellnummer
ABITIG® 9	4 m	ED	BSB 35-50 DDK-Stecker 10-pol.	Standard	7S1SK043010043C01
	8 m	ED	BSB 35-50 DDK-Stecker 10-pol.	Standard	7S1SK083010043C01
	4 m	ED	BSB 35-50 DDK-Stecker 10-pol.	High Flex Leder	7S1SH043010043C01
	8 m	ED	BSB 35-50 DDK-Stecker 10-pol.	High Flex Leder	7S1SH083010043C01
ABITIG® 9F	4 m	ED	BSB 35-50 DDK-Stecker 10-pol.	Standard	7S1FK043010043C01
	8 m	ED	BSB 35-50 DDK-Stecker 10-pol.	Standard	7S1FK083010043C01
	4 m	ED	BSB 35-50 DDK-Stecker 10-pol.	High Flex Leder	7S1FH043010043C01
	8 m	ED	BSB 35-50 DDK-Stecker 10-pol.	High Flex Leder	7S1FH083010043C01
ABITIG® 17	4 m	ED	BSB 35-50 DDK-Stecker 10-pol.	Standard	7S2SK043010043C01
	8 m	ED	BSB 35-50 DDK-Stecker 10-pol.	Standard	7S2SK083010043C01
	4 m	ED	BSB 35-50 DDK-Stecker 10-pol.	High Flex Leder	7S2SH043010043C01
	8 m	ED	BSB 35-50 DDK-Stecker 10-pol.	High Flex Leder	7S2SH083010043C01
ABITIG® 17F	4 m	ED	BSB 35-50 DDK-Stecker 10-pol.	Standard	7S2FK043010043C01
	8 m	ED	BSB 35-50 DDK-Stecker 10-pol.	Standard	7S2FK083010043C01
	4 m	ED	BSB 35-50 DDK-Stecker 10-pol.	High Flex Leder	7S2FH043010043C01
	8 m	ED	BSB 35-50 DDK-Stecker 10-pol.	High Flex Leder	7S2FH083010043C01

Technische Änderungen vorbehalten • Verkaufspreise = unverbindliche Preisempfehlung - Angebot freibleibend • © Copyright

ABITIG®-Brennerpreisliste

passend für WIG-Stromquellen des Fabrikates „cebora“

Brennertyp	Länge	Schalterfunktion	maschinenseitiger Anschluss	Schlauchpaketausführung	Bestellnummer
ABITIG® 26	4 m	ED	BSB 35-50 DDK-Stecker 10-pol.	Standard	7S3SK043010043C01
	8 m	ED	BSB 35-50 DDK-Stecker 10-pol.	Standard	7S3SK083010043C01
	4 m	ED	BSB 35-50 DDK-Stecker 10-pol.	High Flex Leder	7S3SH043010043C01
	8 m	ED	BSB 35-50 DDK-Stecker 10-pol.	High Flex Leder	7S3SH083010043C01
ABITIG® 26F	4 m	ED	BSB 35-50 DDK-Stecker 10-pol.	Standard	7S3FK043010043C01
	8 m	ED	BSB 35-50 DDK-Stecker 10-pol.	Standard	7S3FK083010043C01
	4 m	ED	BSB 35-50 DDK-Stecker 10-pol.	High Flex Leder	7S3FH043010043C01
	8 m	ED	BSB 35-50 DDK-Stecker 10-pol.	High Flex Leder	7S3FH083010043C01
ABITIG® 24G	4 m	ED	BSB 35-50 DDK-Stecker 10-pol.	Standard	7S8SK043010043C01
	8 m	ED	BSB 35-50 DDK-Stecker 10-pol.	Standard	7S8SK083010043C01
	4 m	ED	BSB 35-50 DDK-Stecker 10-pol.	High Flex Leder	7S8SH043010043C01
	8 m	ED	BSB 35-50 DDK-Stecker 10-pol.	High Flex Leder	7S8SH083010043C01
ABITIG® 200	4 m	ED	BSB 35-50 DDK-Stecker 10-pol.	Standard	7T4SK043010043C01
	8 m	ED	BSB 35-50 DDK-Stecker 10-pol.	Standard	7T4SK083010043C01
	4 m	ED	BSB 35-50 DDK-Stecker 10-pol.	High Flex Leder	7T4SH043010043C01
	8 m	ED	BSB 35-50 DDK-Stecker 10-pol.	High Flex Leder	7T4SH083010043C01
ABITIG® 200F	4 m	ED	BSB 35-50 DDK-Stecker 10-pol.	Standard	7T4FK043010043C01
	8 m	ED	BSB 35-50 DDK-Stecker 10-pol.	Standard	7T4FK083010043C01
	4 m	ED	BSB 35-50 DDK-Stecker 10-pol.	High Flex Leder	7T4FH043010043C01
	8 m	ED	BSB 35-50 DDK-Stecker 10-pol.	High Flex Leder	7T4FH083010043C01
ABITIG® 150	4 m	ED	BSB 35-50 DDK-Stecker 10-pol.	Standard	7T6SK043010043C01
	8 m	ED	BSB 35-50 DDK-Stecker 10-pol.	Standard	7T6SK083010043C01
	4 m	ED	BSB 35-50 DDK-Stecker 10-pol.	High Flex Leder	7T6SH043010043C01
	8 m	ED	BSB 35-50 DDK-Stecker 10-pol.	High Flex Leder	7T6SH083010043C01
ABITIG® 150F	4 m	ED	BSB 35-50 DDK-Stecker 10-pol.	Standard	7T6FK043010043C01
	8 m	ED	BSB 35-50 DDK-Stecker 10-pol.	Standard	7T6FK083010043C01
	4 m	ED	BSB 35-50 DDK-Stecker 10-pol.	High Flex Leder	7T6FH043010043C01
	8 m	ED	BSB 35-50 DDK-Stecker 10-pol.	High Flex Leder	7T6FH083010043C01

ABITIG®-Brennerpreisliste

passend für WIG-Stromquellen des Fabrikates „ceborä“ Up/Down

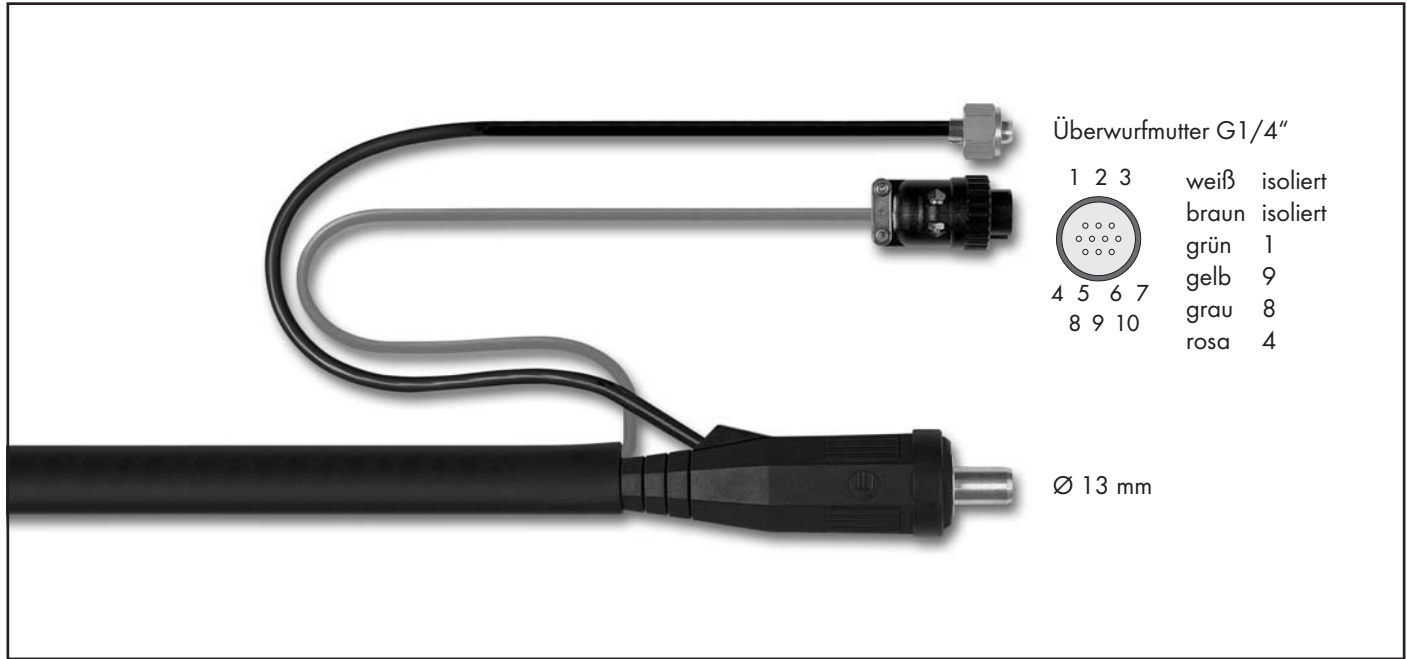

Brennertyp	Länge	Schalterfunktion	maschinenseitiger Anschluss	Schlauchpaketausführung	Bestellnummer
ABITIG® 9	4 m	UD	BSB 35-50 DDK-Stecker 10-pol.	Standard	7S1SK046150043D01
	8 m	UD	BSB 35-50 DDK-Stecker 10-pol.	Standard	7S1SK086150043D01
	4 m	UD	BSB 35-50 DDK-Stecker 10-pol.	High Flex Leder	7S1SH046150043D01
	8 m	UD	BSB 35-50 DDK-Stecker 10-pol.	High Flex Leder	7S1SH086150043D01

ABITIG® 9F	4 m	UD	BSB 35-50 DDK-Stecker 10-pol.	Standard	7S1FK046150043D01
	8 m	UD	BSB 35-50 DDK-Stecker 10-pol.	Standard	7S1FK086150043D01
	4 m	UD	BSB 35-50 DDK-Stecker 10-pol.	High Flex Leder	7S1FH046150043D01
	8 m	UD	BSB 35-50 DDK-Stecker 10-pol.	High Flex Leder	7S1FH086150043D01

ABITIG® 17	4 m	UD	BSB 35-50 DDK-Stecker 10-pol.	Standard	7S2SK046150043D01
	8 m	UD	BSB 35-50 DDK-Stecker 10-pol.	Standard	7S2SK086150043D01
	4 m	UD	BSB 35-50 DDK-Stecker 10-pol.	High Flex Leder	7S2SH046150043D01
	8 m	UD	BSB 35-50 DDK-Stecker 10-pol.	High Flex Leder	7S2SH086150043D01

ABITIG® 17F	4 m	UD	BSB 35-50 DDK-Stecker 10-pol.	Standard	7S2FK046150043D01
	8 m	UD	BSB 35-50 DDK-Stecker 10-pol.	Standard	7S2FK086150043D01
	4 m	UD	BSB 35-50 DDK-Stecker 10-pol.	High Flex Leder	7S2FH046150043D01
	8 m	UD	BSB 35-50 DDK-Stecker 10-pol.	High Flex Leder	7S2FH086150043D01

Technische Änderungen vorbehalten • Verkaufspreise = unverbindliche Preisempfehlung - Angebot freibleibend • © Copyright

ABITIG®-Brennerpreisliste

passend für WIG-Stromquellen des Fabrikates „cebora“ Up/Down

Brennertyp	Länge	Schalterfunktion	maschinenseitiger Anschluss	Schlauchpaketausführung	Bestellnummer
ABITIG® 26	4 m	UD	BSB 35-50 DDK-Stecker 10-pol.	Standard	7S3SK046150043D01
	8 m	UD	BSB 35-50 DDK-Stecker 10-pol.	Standard	7S3SK086150043D01
	4 m	UD	BSB 35-50 DDK-Stecker 10-pol.	High Flex Leder	7S3SH046150043D01
	8 m	UD	BSB 35-50 DDK-Stecker 10-pol.	High Flex Leder	7S3SH086150043D01
ABITIG® 26F	4 m	UD	BSB 35-50 DDK-Stecker 10-pol.	Standard	7S3FK046150043D01
	8 m	UD	BSB 35-50 DDK-Stecker 10-pol.	Standard	7S3FK086150043D01
	4 m	UD	BSB 35-50 DDK-Stecker 10-pol.	High Flex Leder	7S3FH046150043D01
	8 m	UD	BSB 35-50 DDK-Stecker 10-pol.	High Flex Leder	7S3FH086150043D01
ABITIG® 24G	4 m	UD	BSB 35-50 DDK-Stecker 10-pol.	Standard	7S8SK046150043D01
	8 m	UD	BSB 35-50 DDK-Stecker 10-pol.	Standard	7S8SK086150043D01
	4 m	UD	BSB 35-50 DDK-Stecker 10-pol.	High Flex Leder	7S8SH046150043D01
	8 m	UD	BSB 35-50 DDK-Stecker 10-pol.	High Flex Leder	7S8SH086150043D01
ABITIG® 200	4 m	UD	BSB 35-50 DDK-Stecker 10-pol.	Standard	7T4SK046150043D01
	8 m	UD	BSB 35-50 DDK-Stecker 10-pol.	Standard	7T4SK086150043D01
	4 m	UD	BSB 35-50 DDK-Stecker 10-pol.	High Flex Leder	7T4SH046150043D01
	8 m	UD	BSB 35-50 DDK-Stecker 10-pol.	High Flex Leder	7T4SH086150043D01
ABITIG® 200F	4 m	UD	BSB 35-50 DDK-Stecker 10-pol.	Standard	7T4FK046150043D01
	8 m	UD	BSB 35-50 DDK-Stecker 10-pol.	Standard	7T4FK086150043D01
	4 m	UD	BSB 35-50 DDK-Stecker 10-pol.	High Flex Leder	7T4FH046150043D01
	8 m	UD	BSB 35-50 DDK-Stecker 10-pol.	High Flex Leder	7T4FH086150043D01
ABITIG® 150	4 m	UD	BSB 35-50 DDK-Stecker 10-pol.	Standard	7T6SK046150043D01
	8 m	UD	BSB 35-50 DDK-Stecker 10-pol.	Standard	7T6SK086150043D01
	4 m	UD	BSB 35-50 DDK-Stecker 10-pol.	High Flex Leder	7T6SH046150043D01
	8 m	UD	BSB 35-50 DDK-Stecker 10-pol.	High Flex Leder	7T6SH086150043D01
ABITIG® 150F	4 m	UD	BSB 35-50 DDK-Stecker 10-pol.	Standard	7T6FK046150043D01
	8 m	UD	BSB 35-50 DDK-Stecker 10-pol.	Standard	7T6FK086150043D01
	4 m	UD	BSB 35-50 DDK-Stecker 10-pol.	High Flex Leder	7T6FH046150043D01
	8 m	UD	BSB 35-50 DDK-Stecker 10-pol.	High Flex Leder	7T6FH086150043D01

ABITIG®-Brennerpreisliste

passend für WIG-Stromquellen des Fabrikates „cebor“

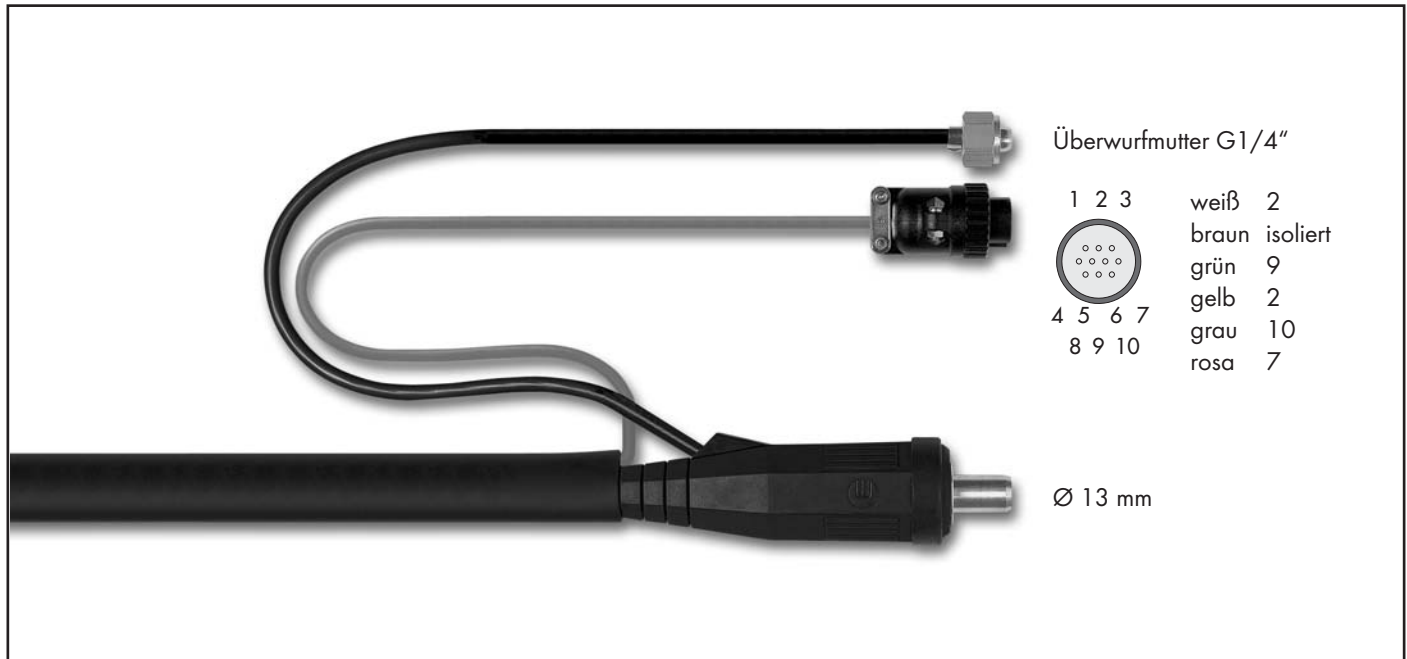

Brennertyp	Länge	Schalterfunktion	maschinenseitiger Anschluss	Schlauchpaketausführung	Bestellnummer
ABITIG® 9	4 m	EDP	BSB 35-50 DDK-Stecker 10-pol.	Standard	7S1SK046040043B01
	8 m	EDP	BSB 35-50 DDK-Stecker 10-pol.	Standard	7S1SK086040043B01
	4 m	EDP	BSB 35-50 DDK-Stecker 10-pol.	High Flex Leder	7S1SH046040043B01
	8 m	EDP	BSB 35-50 DDK-Stecker 10-pol.	High Flex Leder	7S1SH086040043B01

ABITIG® 9F	4 m	EDP	BSB 35-50 DDK-Stecker 10-pol.	Standard	7S1FK046040043B01
	8 m	EDP	BSB 35-50 DDK-Stecker 10-pol.	Standard	7S1FK086040043B01
	4 m	EDP	BSB 35-50 DDK-Stecker 10-pol.	High Flex Leder	7S1FH046040043B01
	8 m	EDP	BSB 35-50 DDK-Stecker 10-pol.	High Flex Leder	7S1FH086040043B01

ABITIG® 17	4 m	EDP	BSB 35-50 DDK-Stecker 10-pol.	Standard	7S2SK046040043B01
	8 m	EDP	BSB 35-50 DDK-Stecker 10-pol.	Standard	7S2SK086040043B01
	4 m	EDP	BSB 35-50 DDK-Stecker 10-pol.	High Flex Leder	7S2SH046040043B01
	8 m	EDP	BSB 35-50 DDK-Stecker 10-pol.	High Flex Leder	7S2SH086040043B01

ABITIG® 17F	4 m	EDP	BSB 35-50 DDK-Stecker 10-pol.	Standard	7S2FK046040043B01
	8 m	EDP	BSB 35-50 DDK-Stecker 10-pol.	Standard	7S2FK086040043B01
	4 m	EDP	BSB 35-50 DDK-Stecker 10-pol.	High Flex Leder	7S2FH046040043B01
	8 m	EDP	BSB 35-50 DDK-Stecker 10-pol.	High Flex Leder	7S2FH086040043B01

Technische Änderungen vorbehalten • Verkaufspreise = unverbindliche Preisempfehlung - Angebot freibleibend • © Copyright

ABITIG®-Brennerpreisliste

passend für WIG-Stromquellen des Fabrikates „cebora“

Brennertyp	Länge	Schalterfunktion	maschinenseitiger Anschluss	Schlauchpaketausführung	Bestellnummer
ABITIG® 26	4 m	EDP	BSB 35-50 DDK-Stecker 10-pol.	Standard	7S3SK046040043B01
	8 m	EDP	BSB 35-50 DDK-Stecker 10-pol.	Standard	7S3SK086040043B01
	4 m	EDP	BSB 35-50 DDK-Stecker 10-pol.	High Flex Leder	7S3SH046040043B01
	8 m	EDP	BSB 35-50 DDK-Stecker 10-pol.	High Flex Leder	7S3SH086040043B01
ABITIG® 26F	4 m	EDP	BSB 35-50 DDK-Stecker 10-pol.	Standard	7S3FK046040043B01
	8 m	EDP	BSB 35-50 DDK-Stecker 10-pol.	Standard	7S3FK086040043B01
	4 m	EDP	BSB 35-50 DDK-Stecker 10-pol.	High Flex Leder	7S3FH046040043B01
	8 m	EDP	BSB 35-50 DDK-Stecker 10-pol.	High Flex Leder	7S3FH086040043B01
ABITIG® 24G	4 m	EDP	BSB 35-50 DDK-Stecker 10-pol.	Standard	7S8SK046040043B01
	8 m	EDP	BSB 35-50 DDK-Stecker 10-pol.	Standard	7S8SK086040043B01
	4 m	EDP	BSB 35-50 DDK-Stecker 10-pol.	High Flex Leder	7S8SH046040043B01
	8 m	EDP	BSB 35-50 DDK-Stecker 10-pol.	High Flex Leder	7S8SH086040043B01
ABITIG® 200	4 m	EDP	BSB 35-50 DDK-Stecker 10-pol.	Standard	7T4SK046040043B01
	8 m	EDP	BSB 35-50 DDK-Stecker 10-pol.	Standard	7T4SK086040043B01
	4 m	EDP	BSB 35-50 DDK-Stecker 10-pol.	High Flex Leder	7T4SH046040043B01
	8 m	EDP	BSB 35-50 DDK-Stecker 10-pol.	High Flex Leder	7T4SH086040043B01
ABITIG® 200F	4 m	EDP	BSB 35-50 DDK-Stecker 10-pol.	Standard	7T4FK046040043B01
	8 m	EDP	BSB 35-50 DDK-Stecker 10-pol.	Standard	7T4FK086040043B01
	4 m	EDP	BSB 35-50 DDK-Stecker 10-pol.	High Flex Leder	7T4FH046040043B01
	8 m	EDP	BSB 35-50 DDK-Stecker 10-pol.	High Flex Leder	7T4FH086040043B01
ABITIG® 150	4 m	EDP	BSB 35-50 DDK-Stecker 10-pol.	Standard	7T6SK046040043B01
	8 m	EDP	BSB 35-50 DDK-Stecker 10-pol.	Standard	7T6SK086040043B01
	4 m	EDP	BSB 35-50 DDK-Stecker 10-pol.	High Flex Leder	7T6SH046040043B01
	8 m	EDP	BSB 35-50 DDK-Stecker 10-pol.	High Flex Leder	7T6SH086040043B01
ABITIG® 150F	4 m	EDP	BSB 35-50 DDK-Stecker 10-pol.	Standard	7T6FK046040043B01
	8 m	EDP	BSB 35-50 DDK-Stecker 10-pol.	Standard	7T6FK086040043B01
	4 m	EDP	BSB 35-50 DDK-Stecker 10-pol.	High Flex Leder	7T6FH046040043B01
	8 m	EDP	BSB 35-50 DDK-Stecker 10-pol.	High Flex Leder	7T6FH086040043B01

ABITIG®-Brennerpreisliste

passend für WIG-Stromquellen des Fabrikates „ceborä“

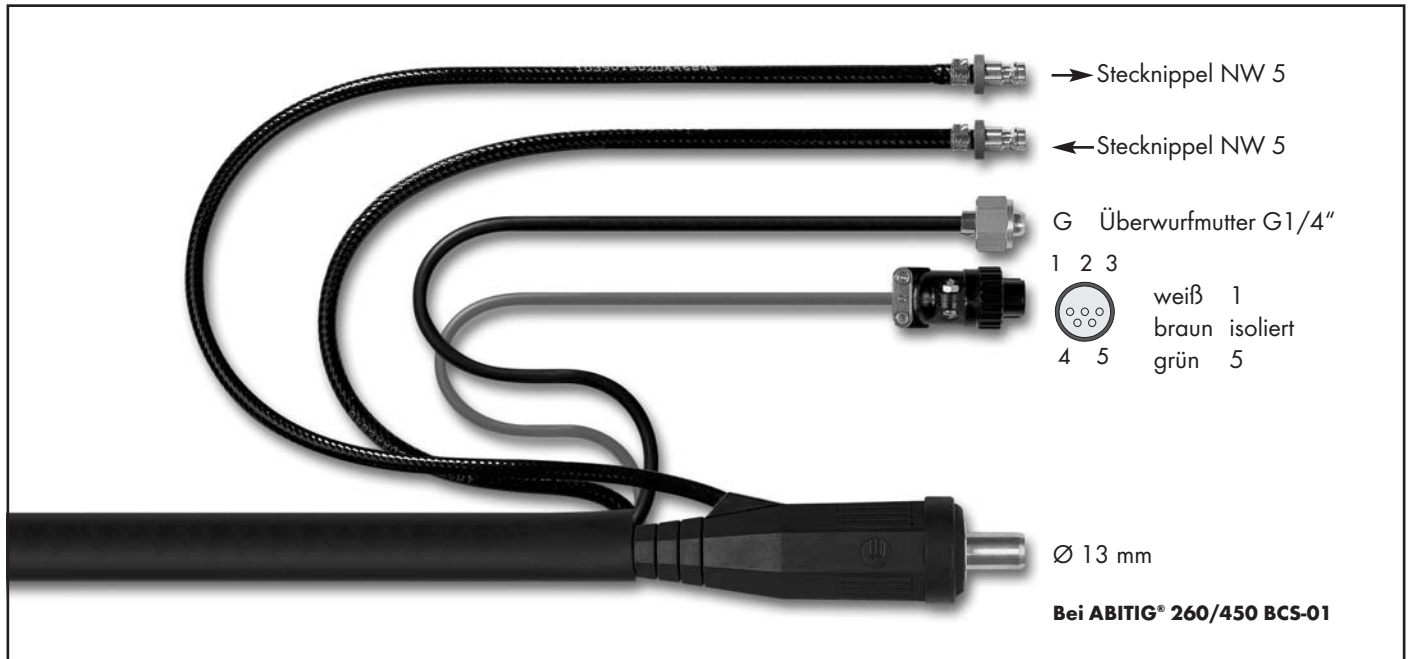

Brennertyp	Länge	Schalterfunktion	maschinenseitiger Anschluss	Schlauchpaketausführung	Bestellnummer
ABITIG® 18	4 m	ED	BSB 35-50 DDK-Stecker 5-pol.	Standard	7S4SK043010043A11
	8 m	ED	BSB 35-50 DDK-Stecker 5-pol.	Standard	7S4SK083010043A11
	4 m	ED	BSB 35-50 DDK-Stecker 5-pol.	High Flex Leder	7S4SH043010043A11
	8 m	ED	BSB 35-50 DDK-Stecker 5-pol.	High Flex Leder	7S4SH083010043A11
ABITIG® 18F	4 m	ED	BSB 35-50 DDK-Stecker 5-pol.	Standard	7S4FK043010043A11
	8 m	ED	BSB 35-50 DDK-Stecker 5-pol.	Standard	7S4FK083010043A11
	4 m	ED	BSB 35-50 DDK-Stecker 5-pol.	High Flex Leder	7S4FH043010043A11
	8 m	ED	BSB 35-50 DDK-Stecker 5-pol.	High Flex Leder	7S4FH083010043A11
ABITIG® 20	4 m	ED	BSB 35-50 DDK-Stecker 5-pol.	Standard	7S5SK043010043A11
	8 m	ED	BSB 35-50 DDK-Stecker 5-pol.	Standard	7S5SK083010043A11
	4 m	ED	BSB 35-50 DDK-Stecker 5-pol.	High Flex Leder	7S5SH043010043A11
	8 m	ED	BSB 35-50 DDK-Stecker 5-pol.	High Flex Leder	7S5SH083010043A11
ABITIG® 20F	4 m	ED	BSB 35-50 DDK-Stecker 5-pol.	Standard	7S5FK043010043A11
	8 m	ED	BSB 35-50 DDK-Stecker 5-pol.	Standard	7S5FK083010043A11
	4 m	ED	BSB 35-50 DDK-Stecker 5-pol.	High Flex Leder	7S5FH043010043A11
	8 m	ED	BSB 35-50 DDK-Stecker 5-pol.	High Flex Leder	7S5FH083010043A11

Technische Änderungen vorbehalten • Verkaufspreise = unverbindliche Preisempfehlung - Angebot freibleibend • © Copyright

ABITIG®-Brennerpreisliste

passend für WIG-Stromquellen des Fabrikates „cebora“

Brennertyp	Länge	Schalterfunktion	maschinenseitiger Anschluss	Schlauchpaketausführung	Bestellnummer
ABITIG® 12-1	4 m	ED	BSB 35-50 DDK-Stecker 5-pol.	Standard	7S6SK043010043A11
	8 m	ED	BSB 35-50 DDK-Stecker 5-pol.	Standard	7S6SK083010043A11
	4 m	ED	BSB 35-50 DDK-Stecker 5-pol.	High Flex Leder	7S6SH043010043A11
	8 m	ED	BSB 35-50 DDK-Stecker 5-pol.	High Flex Leder	7S6SH083010043A11
ABITIG® 18SC	4 m	ED	BSB 35-50 DDK-Stecker 5-pol.	Standard	7S7SK043010043A11
	8 m	ED	BSB 35-50 DDK-Stecker 5-pol.	Standard	7S7SK083010043A11
	4 m	ED	BSB 35-50 DDK-Stecker 5-pol.	High Flex Leder	7S7SH043010043A11
	8 m	ED	BSB 35-50 DDK-Stecker 5-pol.	High Flex Leder	7S7SH083010043A11
ABITIG® 24W	4 m	ED	BSB 35-50 DDK-Stecker 5-pol.	Standard	7S9SK043010043A11
	8 m	ED	BSB 35-50 DDK-Stecker 5-pol.	Standard	7S9SK083010043A11
	4 m	ED	BSB 35-50 DDK-Stecker 5-pol.	High Flex Leder	7S9SH043010043A11
	8 m	ED	BSB 35-50 DDK-Stecker 5-pol.	High Flex Leder	7S9SH083010043A11
ABITIG® 450W	4 m	ED	BSB 35-50 DDK-Stecker 5-pol.	Standard	7T5SK043010143A11
	8 m	ED	BSB 35-50 DDK-Stecker 5-pol.	Standard	7T5SK083010143A11
	4 m	ED	BSB 35-50 DDK-Stecker 5-pol.	High Flex Leder	7T5SH043010143A11
	8 m	ED	BSB 35-50 DDK-Stecker 5-pol.	High Flex Leder	7T5SH083010143A11
ABITIG® 260W	4 m	ED	BSB 35-50 DDK-Stecker 5-pol.	Standard	7T7SK043010143A11
	8 m	ED	BSB 35-50 DDK-Stecker 5-pol.	Standard	7T7SK083010143A11
	4 m	ED	BSB 35-50 DDK-Stecker 5-pol.	High Flex Leder	7T7SH043010143A11
	8 m	ED	BSB 35-50 DDK-Stecker 5-pol.	High Flex Leder	7T7SH083010143A11
ABITIG® 450W SC	4 m	ED	BSB 35-50 DDK-Stecker 5-pol.	Standard	
	8 m	ED	BSB 35-50 DDK-Stecker 5-pol.	Standard	
	4 m	ED	BSB 35-50 DDK-Stecker 5-pol.	High Flex Leder	7T8SH043010143A11
	8 m	ED	BSB 35-50 DDK-Stecker 5-pol.	High Flex Leder	7T8SH083010143A11

ABITIG®-Brennerpreisliste

passend für WIG-Stromquellen des Fabrikates „ceborä“

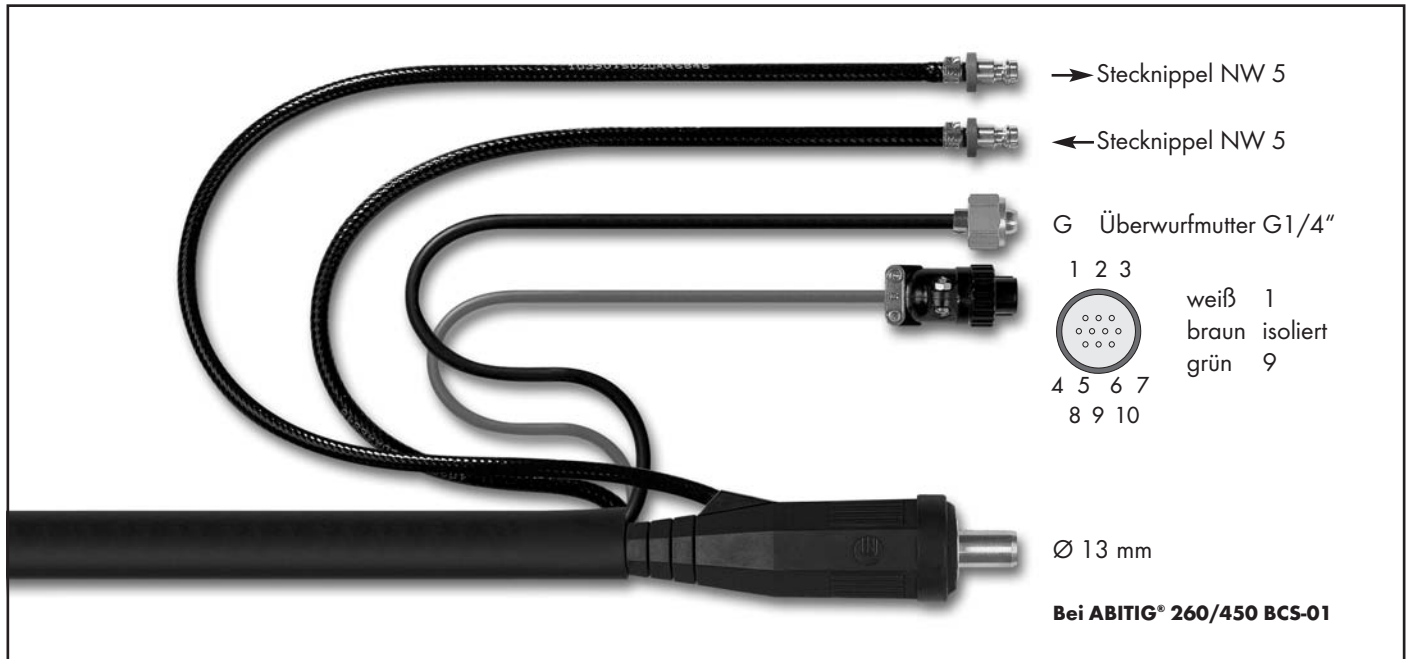

Brennertyp	Länge	Schalterfunktion	maschinenseitiger Anschluss	Schlauchpaketausführung	Bestellnummer
ABITIG® 18	4 m	ED	BSB 35-50 DDK-Stecker 10-pol.	Standard	7S4SK043010043C11
	8 m	ED	BSB 35-50 DDK-Stecker 10-pol.	Standard	7S4SK083010043C11
	4 m	ED	BSB 35-50 DDK-Stecker 10-pol.	High Flex Leder	7S4SH043010043C11
	8 m	ED	BSB 35-50 DDK-Stecker 10-pol.	High Flex Leder	7S4SH083010043C11
ABITIG® 18F	4 m	ED	BSB 35-50 DDK-Stecker 10-pol.	Standard	7S4FK043010043C11
	8 m	ED	BSB 35-50 DDK-Stecker 10-pol.	Standard	7S4FK083010043C11
	4 m	ED	BSB 35-50 DDK-Stecker 10-pol.	High Flex Leder	7S4FH043010043C11
	8 m	ED	BSB 35-50 DDK-Stecker 10-pol.	High Flex Leder	7S4FH083010043C11
ABITIG® 20	4 m	ED	BSB 35-50 DDK-Stecker 10-pol.	Standard	7S5SK043010043C11
	8 m	ED	BSB 35-50 DDK-Stecker 10-pol.	Standard	7S5SK083010043C11
	4 m	ED	BSB 35-50 DDK-Stecker 10-pol.	High Flex Leder	7S5SH043010043C11
	8 m	ED	BSB 35-50 DDK-Stecker 10-pol.	High Flex Leder	7S5SH083010043C11
ABITIG® 20F	4 m	ED	BSB 35-50 DDK-Stecker 10-pol.	Standard	7S5FK043010043C11
	8 m	ED	BSB 35-50 DDK-Stecker 10-pol.	Standard	7S5FK083010043C11
	4 m	ED	BSB 35-50 DDK-Stecker 10-pol.	High Flex Leder	7S5FH043010043C11
	8 m	ED	BSB 35-50 DDK-Stecker 10-pol.	High Flex Leder	7S5FH083010043C11

Technische Änderungen vorbehalten • Verkaufspreise = unverbindliche Preisempfehlung - Angebot freibleibend • © Copyright

ABITIG®-Brennerpreisliste

passend für WIG-Stromquellen des Fabrikates „cebora“

Brennertyp	Länge	Schalterfunktion	maschinenseitiger Anschluss	Schlauchpaketausführung	Bestellnummer
ABITIG® 12-1	4 m	ED	BSB 35-50 DDK-Stecker 10-pol.	Standard	7S6SK043010043C11
	8 m	ED	BSB 35-50 DDK-Stecker 10-pol.	Standard	7S6SK083010043C11
	4 m	ED	BSB 35-50 DDK-Stecker 10-pol.	High Flex Leder	7S6SH043010043C11
	8 m	ED	BSB 35-50 DDK-Stecker 10-pol.	High Flex Leder	7S6SH083010043C11

ABITIG® 18SC	4 m	ED	BSB 35-50 DDK-Stecker 10-pol.	Standard	7S7SK043010043C11
	8 m	ED	BSB 35-50 DDK-Stecker 10-pol.	Standard	7S7SK083010043C11
	4 m	ED	BSB 35-50 DDK-Stecker 10-pol.	High Flex Leder	7S7SH043010043C11
	8 m	ED	BSB 35-50 DDK-Stecker 10-pol.	High Flex Leder	7S7SH083010043C11

ABITIG® 24W	4 m	ED	BSB 35-50 DDK-Stecker 10-pol.	Standard	7S9SK043010043C11
	8 m	ED	BSB 35-50 DDK-Stecker 10-pol.	Standard	7S9SK083010043C11
	4 m	ED	BSB 35-50 DDK-Stecker 10-pol.	High Flex Leder	7S9SH043010043C11
	8 m	ED	BSB 35-50 DDK-Stecker 10-pol.	High Flex Leder	7S9SH083010043C11

ABITIG® 450W	4 m	ED	BSB 35-50 DDK-Stecker 10-pol.	Standard	7T5SK043010143C11
	8 m	ED	BSB 35-50 DDK-Stecker 10-pol.	Standard	7T5SK083010143C11
	4 m	ED	BSB 35-50 DDK-Stecker 10-pol.	High Flex Leder	7T5SH043010143C11
	8 m	ED	BSB 35-50 DDK-Stecker 10-pol.	High Flex Leder	7T5SH083010143C11

ABITIG® 260W	4 m	ED	BSB 35-50 DDK-Stecker 10-pol.	Standard	7T7SK043010143C11
	8 m	ED	BSB 35-50 DDK-Stecker 10-pol.	Standard	7T7SK083010143C11
	4 m	ED	BSB 35-50 DDK-Stecker 10-pol.	High Flex Leder	7T7SH043010143C11
	8 m	ED	BSB 35-50 DDK-Stecker 10-pol.	High Flex Leder	7T7SH083010143C11

ABITIG® 450W SC	4 m	ED	BSB 35-50 DDK-Stecker 10-pol.	Standard	
	8 m	ED	BSB 35-50 DDK-Stecker 10-pol.	Standard	
	4 m	ED	BSB 35-50 DDK-Stecker 10-pol.	High Flex Leder	7T8SH043010143C11
	8 m	ED	BSB 35-50 DDK-Stecker 10-pol.	High Flex Leder	7T8SH083010143C11

ABITIG®-Brennerpreisliste

passend für WIG-Stromquellen des Fabrikates „cebora“ Up/Down

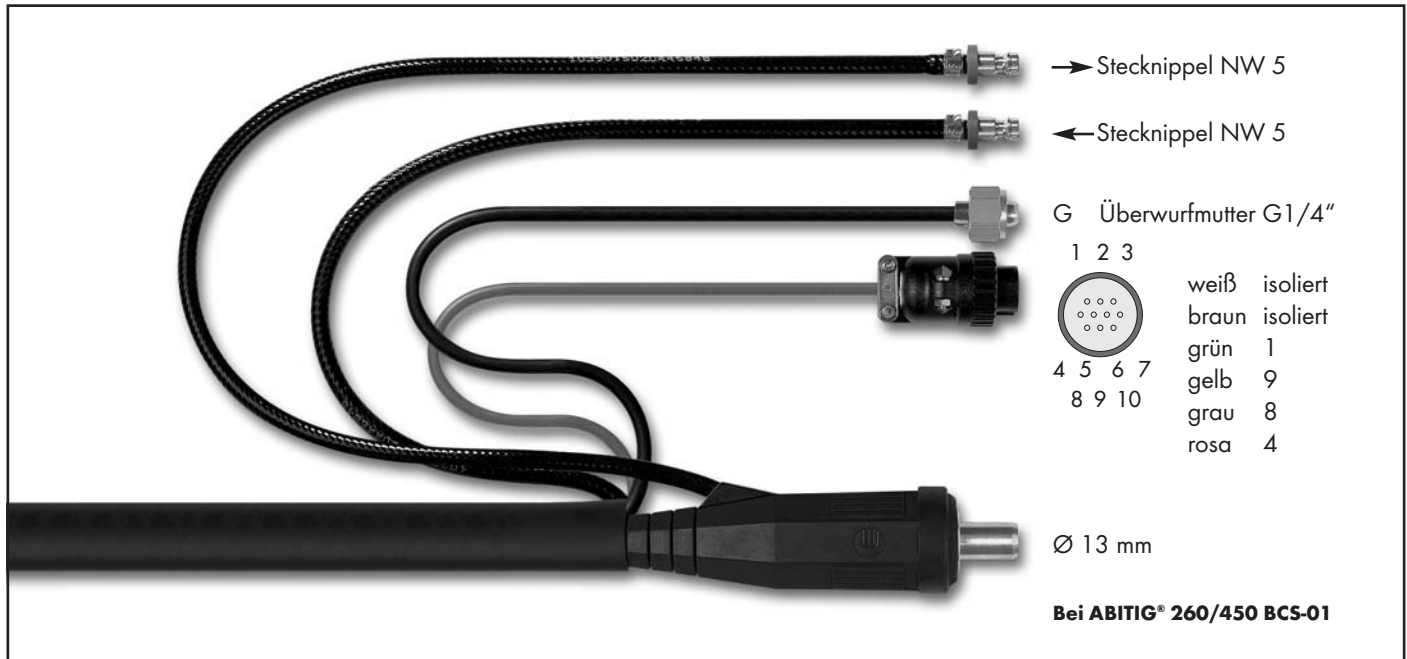

Brennertyp	Länge	Schalterfunktion	maschinenseitiger Anschluss	Schlauchpaketausführung	Bestellnummer
ABITIG® 18	4 m	UD	BSB 35-50 DDK-Stecker 10-pol.	Standard	7S4SK046150043D11
	8 m	UD	BSB 35-50 DDK-Stecker 10-pol.	Standard	7S4SK086150043D11
	4 m	UD	BSB 35-50 DDK-Stecker 10-pol.	High Flex Leder	7S4SH046150043D11
	8 m	UD	BSB 35-50 DDK-Stecker 10-pol.	High Flex Leder	7S4SH086150043D11
ABITIG® 18F	4 m	UD	BSB 35-50 DDK-Stecker 10-pol.	Standard	7S4FK046150043D11
	8 m	UD	BSB 35-50 DDK-Stecker 10-pol.	Standard	7S4FK086150043D11
	4 m	UD	BSB 35-50 DDK-Stecker 10-pol.	High Flex Leder	7S4FH046150043D11
	8 m	UD	BSB 35-50 DDK-Stecker 10-pol.	High Flex Leder	7S4FH086150043D11
ABITIG® 20	4 m	UD	BSB 35-50 DDK-Stecker 10-pol.	Standard	7S5SK046150043D11
	8 m	UD	BSB 35-50 DDK-Stecker 10-pol.	Standard	7S5SK086150043D11
	4 m	UD	BSB 35-50 DDK-Stecker 10-pol.	High Flex Leder	7S5SH046150043D11
	8 m	UD	BSB 35-50 DDK-Stecker 10-pol.	High Flex Leder	7S5SH086150043D11
ABITIG® 20F	4 m	UD	BSB 35-50 DDK-Stecker 10-pol.	Standard	7S5FK046150043D11
	8 m	UD	BSB 35-50 DDK-Stecker 10-pol.	Standard	7S5FK086150043D11
	4 m	UD	BSB 35-50 DDK-Stecker 10-pol.	High Flex Leder	7S5FH046150043D11
	8 m	UD	BSB 35-50 DDK-Stecker 10-pol.	High Flex Leder	7S5FH086150043D11

Technische Änderungen vorbehalten • Verkaufspreise = unverbindliche Preisempfehlung - Angebot freibleibend • © Copyright

ABITIG®-Brennerpreisliste

passend für WIG-Stromquellen des Fabrikates „cebora“ Up/Down

Brennertyp	Länge	Schalterfunktion	maschinenseitiger Anschluss	Schlauchpaketausführung	Bestellnummer
ABITIG® 12-1	4 m	UD	BSB 35-50 DDK-Stecker 10-pol.	Standard	7S6SK046150043D11
	8 m	UD	BSB 35-50 DDK-Stecker 10-pol.	Standard	7S6SK086150043D11
	4 m	UD	BSB 35-50 DDK-Stecker 10-pol.	High Flex Leder	7S6SH046150043D11
	8 m	UD	BSB 35-50 DDK-Stecker 10-pol.	High Flex Leder	7S6SH086150043D11

ABITIG® 18SC	4 m	UD	BSB 35-50 DDK-Stecker 10-pol.	Standard	7S7SK046150043D11
	8 m	UD	BSB 35-50 DDK-Stecker 10-pol.	Standard	7S7SK086150043D11
	4 m	UD	BSB 35-50 DDK-Stecker 10-pol.	High Flex Leder	7S7SH046150043D11
	8 m	UD	BSB 35-50 DDK-Stecker 10-pol.	High Flex Leder	7S7SH086150043D11

ABITIG® 24W	4 m	UD	BSB 35-50 DDK-Stecker 10-pol.	Standard	7S9SK046150043D11
	8 m	UD	BSB 35-50 DDK-Stecker 10-pol.	Standard	7S9SK086150043D11
	4 m	UD	BSB 35-50 DDK-Stecker 10-pol.	High Flex Leder	7S9SH046150043D11
	8 m	UD	BSB 35-50 DDK-Stecker 10-pol.	High Flex Leder	7S9SH086150043D11

ABITIG® 450W	4 m	UD	BSB 35-50 DDK-Stecker 10-pol.	Standard	7T5SK046150143D11
	8 m	UD	BSB 35-50 DDK-Stecker 10-pol.	Standard	7T5SK086150143D11
	4 m	UD	BSB 35-50 DDK-Stecker 10-pol.	High Flex Leder	7T5SH046150143D11
	8 m	UD	BSB 35-50 DDK-Stecker 10-pol.	High Flex Leder	7T5SH086150143D11

ABITIG® 260W	4 m	UD	BSB 35-50 DDK-Stecker 10-pol.	Standard	7T7SK046150143D11
	8 m	UD	BSB 35-50 DDK-Stecker 10-pol.	Standard	7T7SK086150143D11
	4 m	UD	BSB 35-50 DDK-Stecker 10-pol.	High Flex Leder	7T7SH046150143D11
	8 m	UD	BSB 35-50 DDK-Stecker 10-pol.	High Flex Leder	7T7SH086150143D11

ABITIG® 450W SC	4 m	UD	BSB 35-50 DDK-Stecker 10-pol.	Standard	
	8 m	UD	BSB 35-50 DDK-Stecker 10-pol.	Standard	
	4 m	UD	BSB 35-50 DDK-Stecker 10-pol.	High Flex Leder	7T8SH046150143D11
	8 m	UD	BSB 35-50 DDK-Stecker 10-pol.	High Flex Leder	7T8SH086150143D11

ABITIG®-Brennerpreisliste

passend für WIG-Stromquellen des Fabrikates „cebora“

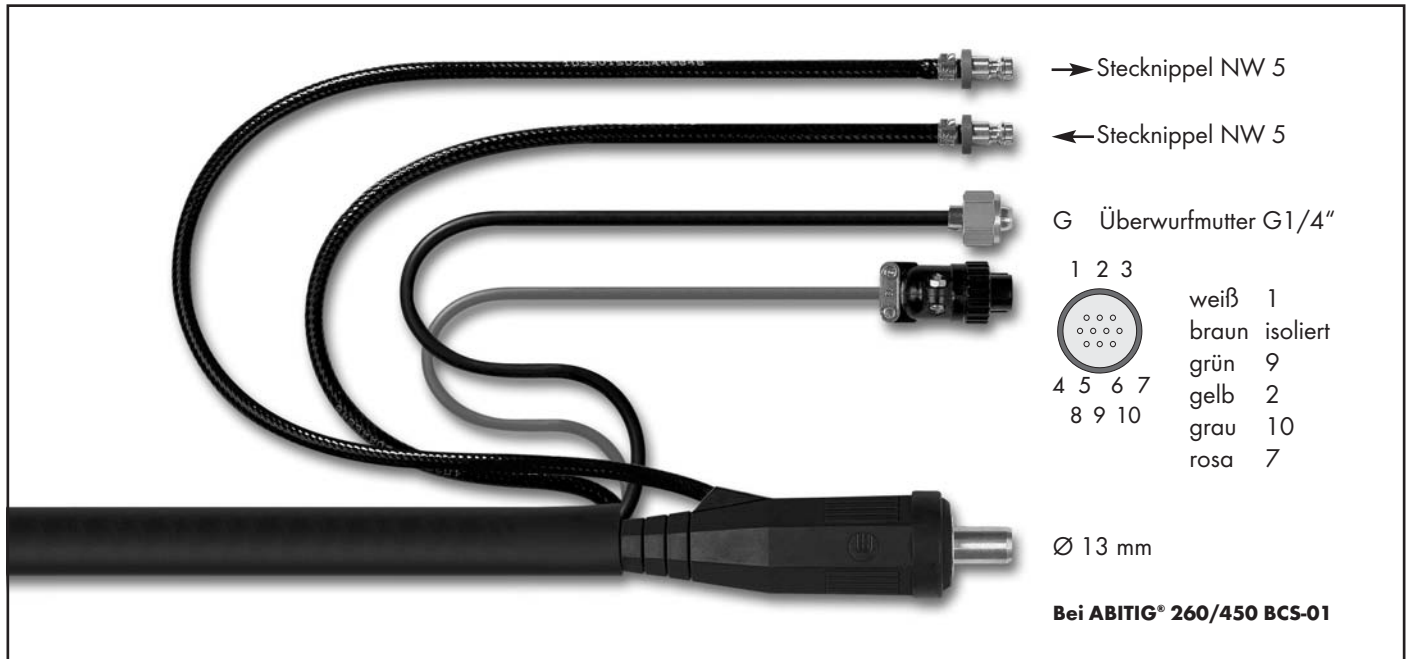

Brennertyp	Länge	Schalterfunktion	maschinenseitiger Anschluss	Schlauchpaketausführung	Bestellnummer
ABITIG® 18	4 m	EDP	BSB 35-50 DDK-Stecker 10-pol.	Standard	7S4SK046040043B11
	8 m	EDP	BSB 35-50 DDK-Stecker 10-pol.	Standard	7S4SK086040043B11
	4 m	EDP	BSB 35-50 DDK-Stecker 10-pol.	High Flex Leder	7S4SH046040043B11
	8 m	EDP	BSB 35-50 DDK-Stecker 10-pol.	High Flex Leder	7S4SH086040043B11
ABITIG® 18F	4 m	EDP	BSB 35-50 DDK-Stecker 10-pol.	Standard	7S4FK046040043B11
	8 m	EDP	BSB 35-50 DDK-Stecker 10-pol.	Standard	7S4FK086040043B11
	4 m	EDP	BSB 35-50 DDK-Stecker 10-pol.	High Flex Leder	7S4FH046040043B11
	8 m	EDP	BSB 35-50 DDK-Stecker 10-pol.	High Flex Leder	7S4FH086040043B11
ABITIG® 20	4 m	EDP	BSB 35-50 DDK-Stecker 10-pol.	Standard	7S5SK046040043B11
	8 m	EDP	BSB 35-50 DDK-Stecker 10-pol.	Standard	7S5SK086040043B11
	4 m	EDP	BSB 35-50 DDK-Stecker 10-pol.	High Flex Leder	7S5SH046040043B11
	8 m	EDP	BSB 35-50 DDK-Stecker 10-pol.	High Flex Leder	7S5SH086040043B11
ABITIG® 20F	4 m	EDP	BSB 35-50 DDK-Stecker 10-pol.	Standard	7S5FK046040043B11
	8 m	EDP	BSB 35-50 DDK-Stecker 10-pol.	Standard	7S5FK086040043B11
	4 m	EDP	BSB 35-50 DDK-Stecker 10-pol.	High Flex Leder	7S5FH046040043B11
	8 m	EDP	BSB 35-50 DDK-Stecker 10-pol.	High Flex Leder	7S5FH086040043B11

Technische Änderungen vorbehalten • Verkaufspreise = unverbindliche Preisempfehlung - Angebot freibleibend • © Copyright

ABITIG®-Brennerpreisliste

passend für WIG-Stromquellen des Fabrikates „cebora“

Brennertyp	Länge	Schalterfunktion	maschinenseitiger Anschluss	Schlauchpaketausführung	Bestellnummer
ABITIG® 12-1	4 m	EDP	BSB 35-50 DDK-Stecker 10-pol.	Standard	7S6SK046040043B11
	8 m	EDP	BSB 35-50 DDK-Stecker 10-pol.	Standard	7S6SK086040043B11
	4 m	EDP	BSB 35-50 DDK-Stecker 10-pol.	High Flex Leder	7S6SH046040043B11
	8 m	EDP	BSB 35-50 DDK-Stecker 10-pol.	High Flex Leder	7S6SH086040043B11
ABITIG® 18SC	4 m	EDP	BSB 35-50 DDK-Stecker 10-pol.	Standard	7S7SK046040043B11
	8 m	EDP	BSB 35-50 DDK-Stecker 10-pol.	Standard	7S7SK086040043B11
	4 m	EDP	BSB 35-50 DDK-Stecker 10-pol.	High Flex Leder	7S7SH046040043B11
	8 m	EDP	BSB 35-50 DDK-Stecker 10-pol.	High Flex Leder	7S7SH086040043B11
ABITIG® 24W	4 m	EDP	BSB 35-50 DDK-Stecker 10-pol.	Standard	7S9SK046040043B11
	8 m	EDP	BSB 35-50 DDK-Stecker 10-pol.	Standard	7S9SK086040043B11
	4 m	EDP	BSB 35-50 DDK-Stecker 10-pol.	High Flex Leder	7S9SH046040043B11
	8 m	EDP	BSB 35-50 DDK-Stecker 10-pol.	High Flex Leder	7S9SH086040043B11
ABITIG® 450W	4 m	EDP	BSB 35-50 DDK-Stecker 10-pol.	Standard	7T5SK046040143B11
	8 m	EDP	BSB 35-50 DDK-Stecker 10-pol.	Standard	7T5SK086040143B11
	4 m	EDP	BSB 35-50 DDK-Stecker 10-pol.	High Flex Leder	7T5SH046040143B11
	8 m	EDP	BSB 35-50 DDK-Stecker 10-pol.	High Flex Leder	7T5SH086040143B11
ABITIG® 260W	4 m	EDP	BSB 35-50 DDK-Stecker 10-pol.	Standard	7T7SK046040143B11
	8 m	EDP	BSB 35-50 DDK-Stecker 10-pol.	Standard	7T7SK086040143B11
	4 m	EDP	BSB 35-50 DDK-Stecker 10-pol.	High Flex Leder	7T7SH046040143B11
	8 m	EDP	BSB 35-50 DDK-Stecker 10-pol.	High Flex Leder	7T7SH086040143B11
ABITIG® 450W SC	4 m	EDP	BSB 35-50 DDK-Stecker 10-pol.	Standard	
	8 m	EDP	BSB 35-50 DDK-Stecker 10-pol.	Standard	
	4 m	EDP	BSB 35-50 DDK-Stecker 10-pol.	High Flex Leder	7T8SH046040143B11
	8 m	EDP	BSB 35-50 DDK-Stecker 10-pol.	High Flex Leder	7T8SH086040143B11

ABITIG®-Brennerpreisliste

passend für WIG-Stromquellen des Fabrikates „cloos“

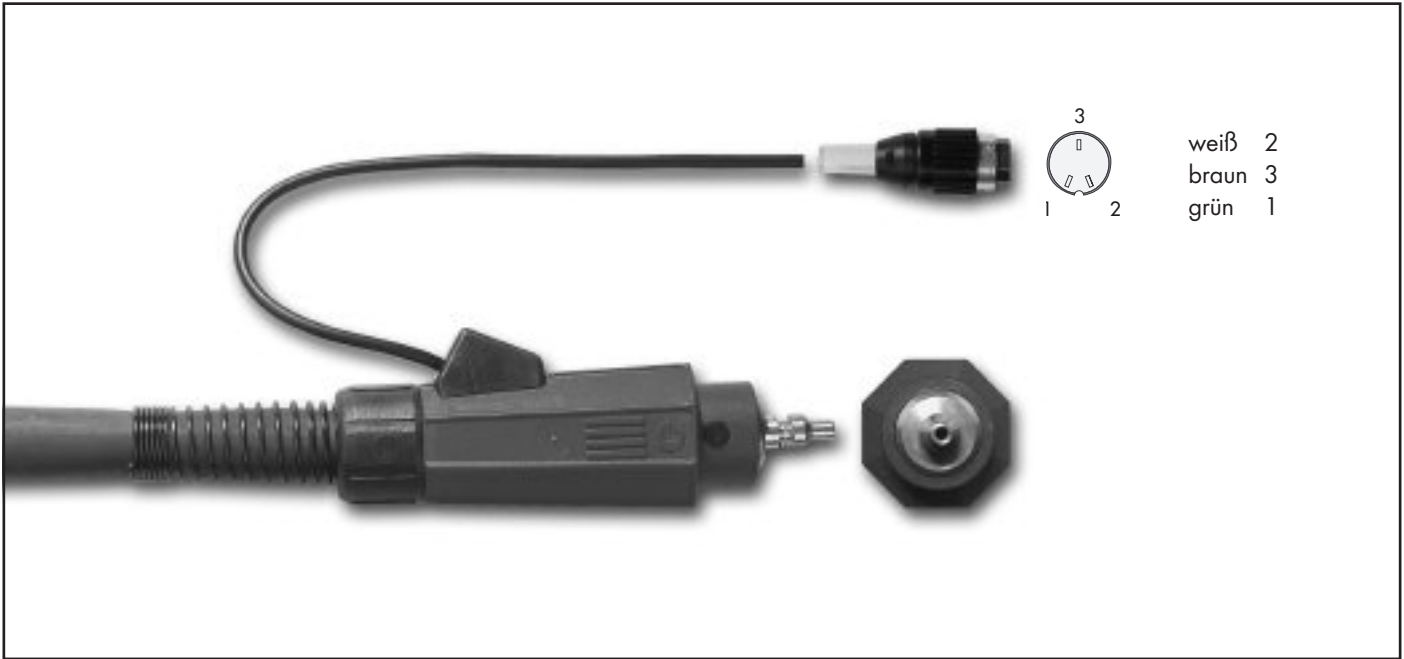

Brennertyp	Länge	Schalterfunktion	maschinenseitiger Anschluss	Schlauchpaketausführung	Bestellnummer
ABITIG® 9	4 m	DD	cloos Tuchel 3-pol.	Standard	7S1SK043020513A00
	8 m	DD	cloos Tuchel 3-pol.	Standard	7S1SK083020513A00
	4 m	DD	cloos Tuchel 3-pol.	High Flex Leder	7S1SH043020513A00
	8 m	DD	cloos Tuchel 3-pol.	High Flex Leder	7S1SH083020513A00

ABITIG® 9F	4 m	DD	cloos Tuchel 3-pol.	Standard	7S1FK043020513A00
	8 m	DD	cloos Tuchel 3-pol.	Standard	7S1FK083020513A00
	4 m	DD	cloos Tuchel 3-pol.	High Flex Leder	7S1FH043020513A00
	8 m	DD	cloos Tuchel 3-pol.	High Flex Leder	7S1FH083020513A00

ABITIG® 17	4 m	DD	cloos Tuchel 3-pol.	Standard	7S2SK043020513A00
	8 m	DD	cloos Tuchel 3-pol.	Standard	7S2SK083020513A00
	4 m	DD	cloos Tuchel 3-pol.	High Flex Leder	7S2SH043020513A00
	8 m	DD	cloos Tuchel 3-pol.	High Flex Leder	7S2SH083020513A00

ABITIG® 17F	4 m	DD	cloos Tuchel 3-pol.	Standard	7S2FK043020513A00
	8 m	DD	cloos Tuchel 3-pol.	Standard	7S2FK083020513A00
	4 m	DD	cloos Tuchel 3-pol.	High Flex Leder	7S2FH043020513A00
	8 m	DD	cloos Tuchel 3-pol.	High Flex Leder	7S2FH083020513A00

Technische Änderungen vorbehalten • Verkaufspreise = unverbindliche Preisempfehlung - Angebot freibleibend • © Copyright

ABITIG®-Brennerpreisliste

passend für WIG-Stromquellen des Fabrikates „cloos“

Brennertyp	Länge	Schalterfunktion	maschinenseitiger Anschluss	Schlauchpaketausführung	Bestellnummer
ABITIG® 26	4 m	DD	cloos Tuchel 3-pol.	Standard	7S3SK043020513A00
	8 m	DD	cloos Tuchel 3-pol.	Standard	7S3SK083020513A00
	4 m	DD	cloos Tuchel 3-pol.	High Flex Leder	7S3SH043020513A00
	8 m	DD	cloos Tuchel 3-pol.	High Flex Leder	7S3SH083020513A00

ABITIG® 26F	4 m	DD	cloos Tuchel 3-pol.	Standard	7S3FK043020513A00
	8 m	DD	cloos Tuchel 3-pol.	Standard	7S3FK083020513A00
	4 m	DD	cloos Tuchel 3-pol.	High Flex Leder	7S3FH043020513A00
	8 m	DD	cloos Tuchel 3-pol.	High Flex Leder	7S3FH083020513A00

ABITIG® 24G	4 m	DD	cloos Tuchel 3-pol.	Standard	7S8SK043020513A00
	8 m	DD	cloos Tuchel 3-pol.	Standard	7S8SK083020513A00
	4 m	DD	cloos Tuchel 3-pol.	High Flex Leder	7S8SH043020513A00
	8 m	DD	cloos Tuchel 3-pol.	High Flex Leder	7S8SH083020513A00

ABITIG® 200	4 m	DD	cloos Tuchel 3-pol.	Standard	7T4SK043020513A00
	8 m	DD	cloos Tuchel 3-pol.	Standard	7T4SK083020513A00
	4 m	DD	cloos Tuchel 3-pol.	High Flex Leder	7T4SH043020513A00
	8 m	DD	cloos Tuchel 3-pol.	High Flex Leder	7T4SH083020513A00

ABITIG® 200F	4 m	DD	cloos Tuchel 3-pol.	Standard	7T4FK043020513A00
	8 m	DD	cloos Tuchel 3-pol.	Standard	7T4FK083020513A00
	4 m	DD	cloos Tuchel 3-pol.	High Flex Leder	7T4FH043020513A00
	8 m	DD	cloos Tuchel 3-pol.	High Flex Leder	7T4FH083020513A00

ABITIG® 150	4 m	DD	cloos Tuchel 3-pol.	Standard	7T6SK043020513A00
	8 m	DD	cloos Tuchel 3-pol.	Standard	7T6SK083020513A00
	4 m	DD	cloos Tuchel 3-pol.	High Flex Leder	7T6SH043020513A00
	8 m	DD	cloos Tuchel 3-pol.	High Flex Leder	7T6SH083020513A00

ABITIG® 150F	4 m	DD	cloos Tuchel 3-pol.	Standard	7T6FK043020513A00
	8 m	DD	cloos Tuchel 3-pol.	Standard	7T6FK083020513A00
	4 m	DD	cloos Tuchel 3-pol.	High Flex Leder	7T6FH043020513A00
	8 m	DD	cloos Tuchel 3-pol.	High Flex Leder	7T6FH083020513A00

ABITIG®-Brennerpreisliste

passend für WIG-Stromquellen des Fabrikates „cloos“



Brennertyp	Länge	Schalterfunktion	maschinenseitiger Anschluss	Schlauchpaketausführung	Bestellnummer
ABITIG® 9	4 m	ED	cloos Tuchel 3-pol.	Standard	7S1SK043010513C00
	8 m	ED	cloos Tuchel 3-pol.	Standard	7S1SK083010513C00
	4 m	ED	cloos Tuchel 3-pol.	High Flex Leder	7S1SH043010513C00
	8 m	ED	cloos Tuchel 3-pol.	High Flex Leder	7S1SH083010513C00
ABITIG® 9F	4 m	ED	cloos Tuchel 3-pol.	Standard	7S1FK043010513C00
	8 m	ED	cloos Tuchel 3-pol.	Standard	7S1FK083010513C00
	4 m	ED	cloos Tuchel 3-pol.	High Flex Leder	7S1FH043010513C00
	8 m	ED	cloos Tuchel 3-pol.	High Flex Leder	7S1FH083010513C00
ABITIG® 17	4 m	ED	cloos Tuchel 3-pol.	Standard	7S2SK043010513C00
	8 m	ED	cloos Tuchel 3-pol.	Standard	7S2SK083010513C00
	4 m	ED	cloos Tuchel 3-pol.	High Flex Leder	7S2SH043010513C00
	8 m	ED	cloos Tuchel 3-pol.	High Flex Leder	7S2SH083010513C00
ABITIG® 17F	4 m	ED	cloos Tuchel 3-pol.	Standard	7S2FK043010513C00
	8 m	ED	cloos Tuchel 3-pol.	Standard	7S2FK083010513C00
	4 m	ED	cloos Tuchel 3-pol.	High Flex Leder	7S2FH043010513C00
	8 m	ED	cloos Tuchel 3-pol.	High Flex Leder	7S2FH083010513C00

Technische Änderungen vorbehalten • Verkaufspreise = unverbindliche Preisempfehlung - Angebot freibleibend • © Copyright

ABITIG®-Brennerpreisliste

passend für WIG-Stromquellen des Fabrikates „cloos“

Brennertyp	Länge	Schalterfunktion	maschinenseitiger Anschluss	Schlauchpaketausführung	Bestellnummer
ABITIG® 26	4 m	ED	cloos Tuchel 3-pol.	Standard	7S3SK043010513C00
	8 m	ED	cloos Tuchel 3-pol.	Standard	7S3SK083010513C00
	4 m	ED	cloos Tuchel 3-pol.	High Flex Leder	7S3SH043010513C00
	8 m	ED	cloos Tuchel 3-pol.	High Flex Leder	7S3SH083010513C00

ABITIG® 26F	4 m	ED	cloos Tuchel 3-pol.	Standard	7S3FK043010513C00
	8 m	ED	cloos Tuchel 3-pol.	Standard	7S3FK083010513C00
	4 m	ED	cloos Tuchel 3-pol.	High Flex Leder	7S3FH043010513C00
	8 m	ED	cloos Tuchel 3-pol.	High Flex Leder	7S3FH083010513C00

ABITIG® 24G	4 m	ED	cloos Tuchel 3-pol.	Standard	7S8SK043010513C00
	8 m	ED	cloos Tuchel 3-pol.	Standard	7S8SK083010513C00
	4 m	ED	cloos Tuchel 3-pol.	High Flex Leder	7S8SH043010513C00
	8 m	ED	cloos Tuchel 3-pol.	High Flex Leder	7S8SH083010513C00

ABITIG® 200	4 m	ED	cloos Tuchel 3-pol.	Standard	7T4SK043010513C00
	8 m	ED	cloos Tuchel 3-pol.	Standard	7T4SK083010513C00
	4 m	ED	cloos Tuchel 3-pol.	High Flex Leder	7T4SH043010513C00
	8 m	ED	cloos Tuchel 3-pol.	High Flex Leder	7T4SH083010513C00

ABITIG® 200F	4 m	ED	cloos Tuchel 3-pol.	Standard	7T4FK043010513C00
	8 m	ED	cloos Tuchel 3-pol.	Standard	7T4FK083010513C00
	4 m	ED	cloos Tuchel 3-pol.	High Flex Leder	7T4FH043010513C00
	8 m	ED	cloos Tuchel 3-pol.	High Flex Leder	7T4FH083010513C00

ABITIG® 150	4 m	ED	cloos Tuchel 3-pol.	Standard	7T6SK043010513C00
	8 m	ED	cloos Tuchel 3-pol.	Standard	7T6SK083010513C00
	4 m	ED	cloos Tuchel 3-pol.	High Flex Leder	7T6SH043010513C00
	8 m	ED	cloos Tuchel 3-pol.	High Flex Leder	7T6SH083010513C00

ABITIG® 150F	4 m	ED	cloos Tuchel 3-pol.	Standard	7T6FK043010513C00
	8 m	ED	cloos Tuchel 3-pol.	Standard	7T6FK083010513C00
	4 m	ED	cloos Tuchel 3-pol.	High Flex Leder	7T6FH043010513C00
	8 m	ED	cloos Tuchel 3-pol.	High Flex Leder	7T6FH083010513C00

ABITIG®-Brennerpreisliste

passend für WIG-Stromquellen des Fabrikates „cloos“

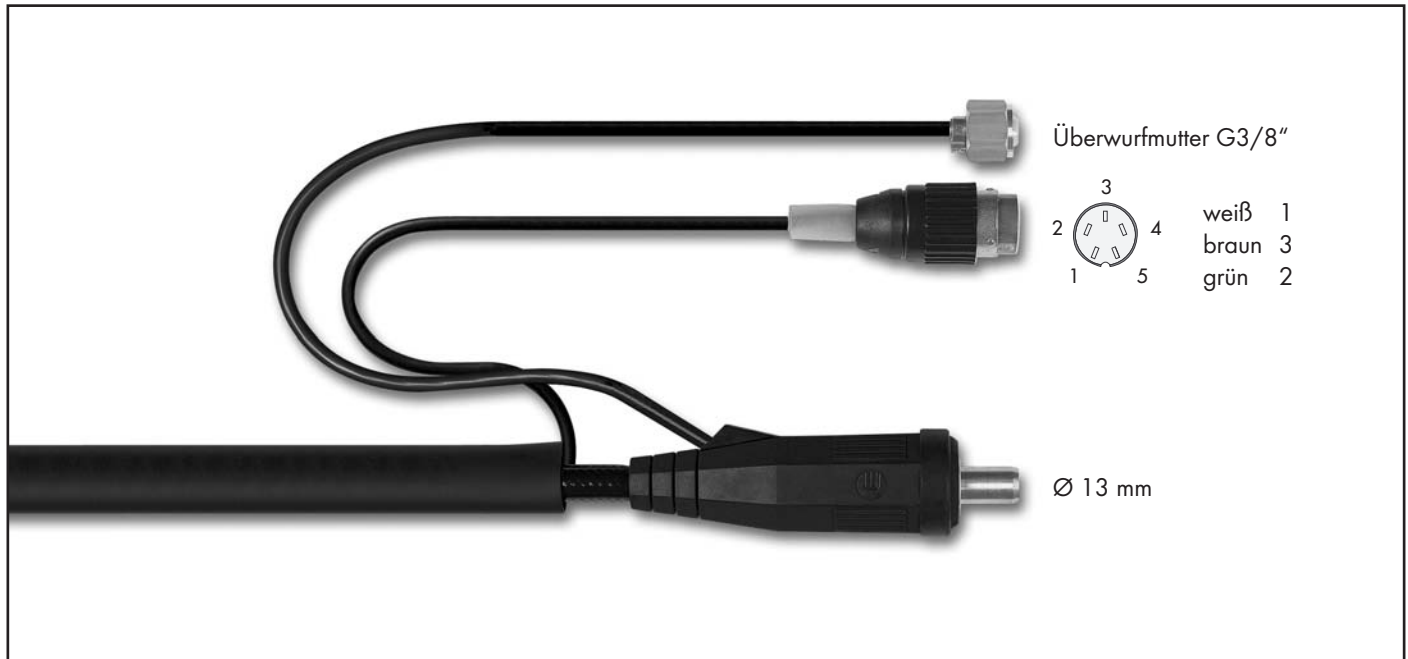

Brennertyp	Länge	Schalterfunktion	maschinenseitiger Anschluss	Schlauchpaketausführung	Bestellnummer
ABITIG® 9	4 m	ED/DD	BSB 35-50 Tuchel 5-pol.	Standard	7S1SK043020001B02
	8 m	ED/DD	BSB 35-50 Tuchel 5-pol.	Standard	7S1SK083020001B02
	4 m	ED/DD	BSB 35-50 Tuchel 5-pol.	High Flex Leder	7S1SH043020001B02
	8 m	ED/DD	BSB 35-50 Tuchel 5-pol.	High Flex Leder	7S1SH083020001B02

ABITIG® 9F	4 m	ED/DD	BSB 35-50 Tuchel 5-pol.	Standard	7S1FK043020001B02
	8 m	ED/DD	BSB 35-50 Tuchel 5-pol.	Standard	7S1FK083020001B02
	4 m	ED/DD	BSB 35-50 Tuchel 5-pol.	High Flex Leder	7S1FH043020001B02
	8 m	ED/DD	BSB 35-50 Tuchel 5-pol.	High Flex Leder	7S1FH083020001B02

ABITIG® 17	4 m	ED/DD	BSB 35-50 Tuchel 5-pol.	Standard	7S2SK043020001B02
	8 m	ED/DD	BSB 35-50 Tuchel 5-pol.	Standard	7S2SK083020001B02
	4 m	ED/DD	BSB 35-50 Tuchel 5-pol.	High Flex Leder	7S2SH043020001B02
	8 m	ED/DD	BSB 35-50 Tuchel 5-pol.	High Flex Leder	7S2SH083020001B02

ABITIG® 17F	4 m	ED/DD	BSB 35-50 Tuchel 5-pol.	Standard	7S2FK043020001B02
	8 m	ED/DD	BSB 35-50 Tuchel 5-pol.	Standard	7S2FK083020001B02
	4 m	ED/DD	BSB 35-50 Tuchel 5-pol.	High Flex Leder	7S2FH043020001B02
	8 m	ED/DD	BSB 35-50 Tuchel 5-pol.	High Flex Leder	7S2FH083020001B02

Technische Änderungen vorbehalten • Verkaufspreise = unverbindliche Preisempfehlung - Angebot freibleibend • © Copyright

ABITIG®-Brennerpreisliste

passend für WIG-Stromquellen des Fabrikates „cloos“

Brennertyp	Länge	Schalterfunktion	maschinenseitiger Anschluss	Schlauchpaketausführung	Bestellnummer
ABITIG® 26	4 m	ED/DD	BSB 35-50 Tuchel 5-pol.	Standard	7S3SK043020001B02
	8 m	ED/DD	BSB 35-50 Tuchel 5-pol.	Standard	7S3SK083020001B02
	4 m	ED/DD	BSB 35-50 Tuchel 5-pol.	High Flex Leder	7S3SH043020001B02
	8 m	ED/DD	BSB 35-50 Tuchel 5-pol.	High Flex Leder	7S3SH083020001B02
ABITIG® 26F	4 m	ED/DD	BSB 35-50 Tuchel 5-pol.	Standard	7S3FK043020001B02
	8 m	ED/DD	BSB 35-50 Tuchel 5-pol.	Standard	7S3FK083020001B02
	4 m	ED/DD	BSB 35-50 Tuchel 5-pol.	High Flex Leder	7S3FH043020001B02
	8 m	ED/DD	BSB 35-50 Tuchel 5-pol.	High Flex Leder	7S3FH083020001B02
ABITIG® 24G	4 m	ED/DD	BSB 35-50 Tuchel 5-pol.	Standard	7S8SK043020001B02
	8 m	ED/DD	BSB 35-50 Tuchel 5-pol.	Standard	7S8SK083020001B02
	4 m	ED/DD	BSB 35-50 Tuchel 5-pol.	High Flex Leder	7S8SH043020001B02
	8 m	ED/DD	BSB 35-50 Tuchel 5-pol.	High Flex Leder	7S8SH083020001B02
ABITIG® 200	4 m	ED/DD	BSB 35-50 Tuchel 5-pol.	Standard	7T4SK043020001B02
	8 m	ED/DD	BSB 35-50 Tuchel 5-pol.	Standard	7T4SK083020001B02
	4 m	ED/DD	BSB 35-50 Tuchel 5-pol.	High Flex Leder	7T4SH043020001B02
	8 m	ED/DD	BSB 35-50 Tuchel 5-pol.	High Flex Leder	7T4SH083020001B02
ABITIG® 200F	4 m	ED/DD	BSB 35-50 Tuchel 5-pol.	Standard	7T4FK043020001B02
	8 m	ED/DD	BSB 35-50 Tuchel 5-pol.	Standard	7T4FK083020001B02
	4 m	ED/DD	BSB 35-50 Tuchel 5-pol.	High Flex Leder	7T4FH043020001B02
	8 m	ED/DD	BSB 35-50 Tuchel 5-pol.	High Flex Leder	7T4FH083020001B02
ABITIG® 150	4 m	ED/DD	BSB 35-50 Tuchel 5-pol.	Standard	7T6SK043020001B02
	8 m	ED/DD	BSB 35-50 Tuchel 5-pol.	Standard	7T6SK083020001B02
	4 m	ED/DD	BSB 35-50 Tuchel 5-pol.	High Flex Leder	7T6SH043020001B02
	8 m	ED/DD	BSB 35-50 Tuchel 5-pol.	High Flex Leder	7T6SH083020001B02
ABITIG® 150F	4 m	ED/DD	BSB 35-50 Tuchel 5-pol.	Standard	7T6FK043020001B02
	8 m	ED/DD	BSB 35-50 Tuchel 5-pol.	Standard	7T6FK083020001B02
	4 m	ED/DD	BSB 35-50 Tuchel 5-pol.	High Flex Leder	7T6FH043020001B02
	8 m	ED/DD	BSB 35-50 Tuchel 5-pol.	High Flex Leder	7T6FH083020001B02

ABITIG®-Brennerpreisliste

passend für WIG-Stromquellen des Fabrikates „cloos“

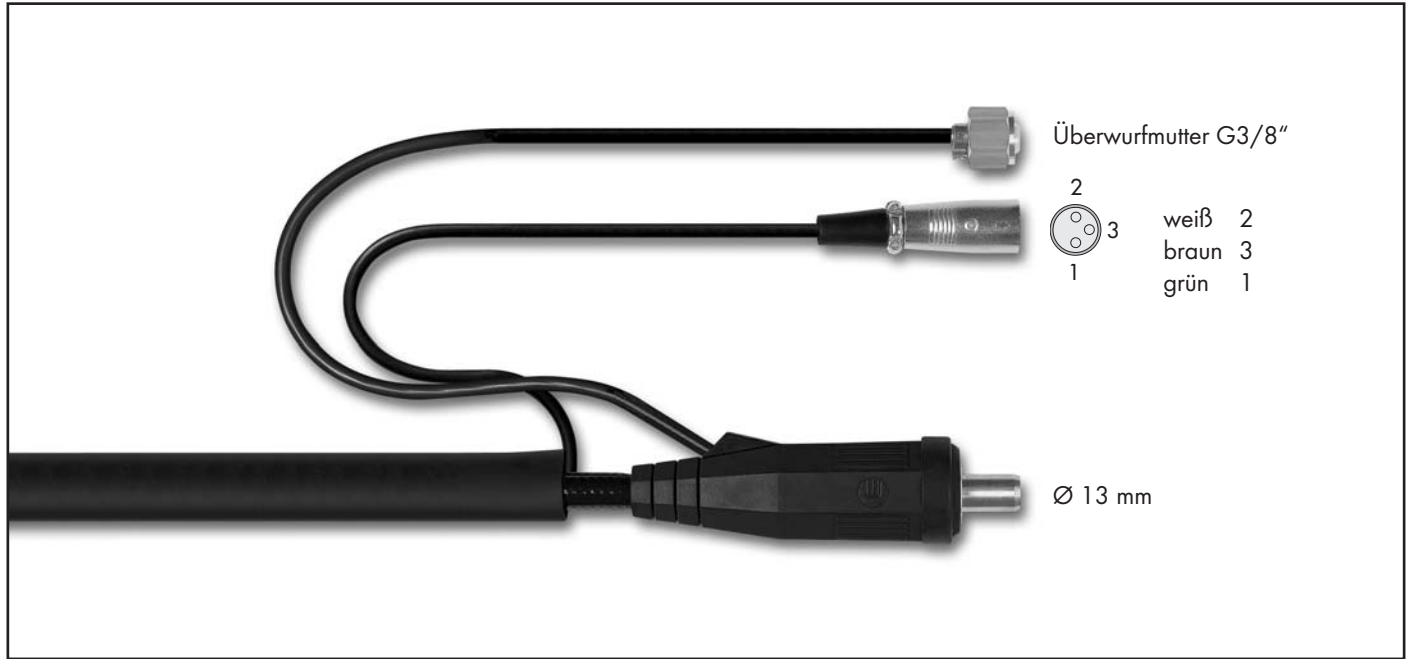

Brennertyp	Länge	Schalterfunktion	maschinenseitiger Anschluss	Schlauchpaketausführung	Bestellnummer
ABITIG® 9	4 m	ED/DD	BSB 35-50 Rundsteckverb. 3-pol.	Standard	7S1SK043020041A02
	8 m	ED/DD	BSB 35-50 Rundsteckverb. 3-pol.	Standard	7S1SK083020041A02
	4 m	ED/DD	BSB 35-50 Rundsteckverb. 3-pol.	High Flex Leder	7S1SH043020041A02
	8 m	ED/DD	BSB 35-50 Rundsteckverb. 3-pol.	High Flex Leder	7S1SH083020041A02
ABITIG® 9F	4 m	ED/DD	BSB 35-50 Rundsteckverb. 3-pol.	Standard	7S1FK043020041A02
	8 m	ED/DD	BSB 35-50 Rundsteckverb. 3-pol.	Standard	7S1FK083020041A02
	4 m	ED/DD	BSB 35-50 Rundsteckverb. 3-pol.	High Flex Leder	7S1FH043020041A02
	8 m	ED/DD	BSB 35-50 Rundsteckverb. 3-pol.	High Flex Leder	7S1FH083020041A02
ABITIG® 17	4 m	ED/DD	BSB 35-50 Rundsteckverb. 3-pol.	Standard	7S2SK043020041A02
	8 m	ED/DD	BSB 35-50 Rundsteckverb. 3-pol.	Standard	7S2SK083020041A02
	4 m	ED/DD	BSB 35-50 Rundsteckverb. 3-pol.	High Flex Leder	7S2SH043020041A02
	8 m	ED/DD	BSB 35-50 Rundsteckverb. 3-pol.	High Flex Leder	7S2SH083020041A02
ABITIG® 17F	4 m	ED/DD	BSB 35-50 Rundsteckverb. 3-pol.	Standard	7S2FK043020041A02
	8 m	ED/DD	BSB 35-50 Rundsteckverb. 3-pol.	Standard	7S2FK083020041A02
	4 m	ED/DD	BSB 35-50 Rundsteckverb. 3-pol.	High Flex Leder	7S2FH043020041A02
	8 m	ED/DD	BSB 35-50 Rundsteckverb. 3-pol.	High Flex Leder	7S2FH083020041A02

Technische Änderungen vorbehalten • Verkaufspreise = unverbindliche Preisempfehlung - Angebot freibleibend • © Copyright

ABITIG®-Brennerpreisliste

passend für WIG-Stromquellen des Fabrikates „cloos“

Brennertyp	Länge	Schalterfunktion	maschinenseitiger Anschluss	Schlauchpaketausführung	Bestellnummer
ABITIG® 26	4 m	ED/DD	BSB 35-50 Rundsteckverb. 3-pol.	Standard	7S3SK043020041A02
	8 m	ED/DD	BSB 35-50 Rundsteckverb. 3-pol.	Standard	7S3SK083020041A02
	4 m	ED/DD	BSB 35-50 Rundsteckverb. 3-pol.	High Flex Leder	7S3SH043020041A02
	8 m	ED/DD	BSB 35-50 Rundsteckverb. 3-pol.	High Flex Leder	7S3SH083020041A02

ABITIG® 26F	4 m	ED/DD	BSB 35-50 Rundsteckverb. 3-pol.	Standard	7S3FK043020041A02
	8 m	ED/DD	BSB 35-50 Rundsteckverb. 3-pol.	Standard	7S3FK083020041A02
	4 m	ED/DD	BSB 35-50 Rundsteckverb. 3-pol.	High Flex Leder	7S3FH043020041A02
	8 m	ED/DD	BSB 35-50 Rundsteckverb. 3-pol.	High Flex Leder	7S3FH083020041A02

ABITIG® 24G	4 m	ED/DD	BSB 35-50 Rundsteckverb. 3-pol.	Standard	7S8SK043020041A02
	8 m	ED/DD	BSB 35-50 Rundsteckverb. 3-pol.	Standard	7S8SK083020041A02
	4 m	ED/DD	BSB 35-50 Rundsteckverb. 3-pol.	High Flex Leder	7S8SH043020041A02
	8 m	ED/DD	BSB 35-50 Rundsteckverb. 3-pol.	High Flex Leder	7S8SH083020041A02

ABITIG® 200	4 m	ED/DD	BSB 35-50 Rundsteckverb. 3-pol.	Standard	7T4SK043020041A02
	8 m	ED/DD	BSB 35-50 Rundsteckverb. 3-pol.	Standard	7T4SK083020041A02
	4 m	ED/DD	BSB 35-50 Rundsteckverb. 3-pol.	High Flex Leder	7T4SH043020041A02
	8 m	ED/DD	BSB 35-50 Rundsteckverb. 3-pol.	High Flex Leder	7T4SH083020041A02

ABITIG® 200F	4 m	ED/DD	BSB 35-50 Rundsteckverb. 3-pol.	Standard	7T4FK043020041A02
	8 m	ED/DD	BSB 35-50 Rundsteckverb. 3-pol.	Standard	7T4FK083020041A02
	4 m	ED/DD	BSB 35-50 Rundsteckverb. 3-pol.	High Flex Leder	7T4FH043020041A02
	8 m	ED/DD	BSB 35-50 Rundsteckverb. 3-pol.	High Flex Leder	7T4FH083020041A02

ABITIG® 150	4 m	ED/DD	BSB 35-50 Rundsteckverb. 3-pol.	Standard	7T6SK043020041A02
	8 m	ED/DD	BSB 35-50 Rundsteckverb. 3-pol.	Standard	7T6SK083020041A02
	4 m	ED/DD	BSB 35-50 Rundsteckverb. 3-pol.	High Flex Leder	7T6SH043020041A02
	8 m	ED/DD	BSB 35-50 Rundsteckverb. 3-pol.	High Flex Leder	7T6SH083020041A02

ABITIG® 150F	4 m	ED/DD	BSB 35-50 Rundsteckverb. 3-pol.	Standard	7T6FK043020041A02
	8 m	ED/DD	BSB 35-50 Rundsteckverb. 3-pol.	Standard	7T6FK083020041A02
	4 m	ED/DD	BSB 35-50 Rundsteckverb. 3-pol.	High Flex Leder	7T6FH043020041A02
	8 m	ED/DD	BSB 35-50 Rundsteckverb. 3-pol.	High Flex Leder	7T6FH083020041A02

ABITIG®-Brennerpreisliste

passend für WIG-Stromquellen des Fabrikates „cloos“



Brennertyp	Länge	Schalterfunktion	maschinenseitiger Anschluss	Schlauchpaketausführung	Bestellnummer
ABITIG® 9	4 m	ED	MAG - ZA	Standard	7S1SK043013496A00
	8 m	ED	MAG - ZA	Standard	7S1SK083013496A00
	4 m	ED	MAG - ZA	High Flex Leder	7S1SH043013496A00
	8 m	ED	MAG - ZA	High Flex Leder	7S1SH083013496A00
ABITIG® 9F	4 m	ED	MAG - ZA	Standard	7S1FK043013496A00
	8 m	ED	MAG - ZA	Standard	7S1FK083013496A00
	4 m	ED	MAG - ZA	High Flex Leder	7S1FH043013496A00
	8 m	ED	MAG - ZA	High Flex Leder	7S1FH083013496A00
ABITIG® 17	4 m	ED	MAG - ZA	Standard	7S2SK043013496A00
	8 m	ED	MAG - ZA	Standard	7S2SK083013496A00
	4 m	ED	MAG - ZA	High Flex Leder	7S2SH043013496A00
	8 m	ED	MAG - ZA	High Flex Leder	7S2SH083013496A00
ABITIG® 17F	4 m	ED	MAG - ZA	Standard	7S2FK043013496A00
	8 m	ED	MAG - ZA	Standard	7S2FK083013496A00
	4 m	ED	MAG - ZA	High Flex Leder	7S2FH043013496A00
	8 m	ED	MAG - ZA	High Flex Leder	7S2FH083013496A00

Technische Änderungen vorbehalten • Verkaufspreise = unverbindliche Preisempfehlung - Angebot freibleibend • © Copyright

ABITIG®-Brennerpreisliste

passend für WIG-Stromquellen des Fabrikates „cloos“

Brennertyp	Länge	Schalterfunktion	maschinenseitiger Anschluss	Schlauchpaketausführung	Bestellnummer
ABITIG® 26	4 m	ED	MAG - ZA	Standard	7S3SK043013496A00
	8 m	ED	MAG - ZA	Standard	7S3SK083013496A00
	4 m	ED	MAG - ZA	High Flex Leder	7S3SH043013496A00
	8 m	ED	MAG - ZA	High Flex Leder	7S3SH083013496A00
ABITIG® 26F	4 m	ED	MAG - ZA	Standard	7S3FK043013496A00
	8 m	ED	MAG - ZA	Standard	7S3FK083013496A00
	4 m	ED	MAG - ZA	High Flex Leder	7S3FH043013496A00
	8 m	ED	MAG - ZA	High Flex Leder	7S3FH083013496A00
ABITIG® 24G	4 m	ED	MAG - ZA	Standard	7S8SK043013496A00
	8 m	ED	MAG - ZA	Standard	7S8SK083013496A00
	4 m	ED	MAG - ZA	High Flex Leder	7S8SH043013496A00
	8 m	ED	MAG - ZA	High Flex Leder	7S8SH083013496A00
ABITIG® 200	4 m	ED	MAG - ZA	Standard	7T4SK043013496A00
	8 m	ED	MAG - ZA	Standard	7T4SK083013496A00
	4 m	ED	MAG - ZA	High Flex Leder	7T4SH043013496A00
	8 m	ED	MAG - ZA	High Flex Leder	7T4SH083013496A00
ABITIG® 200F	4 m	ED	MAG - ZA	Standard	7T4FK043013496A00
	8 m	ED	MAG - ZA	Standard	7T4FK083013496A00
	4 m	ED	MAG - ZA	High Flex Leder	7T4FH043013496A00
	8 m	ED	MAG - ZA	High Flex Leder	7T4FH083013496A00
ABITIG® 150	4 m	ED	MAG - ZA	Standard	7T6SK043013496A00
	8 m	ED	MAG - ZA	Standard	7T6SK083013496A00
	4 m	ED	MAG - ZA	High Flex Leder	7T6SH043013496A00
	8 m	ED	MAG - ZA	High Flex Leder	7T6SH083013496A00
ABITIG® 150F	4 m	ED	MAG - ZA	Standard	7T6FK043013496A00
	8 m	ED	MAG - ZA	Standard	7T6FK083013496A00
	4 m	ED	MAG - ZA	High Flex Leder	7T6FH043013496A00
	8 m	ED	MAG - ZA	High Flex Leder	7T6FH083013496A00

ABITIG®-Brennerpreisliste

passend für WIG-Stromquellen des Fabrikates „cloos“



Brennertyp	Länge	Schalterfunktion	maschinenseitiger Anschluss	Schlauchpaketausführung	Bestellnummer
ABITIG® 18	4 m	DD	cloos Tuchel 3-pol.	Standard	7S4SK043020513A13
	8 m	DD	cloos Tuchel 3-pol.	Standard	7S4SK083020513A13
	4 m	DD	cloos Tuchel 3-pol.	High Flex Leder	7S4SH043020513A13
	8 m	DD	cloos Tuchel 3-pol.	High Flex Leder	7S4SH083020513A13
ABITIG® 18F	4 m	DD	cloos Tuchel 3-pol.	Standard	7S4FK043020513A13
	8 m	DD	cloos Tuchel 3-pol.	Standard	7S4FK083020513A13
	4 m	DD	cloos Tuchel 3-pol.	High Flex Leder	7S4FH043020513A13
	8 m	DD	cloos Tuchel 3-pol.	High Flex Leder	7S4FH083020513A13
ABITIG® 20	4 m	DD	cloos Tuchel 3-pol.	Standard	7S5SK043020513A13
	8 m	DD	cloos Tuchel 3-pol.	Standard	7S5SK083020513A13
	4 m	DD	cloos Tuchel 3-pol.	High Flex Leder	7S5SH043020513A13
	8 m	DD	cloos Tuchel 3-pol.	High Flex Leder	7S5SH083020513A13
ABITIG® 20F	4 m	DD	cloos Tuchel 3-pol.	Standard	7S5FK043020513A13
	8 m	DD	cloos Tuchel 3-pol.	Standard	7S5FK083020513A13
	4 m	DD	cloos Tuchel 3-pol.	High Flex Leder	7S5FH043020513A13
	8 m	DD	cloos Tuchel 3-pol.	High Flex Leder	7S5FH083020513A13

Technische Änderungen vorbehalten • Verkaufspreise = unverbindliche Preisempfehlung - Angebot freibleibend • © Copyright

ABITIG®-Brennerpreisliste

passend für WIG-Stromquellen des Fabrikates „cloos“

Brennertyp	Länge	Schalterfunktion	maschinenseitiger Anschluss	Schlauchpaketausführung	Bestellnummer
ABITIG® 12-1	4 m	DD	cloos Tuchel 3-pol.	Standard	7S6SK043020513A13
	8 m	DD	cloos Tuchel 3-pol.	Standard	7S6SK083020513A13
	4 m	DD	cloos Tuchel 3-pol.	High Flex Leder	7S6SH043020513A13
	8 m	DD	cloos Tuchel 3-pol.	High Flex Leder	7S6SH083020513A13
ABITIG® 18SC	4 m	DD	cloos Tuchel 3-pol.	Standard	7S7SK043020513A13
	8 m	DD	cloos Tuchel 3-pol.	Standard	7S7SK083020513A13
	4 m	DD	cloos Tuchel 3-pol.	High Flex Leder	7S7SH043020513A13
	8 m	DD	cloos Tuchel 3-pol.	High Flex Leder	7S7SH083020513A13
ABITIG® 24W	4 m	DD	cloos Tuchel 3-pol.	Standard	7S9SK043020513A13
	8 m	DD	cloos Tuchel 3-pol.	Standard	7S9SK083020513A13
	4 m	DD	cloos Tuchel 3-pol.	High Flex Leder	7S9SH043020513A13
	8 m	DD	cloos Tuchel 3-pol.	High Flex Leder	7S9SH083020513A13
ABITIG® 450W	4 m	DD	cloos Tuchel 3-pol.	Standard	7T5SK043020513A13
	8 m	DD	cloos Tuchel 3-pol.	Standard	7T5SK083020513A13
	4 m	DD	cloos Tuchel 3-pol.	High Flex Leder	7T5SH043020513A13
	8 m	DD	cloos Tuchel 3-pol.	High Flex Leder	7T5SH083020513A13
ABITIG® 260W	4 m	DD	cloos Tuchel 3-pol.	Standard	7T7SK043020513A13
	8 m	DD	cloos Tuchel 3-pol.	Standard	7T7SK083020513A13
	4 m	DD	cloos Tuchel 3-pol.	High Flex Leder	7T7SH043020513A13
	8 m	DD	cloos Tuchel 3-pol.	High Flex Leder	7T7SH083020513A13
ABITIG® 450W SC	4 m	DD	cloos Tuchel 3-pol.	Standard	
	8 m	DD	cloos Tuchel 3-pol.	Standard	
	4 m	DD	cloos Tuchel 3-pol.	High Flex Leder	7T8SH043020513A13
	8 m	DD	cloos Tuchel 3-pol.	High Flex Leder	7T8SH083020513A13

ABITIG®-Brennerpreisliste

passend für WIG-Stromquellen des Fabrikates „cloos“



Brennertyp	Länge	Schalterfunktion	maschinenseitiger Anschluss	Schlauchpaketausführung	Bestellnummer
ABITIG® 18	4 m	ED	cloos Tuchel 3-pol.	Standard	7S4SK043010513C13
	8 m	ED	cloos Tuchel 3-pol.	Standard	7S4SK083010513C13
	4 m	ED	cloos Tuchel 3-pol.	High Flex Leder	7S4SH043010513C13
	8 m	ED	cloos Tuchel 3-pol.	High Flex Leder	7S4SH083010513C13
ABITIG® 18F	4 m	ED	cloos Tuchel 3-pol.	Standard	7S4FK043010513C13
	8 m	ED	cloos Tuchel 3-pol.	Standard	7S4FK083010513C13
	4 m	ED	cloos Tuchel 3-pol.	High Flex Leder	7S4FH043010513C13
	8 m	ED	cloos Tuchel 3-pol.	High Flex Leder	7S4FH083010513C13
ABITIG® 20	4 m	ED	cloos Tuchel 3-pol.	Standard	7S5SK043010513C13
	8 m	ED	cloos Tuchel 3-pol.	Standard	7S5SK083010513C13
	4 m	ED	cloos Tuchel 3-pol.	High Flex Leder	7S5SH043010513C13
	8 m	ED	cloos Tuchel 3-pol.	High Flex Leder	7S5SH083010513C13
ABITIG® 20F	4 m	ED	cloos Tuchel 3-pol.	Standard	7S5FK043010513C13
	8 m	ED	cloos Tuchel 3-pol.	Standard	7S5FK083010513C13
	4 m	ED	cloos Tuchel 3-pol.	High Flex Leder	7S5FH043010513C13
	8 m	ED	cloos Tuchel 3-pol.	High Flex Leder	7S5FH083010513C13

Technische Änderungen vorbehalten • Verkaufspreise = unverbindliche Preisempfehlung - Angebot freibleibend • © Copyright

ABITIG®-Brennerpreisliste

passend für WIG-Stromquellen des Fabrikates „cloos“

Brennertyp	Länge	Schalterfunktion	maschinenseitiger Anschluss	Schlauchpaketausführung	Bestellnummer
ABITIG® 12-1	4 m	ED	cloos Tuchel 3-pol.	Standard	7S6SK043010513C13
	8 m	ED	cloos Tuchel 3-pol.	Standard	7S6SK083010513C13
	4 m	ED	cloos Tuchel 3-pol.	High Flex Leder	7S6SH043010513C13
	8 m	ED	cloos Tuchel 3-pol.	High Flex Leder	7S6SH083010513C13
ABITIG® 18SC	4 m	ED	cloos Tuchel 3-pol.	Standard	7S7SK043010513C13
	8 m	ED	cloos Tuchel 3-pol.	Standard	7S7SK083010513C13
	4 m	ED	cloos Tuchel 3-pol.	High Flex Leder	7S7SH043010513C13
	8 m	ED	cloos Tuchel 3-pol.	High Flex Leder	7S7SH083010513C13
ABITIG® 24W	4 m	ED	cloos Tuchel 3-pol.	Standard	7S9SK043010513C13
	8 m	ED	cloos Tuchel 3-pol.	Standard	7S9SK083010513C13
	4 m	ED	cloos Tuchel 3-pol.	High Flex Leder	7S9SH043010513C13
	8 m	ED	cloos Tuchel 3-pol.	High Flex Leder	7S9SH083010513C13
ABITIG® 450W	4 m	ED	cloos Tuchel 3-pol.	Standard	7T5SK043010513C13
	8 m	ED	cloos Tuchel 3-pol.	Standard	7T5SK083010513C13
	4 m	ED	cloos Tuchel 3-pol.	High Flex Leder	7T5SH043010513C13
	8 m	ED	cloos Tuchel 3-pol.	High Flex Leder	7T5SH083010513C13
ABITIG® 260W	4 m	ED	cloos Tuchel 3-pol.	Standard	7T7SK043010513C13
	8 m	ED	cloos Tuchel 3-pol.	Standard	7T7SK083010513C13
	4 m	ED	cloos Tuchel 3-pol.	High Flex Leder	7T7SH043010513C13
	8 m	ED	cloos Tuchel 3-pol.	High Flex Leder	7T7SH083010513C13
ABITIG® 450W SC	4 m	ED	cloos Tuchel 3-pol.	Standard	
	8 m	ED	cloos Tuchel 3-pol.	Standard	
	4 m	ED	cloos Tuchel 3-pol.	High Flex Leder	7T8SH043010513C13
	8 m	ED	cloos Tuchel 3-pol.	High Flex Leder	7T8SH083010513C13

ABITIG®-Brennerpreisliste

passend für WIG-Stromquellen des Fabrikates „cloos“

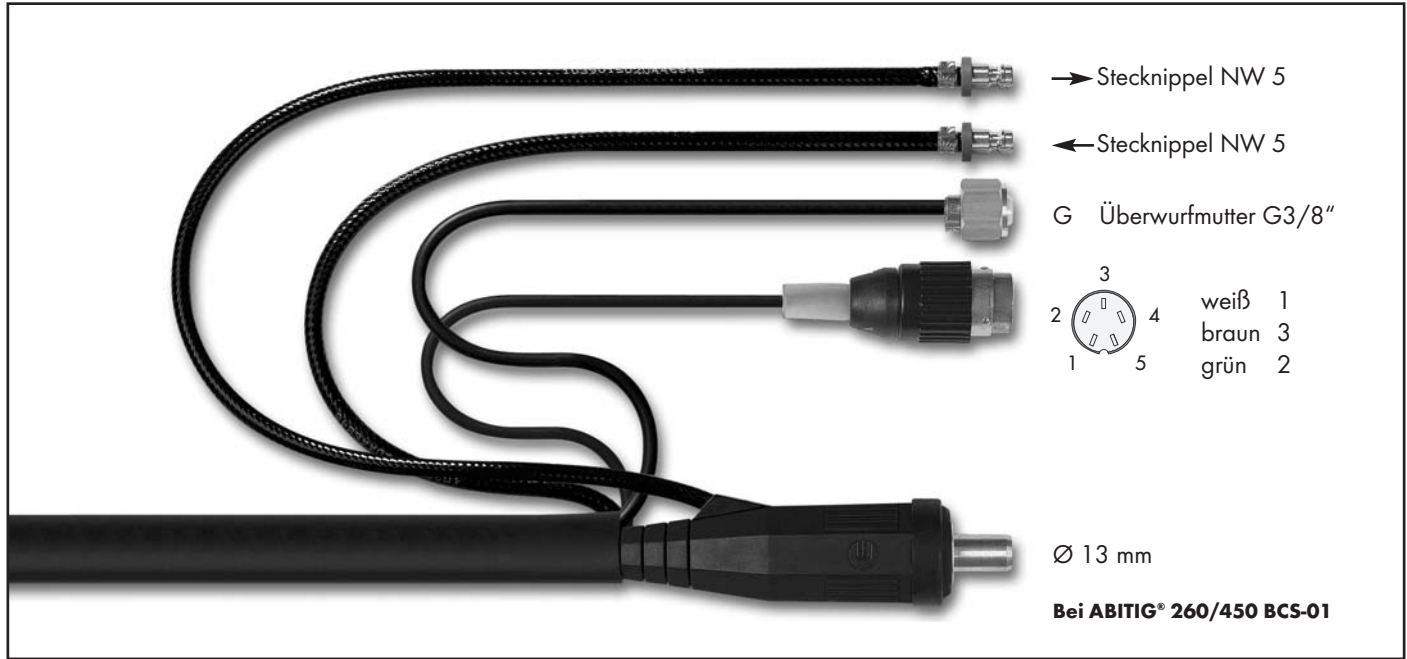

Brennertyp	Länge	Schalterfunktion	maschinenseitiger Anschluss	Schlauchpaketausführung	Bestellnummer
ABITIG® 18	4 m	ED/DD	BSB 35-50 Tuchel 5-pol.	Standard	7S4SK043020001B26
	8 m	ED/DD	BSB 35-50 Tuchel 5-pol.	Standard	7S4SK083020001B26
	4 m	ED/DD	BSB 35-50 Tuchel 5-pol.	High Flex Leder	7S4SH043020001B26
	8 m	ED/DD	BSB 35-50 Tuchel 5-pol.	High Flex Leder	7S4SH083020001B26
ABITIG® 18F	4 m	ED/DD	BSB 35-50 Tuchel 5-pol.	Standard	7S4FK043020001B26
	8 m	ED/DD	BSB 35-50 Tuchel 5-pol.	Standard	7S4FK083020001B26
	4 m	ED/DD	BSB 35-50 Tuchel 5-pol.	High Flex Leder	7S4FH043020001B26
	8 m	ED/DD	BSB 35-50 Tuchel 5-pol.	High Flex Leder	7S4FH083020001B26
ABITIG® 20	4 m	ED/DD	BSB 35-50 Tuchel 5-pol.	Standard	7S5SK043020001B26
	8 m	ED/DD	BSB 35-50 Tuchel 5-pol.	Standard	7S5SK083020001B26
	4 m	ED/DD	BSB 35-50 Tuchel 5-pol.	High Flex Leder	7S5SH043020001B26
	8 m	ED/DD	BSB 35-50 Tuchel 5-pol.	High Flex Leder	7S5SH083020001B26
ABITIG® 20F	4 m	ED/DD	BSB 35-50 Tuchel 5-pol.	Standard	7S5FK043020001B26
	8 m	ED/DD	BSB 35-50 Tuchel 5-pol.	Standard	7S5FK083020001B26
	4 m	ED/DD	BSB 35-50 Tuchel 5-pol.	High Flex Leder	7S5FH043020001B26
	8 m	ED/DD	BSB 35-50 Tuchel 5-pol.	High Flex Leder	7S5FH083020001B26

Technische Änderungen vorbehalten • Verkaufspreise = unverbindliche Preisempfehlung - Angebot freibleibend • © Copyright

ABITIG®-Brennerpreisliste

passend für WIG-Stromquellen des Fabrikates „cloos“

Brennertyp	Länge	Schalterfunktion	maschinenseitiger Anschluss	Schlauchpaketausführung	Bestellnummer
ABITIG® 12-1	4 m	ED/DD	BSB 35-50 Tuchel 5-pol.	Standard	7S6SK043020001B26
	8 m	ED/DD	BSB 35-50 Tuchel 5-pol.	Standard	7S6SK083020001B26
	4 m	ED/DD	BSB 35-50 Tuchel 5-pol.	High Flex Leder	7S6SH043020001B26
	8 m	ED/DD	BSB 35-50 Tuchel 5-pol.	High Flex Leder	7S6SH083020001B26

ABITIG® 18SC	4 m	ED/DD	BSB 35-50 Tuchel 5-pol.	Standard	7S7SK043020001B26
	8 m	ED/DD	BSB 35-50 Tuchel 5-pol.	Standard	7S7SK083020001B26
	4 m	ED/DD	BSB 35-50 Tuchel 5-pol.	High Flex Leder	7S7SH043020001B26
	8 m	ED/DD	BSB 35-50 Tuchel 5-pol.	High Flex Leder	7S7SH083020001B26

ABITIG® 24W	4 m	ED/DD	BSB 35-50 Tuchel 5-pol.	Standard	7S9SK043020001B26
	8 m	ED/DD	BSB 35-50 Tuchel 5-pol.	Standard	7S9SK083020001B26
	4 m	ED/DD	BSB 35-50 Tuchel 5-pol.	High Flex Leder	7S9SH043020001B26
	8 m	ED/DD	BSB 35-50 Tuchel 5-pol.	High Flex Leder	7S9SH083020001B26

ABITIG® 450W	4 m	ED/DD	BSB 35-50 Tuchel 5-pol.	Standard	7T5SK043020101B26
	8 m	ED/DD	BSB 35-50 Tuchel 5-pol.	Standard	7T5SK083020101B26
	4 m	ED/DD	BSB 35-50 Tuchel 5-pol.	High Flex Leder	7T5SH043020101B26
	8 m	ED/DD	BSB 35-50 Tuchel 5-pol.	High Flex Leder	7T5SH083020101B26

ABITIG® 260W	4 m	ED/DD	BSB 35-50 Tuchel 5-pol.	Standard	7T7SK043020101B26
	8 m	ED/DD	BSB 35-50 Tuchel 5-pol.	Standard	7T7SK083020101B26
	4 m	ED/DD	BSB 35-50 Tuchel 5-pol.	High Flex Leder	7T7SH043020101B26
	8 m	ED/DD	BSB 35-50 Tuchel 5-pol.	High Flex Leder	7T7SH083020101B26

ABITIG® 450W SC	4 m	ED/DD	BSB 35-50 Tuchel 5-pol.	Standard	
	8 m	ED/DD	BSB 35-50 Tuchel 5-pol.	Standard	
	4 m	ED/DD	BSB 35-50 Tuchel 5-pol.	High Flex Leder	7T8SH043020101B26
	8 m	ED/DD	BSB 35-50 Tuchel 5-pol.	High Flex Leder	7T8SH083020101B26

ABITIG®-Brennerpreisliste

passend für WIG-Stromquellen des Fabrikates „cloos“

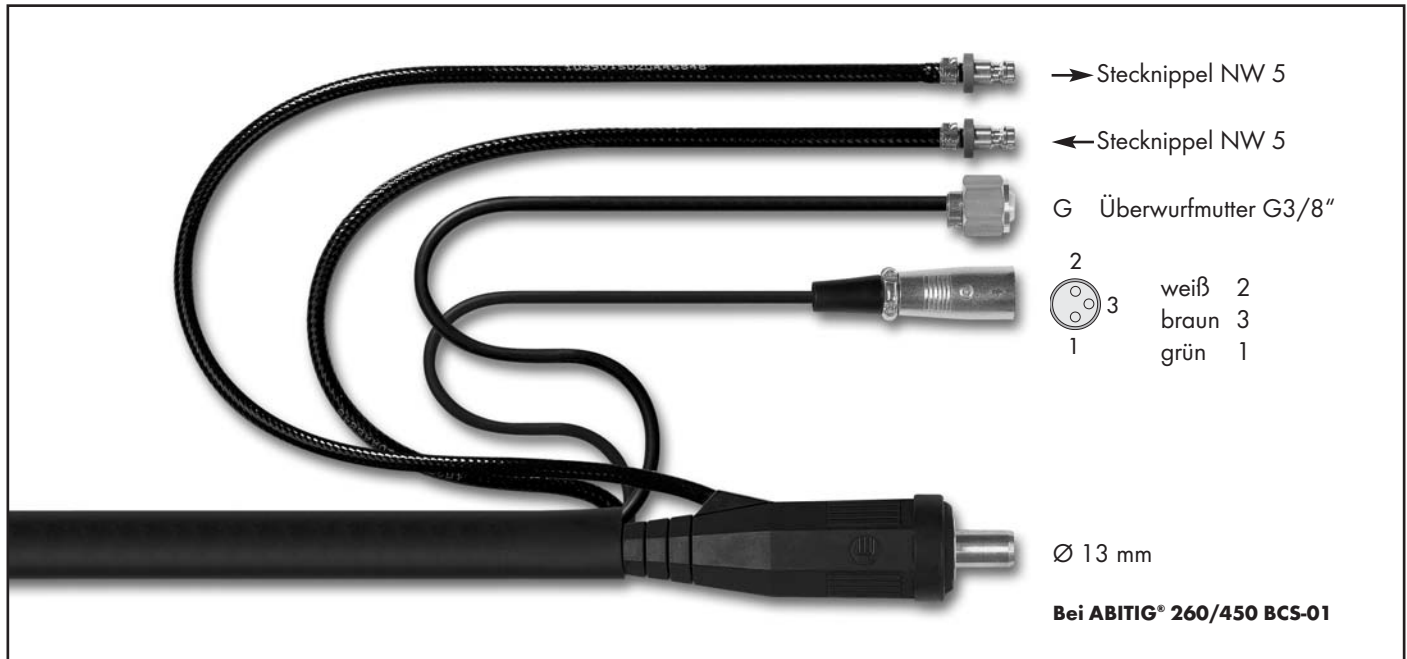

Brennertyp	Länge	Schalterfunktion	maschinenseitiger Anschluss	Schlauchpaketausführung	Bestellnummer
ABITIG® 18	4 m	ED/DD	BSB 35-50 Rundsteckverb. 3-pol.	Standard	7S4SK043020041A26
	8 m	ED/DD	BSB 35-50 Rundsteckverb. 3-pol.	Standard	7S4SK083020041A26
	4 m	ED/DD	BSB 35-50 Rundsteckverb. 3-pol.	High Flex Leder	7S4SH043020041A26
	8 m	ED/DD	BSB 35-50 Rundsteckverb. 3-pol.	High Flex Leder	7S4SH083020041A26
ABITIG® 18F	4 m	ED/DD	BSB 35-50 Rundsteckverb. 3-pol.	Standard	7S4FK043020041A26
	8 m	ED/DD	BSB 35-50 Rundsteckverb. 3-pol.	Standard	7S4FK083020041A26
	4 m	ED/DD	BSB 35-50 Rundsteckverb. 3-pol.	High Flex Leder	7S4FH043020041A26
	8 m	ED/DD	BSB 35-50 Rundsteckverb. 3-pol.	High Flex Leder	7S4FH083020041A26
ABITIG® 20	4 m	ED/DD	BSB 35-50 Rundsteckverb. 3-pol.	Standard	7S5SK043020041A26
	8 m	ED/DD	BSB 35-50 Rundsteckverb. 3-pol.	Standard	7S5SK083020041A26
	4 m	ED/DD	BSB 35-50 Rundsteckverb. 3-pol.	High Flex Leder	7S5SH043020041A26
	8 m	ED/DD	BSB 35-50 Rundsteckverb. 3-pol.	High Flex Leder	7S5SH083020041A26
ABITIG® 20F	4 m	ED/DD	BSB 35-50 Rundsteckverb. 3-pol.	Standard	7S5FK043020041A26
	8 m	ED/DD	BSB 35-50 Rundsteckverb. 3-pol.	Standard	7S5FK083020041A26
	4 m	ED/DD	BSB 35-50 Rundsteckverb. 3-pol.	High Flex Leder	7S5FH043020041A26
	8 m	ED/DD	BSB 35-50 Rundsteckverb. 3-pol.	High Flex Leder	7S5FH083020041A26

Technische Änderungen vorbehalten • Verkaufspreise = unverbindliche Preisempfehlung - Angebot freibleibend • © Copyright

ABITIG®-Brennerpreisliste

passend für WIG-Stromquellen des Fabrikates „cloos“

Brennertyp	Länge	Schalterfunktion	maschinenseitiger Anschluss	Schlauchpaketausführung	Bestellnummer
ABITIG® 12-1	4 m	ED/DD	BSB 35-50 Rundsteckverb. 3-pol.	Standard	7S6SK043020041A26
	8 m	ED/DD	BSB 35-50 Rundsteckverb. 3-pol.	Standard	7S6SK083020041A26
	4 m	ED/DD	BSB 35-50 Rundsteckverb. 3-pol.	High Flex Leder	7S6SH043020041A26
	8 m	ED/DD	BSB 35-50 Rundsteckverb. 3-pol.	High Flex Leder	7S6SH083020041A26
ABITIG® 18SC	4 m	ED/DD	BSB 35-50 Rundsteckverb. 3-pol.	Standard	7S7SK043020041A26
	8 m	ED/DD	BSB 35-50 Rundsteckverb. 3-pol.	Standard	7S7SK083020041A26
	4 m	ED/DD	BSB 35-50 Rundsteckverb. 3-pol.	High Flex Leder	7S7SH043020041A26
	8 m	ED/DD	BSB 35-50 Rundsteckverb. 3-pol.	High Flex Leder	7S7SH083020041A26
ABITIG® 24W	4 m	ED/DD	BSB 35-50 Rundsteckverb. 3-pol.	Standard	7S9SK043020041A26
	8 m	ED/DD	BSB 35-50 Rundsteckverb. 3-pol.	Standard	7S9SK083020041A26
	4 m	ED/DD	BSB 35-50 Rundsteckverb. 3-pol.	High Flex Leder	7S9SH043020041A26
	8 m	ED/DD	BSB 35-50 Rundsteckverb. 3-pol.	High Flex Leder	7S9SH083020041A26
ABITIG® 450W	4 m	ED/DD	BSB 35-50 Rundsteckverb. 3-pol.	Standard	7T5SK043020141A26
	8 m	ED/DD	BSB 35-50 Rundsteckverb. 3-pol.	Standard	7T5SK083020141A26
	4 m	ED/DD	BSB 35-50 Rundsteckverb. 3-pol.	High Flex Leder	7T5SH043020141A26
	8 m	ED/DD	BSB 35-50 Rundsteckverb. 3-pol.	High Flex Leder	7T5SH083020141A26
ABITIG® 260W	4 m	ED/DD	BSB 35-50 Rundsteckverb. 3-pol.	Standard	7T7SK043020141A26
	8 m	ED/DD	BSB 35-50 Rundsteckverb. 3-pol.	Standard	7T7SK083020141A26
	4 m	ED/DD	BSB 35-50 Rundsteckverb. 3-pol.	High Flex Leder	7T7SH043020141A26
	8 m	ED/DD	BSB 35-50 Rundsteckverb. 3-pol.	High Flex Leder	7T7SH083020141A26
ABITIG® 450W SC	4 m	ED/DD	BSB 35-50 Rundsteckverb. 3-pol.	Standard	
	8 m	ED/DD	BSB 35-50 Rundsteckverb. 3-pol.	Standard	
	4 m	ED/DD	BSB 35-50 Rundsteckverb. 3-pol.	High Flex Leder	7T8SH043020141A26
	8 m	ED/DD	BSB 35-50 Rundsteckverb. 3-pol.	High Flex Leder	7T8SH083020141A26

ABITIG®-Brennerpreisliste

passend für WIG-Stromquellen des Fabrikates „d+l“



Brennertyp	Länge	Schalterfunktion	maschinenseitiger Anschluss	Schlauchpaketausführung	Bestellnummer
ABITIG® 9	4 m	ED	BSB 10-25 Tuchel 5-pol.	Standard	7S1SK043012201A01
	8 m	ED	BSB 10-25 Tuchel 5-pol.	Standard	7S1SK083012201A01
	4 m	ED	BSB 10-25 Tuchel 5-pol.	High Flex Leder	7S1SH043012201A01
	8 m	ED	BSB 10-25 Tuchel 5-pol.	High Flex Leder	7S1SH083012201A01

ABITIG® 9F	4 m	ED	BSB 10-25 Tuchel 5-pol.	Standard	7S1FK043012201A01
	8 m	ED	BSB 10-25 Tuchel 5-pol.	Standard	7S1FK083012201A01
	4 m	ED	BSB 10-25 Tuchel 5-pol.	High Flex Leder	7S1FH043012201A01
	8 m	ED	BSB 10-25 Tuchel 5-pol.	High Flex Leder	7S1FH083012201A01

ABITIG® 17	4 m	ED	BSB 10-25 Tuchel 5-pol.	Standard	7S2SK043012201A01
	8 m	ED	BSB 10-25 Tuchel 5-pol.	Standard	7S2SK083012201A01
	4 m	ED	BSB 10-25 Tuchel 5-pol.	High Flex Leder	7S2SH043012201A01
	8 m	ED	BSB 10-25 Tuchel 5-pol.	High Flex Leder	7S2SH083012201A01

ABITIG® 17F	4 m	ED	BSB 10-25 Tuchel 5-pol.	Standard	7S2FK043012201A01
	8 m	ED	BSB 10-25 Tuchel 5-pol.	Standard	7S2FK083012201A01
	4 m	ED	BSB 10-25 Tuchel 5-pol.	High Flex Leder	7S2FH043012201A01
	8 m	ED	BSB 10-25 Tuchel 5-pol.	High Flex Leder	7S2FH083012201A01

Technische Änderungen vorbehalten • Verkaufspreise = unverbindliche Preisempfehlung - Angebot freibleibend • © Copyright

ABITIG[®]-Brennerpreisliste

passend für WIG-Stromquellen des Fabrikates „d+l“

Brennertyp	Länge	Schalterfunktion	maschinenseitiger Anschluss	Schlauchpaketausführung	Bestellnummer
ABITIG [®] 26					
ABITIG [®] 26F					
ABITIG [®] 24G					
	4 m	ED	BSB 10-25 Tuchel 5-pol.	Standard	7S8SK043012201A01
	8 m	ED	BSB 10-25 Tuchel 5-pol.	Standard	7S8SK083012201A01
	4 m	ED	BSB 10-25 Tuchel 5-pol.	High Flex Leder	7S8SH043012201A01
	8 m	ED	BSB 10-25 Tuchel 5-pol.	High Flex Leder	7S8SH083012201A01
ABITIG [®] 200					
ABITIG [®] 200F					
ABITIG [®] 150					
	4 m	ED	BSB 10-25 Tuchel 5-pol.	Standard	7T6SK043012201A01
	8 m	ED	BSB 10-25 Tuchel 5-pol.	Standard	7T6SK083012201A01
	4 m	ED	BSB 10-25 Tuchel 5-pol.	High Flex Leder	7T6SH043012201A01
	8 m	ED	BSB 10-25 Tuchel 5-pol.	High Flex Leder	7T6SH083012201A01
ABITIG [®] 150F					
	4 m	ED	BSB 10-25 Tuchel 5-pol.	Standard	7T6FK043012201A01
	8 m	ED	BSB 10-25 Tuchel 5-pol.	Standard	7T6FK083012201A01
	4 m	ED	BSB 10-25 Tuchel 5-pol.	High Flex Leder	7T6FH043012201A01
	8 m	ED	BSB 10-25 Tuchel 5-pol.	High Flex Leder	7T6FH083012201A01

ABITIG®-Brennerpreisliste

passend für WIG-Stromquellen des Fabrikates „d+l“



Brennertyp	Länge	Schalterfunktion	maschinenseitiger Anschluss	Schlauchpaketausführung	Bestellnummer
ABITIG® 9	4 m	ED	BSB 35-50 Tuchel 5-pol.	Standard	7S1SK043010001A01
	8 m	ED	BSB 35-50 Tuchel 5-pol.	Standard	7S1SK083010001A01
	4 m	ED	BSB 35-50 Tuchel 5-pol.	High Flex Leder	7S1SH043010001A01
	8 m	ED	BSB 35-50 Tuchel 5-pol.	High Flex Leder	7S1SH083010001A01
ABITIG® 9F	4 m	ED	BSB 35-50 Tuchel 5-pol.	Standard	7S1FK043010001A01
	8 m	ED	BSB 35-50 Tuchel 5-pol.	Standard	7S1FK083010001A01
	4 m	ED	BSB 35-50 Tuchel 5-pol.	High Flex Leder	7S1FH043010001A01
	8 m	ED	BSB 35-50 Tuchel 5-pol.	High Flex Leder	7S1FH083010001A01
ABITIG® 17	4 m	ED	BSB 35-50 Tuchel 5-pol.	Standard	7S2SK043010001A01
	8 m	ED	BSB 35-50 Tuchel 5-pol.	Standard	7S2SK083010001A01
	4 m	ED	BSB 35-50 Tuchel 5-pol.	High Flex Leder	7S2SH043010001A01
	8 m	ED	BSB 35-50 Tuchel 5-pol.	High Flex Leder	7S2SH083010001A01
ABITIG® 17F	4 m	ED	BSB 35-50 Tuchel 5-pol.	Standard	7S2FK043010001A01
	8 m	ED	BSB 35-50 Tuchel 5-pol.	Standard	7S2FK083010001A01
	4 m	ED	BSB 35-50 Tuchel 5-pol.	High Flex Leder	7S2FH043010001A01
	8 m	ED	BSB 35-50 Tuchel 5-pol.	High Flex Leder	7S2FH083010001A01

Technische Änderungen vorbehalten • Verkaufspreise = unverbindliche Preisempfehlung - Angebot freibleibend • © Copyright

ABITIG®-Brennerpreisliste

passend für WIG-Stromquellen des Fabrikates „d+l“

Brennertyp	Länge	Schalterfunktion	maschinenseitiger Anschluss	Schlauchpaketausführung	Bestellnummer
ABITIG® 26	4 m	ED	BSB 35-50 Tuchel 5-pol.	Standard	7S3SK043010001A01
	8 m	ED	BSB 35-50 Tuchel 5-pol.	Standard	7S3SK083010001A01
	4 m	ED	BSB 35-50 Tuchel 5-pol.	High Flex Leder	7S3SH043010001A01
	8 m	ED	BSB 35-50 Tuchel 5-pol.	High Flex Leder	7S3SH083010001A01
ABITIG® 26F	4 m	ED	BSB 35-50 Tuchel 5-pol.	Standard	7S3FK043010001A01
	8 m	ED	BSB 35-50 Tuchel 5-pol.	Standard	7S3FK083010001A01
	4 m	ED	BSB 35-50 Tuchel 5-pol.	High Flex Leder	7S3FH043010001A01
	8 m	ED	BSB 35-50 Tuchel 5-pol.	High Flex Leder	7S3FH083010001A01
ABITIG® 24G	4 m	ED	BSB 35-50 Tuchel 5-pol.	Standard	7S8SK043010001A01
	8 m	ED	BSB 35-50 Tuchel 5-pol.	Standard	7S8SK083010001A01
	4 m	ED	BSB 35-50 Tuchel 5-pol.	High Flex Leder	7S8SH043010001A01
	8 m	ED	BSB 35-50 Tuchel 5-pol.	High Flex Leder	7S8SH083010001A01
ABITIG® 200	4 m	ED	BSB 35-50 Tuchel 5-pol.	Standard	7T4SK043010001A01
	8 m	ED	BSB 35-50 Tuchel 5-pol.	Standard	7T4SK083010001A01
	4 m	ED	BSB 35-50 Tuchel 5-pol.	High Flex Leder	7T4SH043010001A01
	8 m	ED	BSB 35-50 Tuchel 5-pol.	High Flex Leder	7T4SH083010001A01
ABITIG® 200F	4 m	ED	BSB 35-50 Tuchel 5-pol.	Standard	7T4FK043010001A01
	8 m	ED	BSB 35-50 Tuchel 5-pol.	Standard	7T4FK083010001A01
	4 m	ED	BSB 35-50 Tuchel 5-pol.	High Flex Leder	7T4FH043010001A01
	8 m	ED	BSB 35-50 Tuchel 5-pol.	High Flex Leder	7T4FH083010001A01
ABITIG® 150	4 m	ED	BSB 35-50 Tuchel 5-pol.	Standard	7T6SK043010001A01
	8 m	ED	BSB 35-50 Tuchel 5-pol.	Standard	7T6SK083010001A01
	4 m	ED	BSB 35-50 Tuchel 5-pol.	High Flex Leder	7T6SH043010001A01
	8 m	ED	BSB 35-50 Tuchel 5-pol.	High Flex Leder	7T6SH083010001A01
ABITIG® 150F	4 m	ED	BSB 35-50 Tuchel 5-pol.	Standard	7T6FK043010001A01
	8 m	ED	BSB 35-50 Tuchel 5-pol.	Standard	7T6FK083010001A01
	4 m	ED	BSB 35-50 Tuchel 5-pol.	High Flex Leder	7T6FH043010001A01
	8 m	ED	BSB 35-50 Tuchel 5-pol.	High Flex Leder	7T6FH083010001A01

ABITIG®-Brennerpreisliste

passend für WIG-Stromquellen des Fabrikates „d+l“



Brennertyp	Länge	Schalterfunktion	maschinenseitiger Anschluss	Schlauchpaketausführung	Bestellnummer
ABITIG® 18	4 m	ED	BSB 35-50 Tuchel 5-pol.	Standard	7S4SK043010001A11
	8 m	ED	BSB 35-50 Tuchel 5-pol.	Standard	7S4SK083010001A11
	4 m	ED	BSB 35-50 Tuchel 5-pol.	High Flex Leder	7S4SH043010001A11
	8 m	ED	BSB 35-50 Tuchel 5-pol.	High Flex Leder	7S4SH083010001A11
ABITIG® 18F	4 m	ED	BSB 35-50 Tuchel 5-pol.	Standard	7S4FK043010001A11
	8 m	ED	BSB 35-50 Tuchel 5-pol.	Standard	7S4FK083010001A11
	4 m	ED	BSB 35-50 Tuchel 5-pol.	High Flex Leder	7S4FH043010001A11
	8 m	ED	BSB 35-50 Tuchel 5-pol.	High Flex Leder	7S4FH083010001A11
ABITIG® 20	4 m	ED	BSB 35-50 Tuchel 5-pol.	Standard	7S5SK043010001A11
	8 m	ED	BSB 35-50 Tuchel 5-pol.	Standard	7S5SK083010001A11
	4 m	ED	BSB 35-50 Tuchel 5-pol.	High Flex Leder	7S5SH043010001A11
	8 m	ED	BSB 35-50 Tuchel 5-pol.	High Flex Leder	7S5SH083010001A11
ABITIG® 20F	4 m	ED	BSB 35-50 Tuchel 5-pol.	Standard	7S5FK043010001A11
	8 m	ED	BSB 35-50 Tuchel 5-pol.	Standard	7S5FK083010001A11
	4 m	ED	BSB 35-50 Tuchel 5-pol.	High Flex Leder	7S5FH043010001A11
	8 m	ED	BSB 35-50 Tuchel 5-pol.	High Flex Leder	7S5FH083010001A11

Technische Änderungen vorbehalten • Verkaufspreise = unverbindliche Preisempfehlung - Angebot freibleibend • © Copyright

ABITIG®-Brennerpreisliste

passend für WIG-Stromquellen des Fabrikates „d+l“

Brennertyp	Länge	Schalterfunktion	maschinenseitiger Anschluss	Schlauchpaketausführung	Bestellnummer
ABITIG® 12-1	4 m	ED	BSB 35-50 Tuchel 5-pol.	Standard	7S6SK043010001A11
	8 m	ED	BSB 35-50 Tuchel 5-pol.	Standard	7S6SK083010001A11
	4 m	ED	BSB 35-50 Tuchel 5-pol.	High Flex Leder	7S6SH043010001A11
	8 m	ED	BSB 35-50 Tuchel 5-pol.	High Flex Leder	7S6SH083010001A11

ABITIG® 18SC	4 m	ED	BSB 35-50 Tuchel 5-pol.	Standard	7S7SK043010001A11
	8 m	ED	BSB 35-50 Tuchel 5-pol.	Standard	7S7SK083010001A11
	4 m	ED	BSB 35-50 Tuchel 5-pol.	High Flex Leder	7S7SH043010001A11
	8 m	ED	BSB 35-50 Tuchel 5-pol.	High Flex Leder	7S7SH083010001A11

ABITIG® 24W	4 m	ED	BSB 35-50 Tuchel 5-pol.	Standard	7S9SK043010001A11
	8 m	ED	BSB 35-50 Tuchel 5-pol.	Standard	7S9SK083010001A11
	4 m	ED	BSB 35-50 Tuchel 5-pol.	High Flex Leder	7S9SH043010001A11
	8 m	ED	BSB 35-50 Tuchel 5-pol.	High Flex Leder	7S9SH083010001A11

ABITIG® 450W	4 m	ED	BSB 35-50 Tuchel 5-pol.	Standard	7T5SK043010101A11
	8 m	ED	BSB 35-50 Tuchel 5-pol.	Standard	7T5SK083010101A11
	4 m	ED	BSB 35-50 Tuchel 5-pol.	High Flex Leder	7T5SH043010101A11
	8 m	ED	BSB 35-50 Tuchel 5-pol.	High Flex Leder	7T5SH083010101A11

ABITIG® 260W	4 m	ED	BSB 35-50 Tuchel 5-pol.	Standard	7T7SK043010101A11
	8 m	ED	BSB 35-50 Tuchel 5-pol.	Standard	7T7SK083010101A11
	4 m	ED	BSB 35-50 Tuchel 5-pol.	High Flex Leder	7T7SH043010101A11
	8 m	ED	BSB 35-50 Tuchel 5-pol.	High Flex Leder	7T7SH083010101A11

ABITIG® 450W SC	4 m	ED	BSB 35-50 Tuchel 5-pol.	Standard	
	8 m	ED	BSB 35-50 Tuchel 5-pol.	Standard	
	4 m	ED	BSB 35-50 Tuchel 5-pol.	High Flex Leder	7T8SH043010101A11
	8 m	ED	BSB 35-50 Tuchel 5-pol.	High Flex Leder	7T8SH083010101A11

ABITIG®-Brennerpreisliste

passend für WIG-Stromquellen des Fabrikates „dalex“

Für dieses Gerätefabrikat ist in der Bestellnummer und somit auch im Lieferumfang das Ansteuermodul BIS-10 enthalten. Das Ansteuermodul BIS-10 enthält im Gegensatz zu BIS-02 die verstärkte Schalterausführung (2x) wegen der geräteabhängigen höheren Schaltströme.

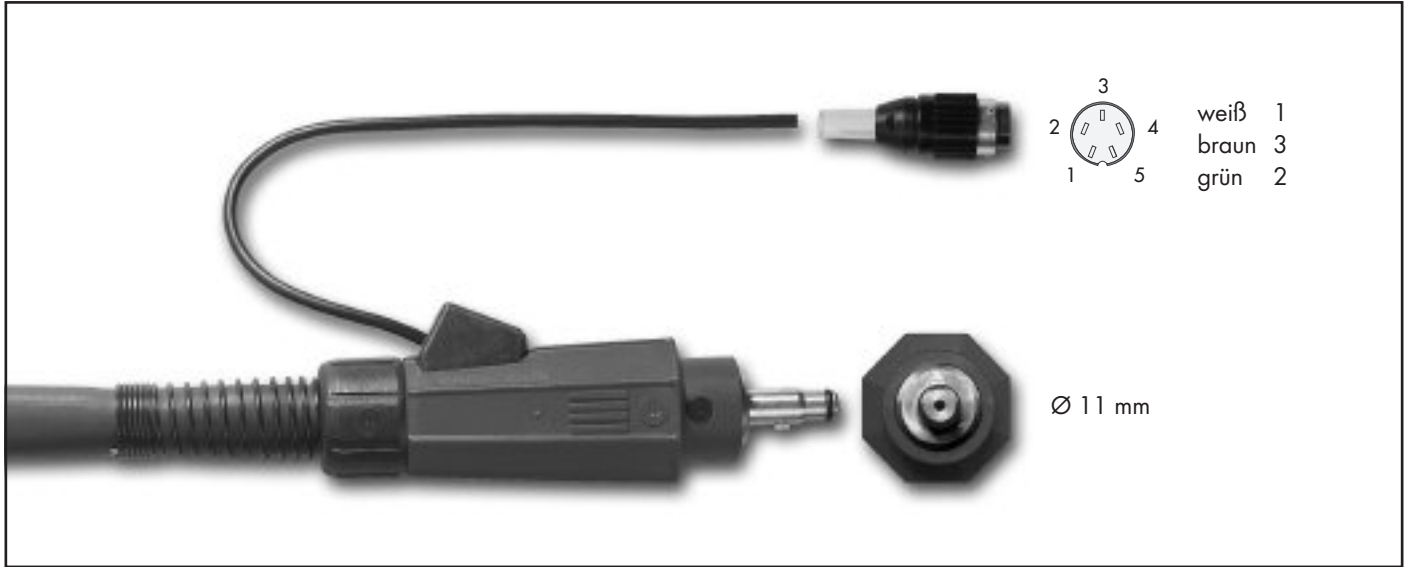

Brennertyp	Länge	Schalterfunktion	maschinenseitiger Anschluss	Schlauchpaketausführung	Bestellnummer
ABITIG® 9	4 m	DD	dalex - BSB / CG Tuchel 5-pol.	Standard	7S1SK043102001B00
	8 m	DD	dalex - BSB / CG Tuchel 5-pol.	Standard	7S1SK083102001B00
	4 m	DD	dalex - BSB / CG Tuchel 5-pol.	High Flex Leder	7S1SH043102001B00
	8 m	DD	dalex - BSB / CG Tuchel 5-pol.	High Flex Leder	7S1SH083102001B00
ABITIG® 9F	4 m	DD	dalex - BSB / CG Tuchel 5-pol.	Standard	7S1FK043102001B00
	8 m	DD	dalex - BSB / CG Tuchel 5-pol.	Standard	7S1FK083102001B00
	4 m	DD	dalex - BSB / CG Tuchel 5-pol.	High Flex Leder	7S1FH043102001B00
	8 m	DD	dalex - BSB / CG Tuchel 5-pol.	High Flex Leder	7S1FH083102001B00
ABITIG® 17	4 m	DD	dalex - BSB / CG Tuchel 5-pol.	Standard	7S2SK043102001B00
	8 m	DD	dalex - BSB / CG Tuchel 5-pol.	Standard	7S2SK083102001B00
	4 m	DD	dalex - BSB / CG Tuchel 5-pol.	High Flex Leder	7S2SH043102001B00
	8 m	DD	dalex - BSB / CG Tuchel 5-pol.	High Flex Leder	7S2SH083102001B00
ABITIG® 17F	4 m	DD	dalex - BSB / CG Tuchel 5-pol.	Standard	7S2FK043102001B00
	8 m	DD	dalex - BSB / CG Tuchel 5-pol.	Standard	7S2FK083102001B00
	4 m	DD	dalex - BSB / CG Tuchel 5-pol.	High Flex Leder	7S2FH043102001B00
	8 m	DD	dalex - BSB / CG Tuchel 5-pol.	High Flex Leder	7S2FH083102001B00

Technische Änderungen vorbehalten • Verkaufspreise = unverbindliche Preisempfehlung - Angebot freibleibend • © Copyright

ABITIG®-Brennerpreisliste

passend für WIG-Stromquellen des Fabrikates „dalex“

Brennertyp	Länge	Schalterfunktion	maschinenseitiger Anschluss	Schlauchpaketausführung	Bestellnummer
ABITIG® 26	4 m	DD	dalex - BSB / CG Tuchel 5-pol.	Standard	7S3SK043102001B00
	8 m	DD	dalex - BSB / CG Tuchel 5-pol.	Standard	7S3SK083102001B00
	4 m	DD	dalex - BSB / CG Tuchel 5-pol.	High Flex Leder	7S3SH043102001B00
	8 m	DD	dalex - BSB / CG Tuchel 5-pol.	High Flex Leder	7S3SH083102001B00
<hr/>					
ABITIG® 26F	4 m	DD	dalex - BSB / CG Tuchel 5-pol.	Standard	7S3FK043102001B00
	8 m	DD	dalex - BSB / CG Tuchel 5-pol.	Standard	7S3FK083102001B00
	4 m	DD	dalex - BSB / CG Tuchel 5-pol.	High Flex Leder	7S3FH043102001B00
	8 m	DD	dalex - BSB / CG Tuchel 5-pol.	High Flex Leder	7S3FH083102001B00
<hr/>					
ABITIG® 24G	4 m	DD	dalex - BSB / CG Tuchel 5-pol.	Standard	7S8SK043102001B00
	8 m	DD	dalex - BSB / CG Tuchel 5-pol.	Standard	7S8SK083102001B00
	4 m	DD	dalex - BSB / CG Tuchel 5-pol.	High Flex Leder	7S8SH043102001B00
	8 m	DD	dalex - BSB / CG Tuchel 5-pol.	High Flex Leder	7S8SH083102001B00
<hr/>					
ABITIG® 200	4 m	DD	dalex - BSB / CG Tuchel 5-pol.	Standard	7T4SK043102001B00
	8 m	DD	dalex - BSB / CG Tuchel 5-pol.	Standard	7T4SK083102001B00
	4 m	DD	dalex - BSB / CG Tuchel 5-pol.	High Flex Leder	7T4SH043102001B00
	8 m	DD	dalex - BSB / CG Tuchel 5-pol.	High Flex Leder	7T4SH083102001B00
<hr/>					
ABITIG® 200F	4 m	DD	dalex - BSB / CG Tuchel 5-pol.	Standard	7T4FK043102001B00
	8 m	DD	dalex - BSB / CG Tuchel 5-pol.	Standard	7T4FK083102001B00
	4 m	DD	dalex - BSB / CG Tuchel 5-pol.	High Flex Leder	7T4FH043102001B00
	8 m	DD	dalex - BSB / CG Tuchel 5-pol.	High Flex Leder	7T4FH083102001B00
<hr/>					
ABITIG® 150	4 m	DD	dalex - BSB / CG Tuchel 5-pol.	Standard	7T6SK043102001B00
	8 m	DD	dalex - BSB / CG Tuchel 5-pol.	Standard	7T6SK083102001B00
	4 m	DD	dalex - BSB / CG Tuchel 5-pol.	High Flex Leder	7T6SH043102001B00
	8 m	DD	dalex - BSB / CG Tuchel 5-pol.	High Flex Leder	7T6SH083102001B00
<hr/>					
ABITIG® 150F	4 m	DD	dalex - BSB / CG Tuchel 5-pol.	Standard	7T6FK043102001B00
	8 m	DD	dalex - BSB / CG Tuchel 5-pol.	Standard	7T6FK083102001B00
	4 m	DD	dalex - BSB / CG Tuchel 5-pol.	High Flex Leder	7T6FH043102001B00
	8 m	DD	dalex - BSB / CG Tuchel 5-pol.	High Flex Leder	7T6FH083102001B00

ABITIG®-Brennerpreisliste

passend für WIG-Stromquellen des Fabrikates „dalex“



Brennertyp	Länge	Schalterfunktion	maschinenseitiger Anschluss	Schlauchpaketausführung	Bestellnummer
ABITIG® 9	4 m	DDP	dalex - BSB / CG Tuchel 5-pol. + Tuchel 7-pol.	Standard	7S1SK046042033A00
	8 m	DDP	dalex - BSB / CG Tuchel 5-pol. + Tuchel 7-pol.	Standard	7S1SK086042033A00
	4 m	DDP	dalex - BSB / CG Tuchel 5-pol. + Tuchel 7-pol.	High Flex Leder	7S1SH046042033A00
	8 m	DDP	dalex - BSB / CG Tuchel 5-pol. + Tuchel 7-pol.	High Flex Leder	7S1SH086042033A00
ABITIG® 9F	4 m	DDP	dalex - BSB / CG Tuchel 5-pol. + Tuchel 7-pol.	Standard	7S1FK046042033A00
	8 m	DDP	dalex - BSB / CG Tuchel 5-pol. + Tuchel 7-pol.	Standard	7S1FK086042033A00
	4 m	DDP	dalex - BSB / CG Tuchel 5-pol. + Tuchel 7-pol.	High Flex Leder	7S1FH046042033A00
	8 m	DDP	dalex - BSB / CG Tuchel 5-pol. + Tuchel 7-pol.	High Flex Leder	7S1FH086042033A00
ABITIG® 17	4 m	DDP	dalex - BSB / CG Tuchel 5-pol. + Tuchel 7-pol.	Standard	7S2SK046042033A00
	8 m	DDP	dalex - BSB / CG Tuchel 5-pol. + Tuchel 7-pol.	Standard	7S2SK086042033A00
	4 m	DDP	dalex - BSB / CG Tuchel 5-pol. + Tuchel 7-pol.	High Flex Leder	7S2SH046042033A00
	8 m	DDP	dalex - BSB / CG Tuchel 5-pol. + Tuchel 7-pol.	High Flex Leder	7S2SH086042033A00
ABITIG® 17F	4 m	DDP	dalex - BSB / CG Tuchel 5-pol. + Tuchel 7-pol.	Standard	7S2FK046042033A00
	8 m	DDP	dalex - BSB / CG Tuchel 5-pol. + Tuchel 7-pol.	Standard	7S2FK086042033A00
	4 m	DDP	dalex - BSB / CG Tuchel 5-pol. + Tuchel 7-pol.	High Flex Leder	7S2FH046042033A00
	8 m	DDP	dalex - BSB / CG Tuchel 5-pol. + Tuchel 7-pol.	High Flex Leder	7S2FH086042033A00

Technische Änderungen vorbehalten • Verkaufspreise = unverbindliche Preisempfehlung - Angebot freibleibend • © Copyright

ABITIG®-Brennerpreisliste

passend für WIG-Stromquellen des Fabrikates „dalex“

Brennertyp	Länge	Schalterfunktion	maschinenseitiger Anschluss	Schlauchpaketausführung	Bestellnummer
ABITIG® 26	4 m	DDP	dalex - BSB / CG Tuchel 5-pol. + Tuchel 7-pol.	Standard	7S3SK046042033A00
	8 m	DDP	dalex - BSB / CG Tuchel 5-pol. + Tuchel 7-pol.	Standard	7S3SK086042033A00
	4 m	DDP	dalex - BSB / CG Tuchel 5-pol. + Tuchel 7-pol.	High Flex Leder	7S3SH046042033A00
	8 m	DDP	dalex - BSB / CG Tuchel 5-pol. + Tuchel 7-pol.	High Flex Leder	7S3SH086042033A00
ABITIG® 26F	4 m	DDP	dalex - BSB / CG Tuchel 5-pol. + Tuchel 7-pol.	Standard	7S3FK046042033A00
	8 m	DDP	dalex - BSB / CG Tuchel 5-pol. + Tuchel 7-pol.	Standard	7S3FK086042033A00
	4 m	DDP	dalex - BSB / CG Tuchel 5-pol. + Tuchel 7-pol.	High Flex Leder	7S3FH046042033A00
	8 m	DDP	dalex - BSB / CG Tuchel 5-pol. + Tuchel 7-pol.	High Flex Leder	7S3FH086042033A00
ABITIG® 24G	4 m	DDP	dalex - BSB / CG Tuchel 5-pol. + Tuchel 7-pol.	Standard	7S8SK046042033A00
	8 m	DDP	dalex - BSB / CG Tuchel 5-pol. + Tuchel 7-pol.	Standard	7S8SK086042033A00
	4 m	DDP	dalex - BSB / CG Tuchel 5-pol. + Tuchel 7-pol.	High Flex Leder	7S8SH046042033A00
	8 m	DDP	dalex - BSB / CG Tuchel 5-pol. + Tuchel 7-pol.	High Flex Leder	7S8SH086042033A00
ABITIG® 200	4 m	DDP	dalex - BSB / CG Tuchel 5-pol. + Tuchel 7-pol.	Standard	7T4SK046042033A00
	8 m	DDP	dalex - BSB / CG Tuchel 5-pol. + Tuchel 7-pol.	Standard	7T4SK086042033A00
	4 m	DDP	dalex - BSB / CG Tuchel 5-pol. + Tuchel 7-pol.	High Flex Leder	7T4SH046042033A00
	8 m	DDP	dalex - BSB / CG Tuchel 5-pol. + Tuchel 7-pol.	High Flex Leder	7T4SH086042033A00
ABITIG® 200F	4 m	DDP	dalex - BSB / CG Tuchel 5-pol. + Tuchel 7-pol.	Standard	7T4FK046042033A00
	8 m	DDP	dalex - BSB / CG Tuchel 5-pol. + Tuchel 7-pol.	Standard	7T4FK086042033A00
	4 m	DDP	dalex - BSB / CG Tuchel 5-pol. + Tuchel 7-pol.	High Flex Leder	7T4FH046042033A00
	8 m	DDP	dalex - BSB / CG Tuchel 5-pol. + Tuchel 7-pol.	High Flex Leder	7T4FH086042033A00
ABITIG® 150	4 m	DDP	dalex - BSB / CG Tuchel 5-pol. + Tuchel 7-pol.	Standard	7T6SK046042033A00
	8 m	DDP	dalex - BSB / CG Tuchel 5-pol. + Tuchel 7-pol.	Standard	7T6SK086042033A00
	4 m	DDP	dalex - BSB / CG Tuchel 5-pol. + Tuchel 7-pol.	High Flex Leder	7T6SH046042033A00
	8 m	DDP	dalex - BSB / CG Tuchel 5-pol. + Tuchel 7-pol.	High Flex Leder	7T6SH086042033A00
ABITIG® 150F	4 m	DDP	dalex - BSB / CG Tuchel 5-pol. + Tuchel 7-pol.	Standard	7T6FK046042033A00
	8 m	DDP	dalex - BSB / CG Tuchel 5-pol. + Tuchel 7-pol.	Standard	7T6FK086042033A00
	4 m	DDP	dalex - BSB / CG Tuchel 5-pol. + Tuchel 7-pol.	High Flex Leder	7T6FH046042033A00
	8 m	DDP	dalex - BSB / CG Tuchel 5-pol. + Tuchel 7-pol.	High Flex Leder	7T6FH086042033A00

ABITIG®-Brennerpreisliste

passend für WIG-Stromquellen des Fabrikates „dalex“

Für dieses Gerätefabrikat ist in der Bestellnummer und somit auch im Lieferumfang das Ansteuermodul BIS-10 enthalten. Das Ansteuermodul BIS-10 enthält im Gegensatz zu BIS-02 die verstärkte Schalterausführung (2x) wegen der geräteabhängigen höheren Schaltströme.



Brennertyp	Länge	Schalterfunktion	maschinenseitiger Anschluss	Schlauchpaketausführung	Bestellnummer
ABITIG® 9	4 m	ED	EA Tuchel 3-pol.	Standard	7S1SK043100920A00
	8 m	ED	EA Tuchel 3-pol.	Standard	7S1SK083100920A00
	4 m	ED	EA Tuchel 3-pol.	High Flex Leder	7S1SH043100920A00
	8 m	ED	EA Tuchel 3-pol.	High Flex Leder	7S1SH083100920A00
ABITIG® 9F	4 m	ED	EA Tuchel 3-pol.	Standard	7S1FK043100920A00
	8 m	ED	EA Tuchel 3-pol.	Standard	7S1FK083100920A00
	4 m	ED	EA Tuchel 3-pol.	High Flex Leder	7S1FH043100920A00
	8 m	ED	EA Tuchel 3-pol.	High Flex Leder	7S1FH083100920A00
ABITIG® 17	4 m	ED	EA Tuchel 3-pol.	Standard	7S2SK043100920A00
	8 m	ED	EA Tuchel 3-pol.	Standard	7S2SK083100920A00
	4 m	ED	EA Tuchel 3-pol.	High Flex Leder	7S2SH043100920A00
	8 m	ED	EA Tuchel 3-pol.	High Flex Leder	7S2SH083100920A00
ABITIG® 17F	4 m	ED	EA Tuchel 3-pol.	Standard	7S2FK043100920A00
	8 m	ED	EA Tuchel 3-pol.	Standard	7S2FK083100920A00
	4 m	ED	EA Tuchel 3-pol.	High Flex Leder	7S2FH043100920A00
	8 m	ED	EA Tuchel 3-pol.	High Flex Leder	7S2FH083100920A00

Technische Änderungen vorbehalten • Verkaufspreise = unverbindliche Preisempfehlung - Angebot freibleibend • © Copyright

ABITIG®-Brennerpreisliste

passend für WIG-Stromquellen des Fabrikates „dalex“

Brennertyp	Länge	Schalterfunktion	maschinenseitiger Anschluss	Schlauchpaketausführung	Bestellnummer
ABITIG® 26	4 m	ED	EA Tuchel 3-pol.	Standard	7S3SK043100920A00
	8 m	ED	EA Tuchel 3-pol.	Standard	7S3SK083100920A00
	4 m	ED	EA Tuchel 3-pol.	High Flex Leder	7S3SH043100920A00
	8 m	ED	EA Tuchel 3-pol.	High Flex Leder	7S3SH083100920A00
ABITIG® 26F	4 m	ED	EA Tuchel 3-pol.	Standard	7S3FK043100920A00
	8 m	ED	EA Tuchel 3-pol.	Standard	7S3FK083100920A00
	4 m	ED	EA Tuchel 3-pol.	High Flex Leder	7S3FH043100920A00
	8 m	ED	EA Tuchel 3-pol.	High Flex Leder	7S3FH083100920A00
ABITIG® 24G	4 m	ED	EA Tuchel 3-pol.	Standard	7S8SK043100920A00
	8 m	ED	EA Tuchel 3-pol.	Standard	7S8SK083100920A00
	4 m	ED	EA Tuchel 3-pol.	High Flex Leder	7S8SH043100920A00
	8 m	ED	EA Tuchel 3-pol.	High Flex Leder	7S8SH083100920A00
ABITIG® 200	4 m	ED	EA Tuchel 3-pol.	Standard	7T4SK043100920A00
	8 m	ED	EA Tuchel 3-pol.	Standard	7T4SK083100920A00
	4 m	ED	EA Tuchel 3-pol.	High Flex Leder	7T4SH043100920A00
	8 m	ED	EA Tuchel 3-pol.	High Flex Leder	7T4SH083100920A00
ABITIG® 200F	4 m	ED	EA Tuchel 3-pol.	Standard	7T4FK043100920A00
	8 m	ED	EA Tuchel 3-pol.	Standard	7T4FK083100920A00
	4 m	ED	EA Tuchel 3-pol.	High Flex Leder	7T4FH043100920A00
	8 m	ED	EA Tuchel 3-pol.	High Flex Leder	7T4FH083100920A00
ABITIG® 150	4 m	ED	EA Tuchel 3-pol.	Standard	7T6SK043100920A00
	8 m	ED	EA Tuchel 3-pol.	Standard	7T6SK083100920A00
	4 m	ED	EA Tuchel 3-pol.	High Flex Leder	7T6SH043100920A00
	8 m	ED	EA Tuchel 3-pol.	High Flex Leder	7T6SH083100920A00
ABITIG® 150F	4 m	ED	EA Tuchel 3-pol.	Standard	7T6FK043100920A00
	8 m	ED	EA Tuchel 3-pol.	Standard	7T6FK083100920A00
	4 m	ED	EA Tuchel 3-pol.	High Flex Leder	7T6FH043100920A00
	8 m	ED	EA Tuchel 3-pol.	High Flex Leder	7T6FH083100920A00

ABITIG®-Brennerpreisliste

passend für WIG-Stromquellen des Fabrikates „dalex“

Für dieses Gerätefabrikat ist in der Bestellnummer und somit auch im Lieferumfang das Ansteuermodul BIS-10 enthalten. Das Ansteuermodul BIS-10 enthält im Gegensatz zu BIS-02 die verstärkte Schalterausführung (2x) wegen der geräteabhängigen höheren Schaltströme.

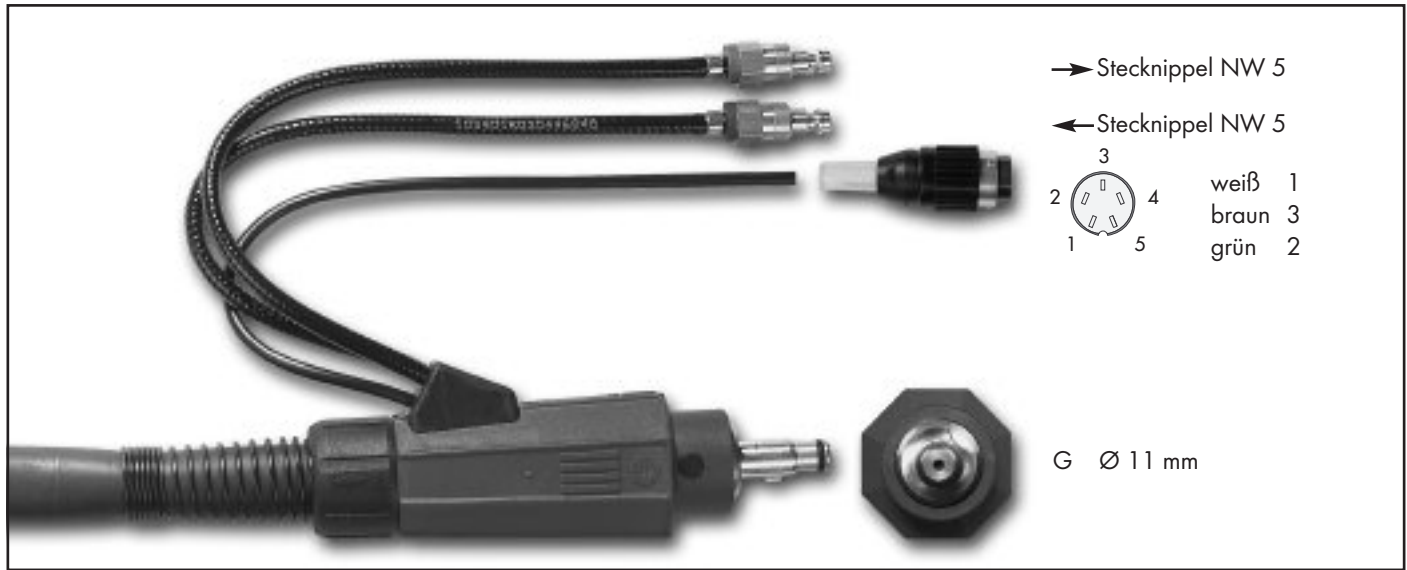

Brennertyp	Länge	Schalterfunktion	maschinenseitiger Anschluss	Schlauchpaketausführung	Bestellnummer
ABITIG® 18	4 m	DD	dalex - BSB / CG Tuchel 5-pol.	Standard	7S4SK043102001B18
	8 m	DD	dalex - BSB / CG Tuchel 5-pol.	Standard	7S4SK083102001B18
	4 m	DD	dalex - BSB / CG Tuchel 5-pol.	High Flex Leder	7S4SH043102001B18
	8 m	DD	dalex - BSB / CG Tuchel 5-pol.	High Flex Leder	7S4SH083102001B18
ABITIG® 18F	4 m	DD	dalex - BSB / CG Tuchel 5-pol.	Standard	7S4FK043102001B18
	8 m	DD	dalex - BSB / CG Tuchel 5-pol.	Standard	7S4FK083102001B18
	4 m	DD	dalex - BSB / CG Tuchel 5-pol.	High Flex Leder	7S4FH043102001B18
	8 m	DD	dalex - BSB / CG Tuchel 5-pol.	High Flex Leder	7S4FH083102001B18
ABITIG® 20	4 m	DD	dalex - BSB / CG Tuchel 5-pol.	Standard	7S5SK043102001B18
	8 m	DD	dalex - BSB / CG Tuchel 5-pol.	Standard	7S5SK083102001B18
	4 m	DD	dalex - BSB / CG Tuchel 5-pol.	High Flex Leder	7S5SH043102001B18
	8 m	DD	dalex - BSB / CG Tuchel 5-pol.	High Flex Leder	7S5SH083102001B18
ABITIG® 20F	4 m	DD	dalex - BSB / CG Tuchel 5-pol.	Standard	7S5FK043102001B18
	8 m	DD	dalex - BSB / CG Tuchel 5-pol.	Standard	7S5FK083102001B18
	4 m	DD	dalex - BSB / CG Tuchel 5-pol.	High Flex Leder	7S5FH043102001B18
	8 m	DD	dalex - BSB / CG Tuchel 5-pol.	High Flex Leder	7S5FH083102001B18

Technische Änderungen vorbehalten • Verkaufspreise = unverbindliche Preisempfehlung - Angebot freibleibend • © Copyright

ABITIG®-Brennerpreisliste

passend für WIG-Stromquellen des Fabrikates „dalex“

Brennertyp	Länge	Schalterfunktion	maschinenseitiger Anschluss	Schlauchpaketausführung	Bestellnummer
ABITIG® 12-1	4 m	DD	dalex - BSB / CG Tuchel 5-pol.	Standard	7S6SK043102001B18
	8 m	DD	dalex - BSB / CG Tuchel 5-pol.	Standard	7S6SK083102001B18
	4 m	DD	dalex - BSB / CG Tuchel 5-pol.	High Flex Leder	7S6SH043102001B18
	8 m	DD	dalex - BSB / CG Tuchel 5-pol.	High Flex Leder	7S6SH083102001B18
ABITIG® 18SC	4 m	DD	dalex - BSB / CG Tuchel 5-pol.	Standard	7S7SK043102001B18
	8 m	DD	dalex - BSB / CG Tuchel 5-pol.	Standard	7S7SK083102001B18
	4 m	DD	dalex - BSB / CG Tuchel 5-pol.	High Flex Leder	7S7SH043102001B18
	8 m	DD	dalex - BSB / CG Tuchel 5-pol.	High Flex Leder	7S7SH083102001B18
ABITIG® 24W	4 m	DD	dalex - BSB / CG Tuchel 5-pol.	Standard	7S9SK043102001B18
	8 m	DD	dalex - BSB / CG Tuchel 5-pol.	Standard	7S9SK083102001B18
	4 m	DD	dalex - BSB / CG Tuchel 5-pol.	High Flex Leder	7S9SH043102001B18
	8 m	DD	dalex - BSB / CG Tuchel 5-pol.	High Flex Leder	7S9SH083102001B18
ABITIG® 450W	4 m	DD	dalex - BSB / CG Tuchel 5-pol.	Standard	7T5SK043102001B18
	8 m	DD	dalex - BSB / CG Tuchel 5-pol.	Standard	7T5SK083102001B18
	4 m	DD	dalex - BSB / CG Tuchel 5-pol.	High Flex Leder	7T5SH043102001B18
	8 m	DD	dalex - BSB / CG Tuchel 5-pol.	High Flex Leder	7T5SH083102001B18
ABITIG® 260W	4 m	DD	dalex - BSB / CG Tuchel 5-pol.	Standard	7T7SK043102001B18
	8 m	DD	dalex - BSB / CG Tuchel 5-pol.	Standard	7T7SK083102001B18
	4 m	DD	dalex - BSB / CG Tuchel 5-pol.	High Flex Leder	7T7SH043102001B18
	8 m	DD	dalex - BSB / CG Tuchel 5-pol.	High Flex Leder	7T7SH083102001B18
ABITIG® 450W SC	4 m	DD	dalex - BSB / CG Tuchel 5-pol.	Standard	
	8 m	DD	dalex - BSB / CG Tuchel 5-pol.	Standard	
	4 m	DD	dalex - BSB / CG Tuchel 5-pol.	High Flex Leder	7T8SH043102001B18
	8 m	DD	dalex - BSB / CG Tuchel 5-pol.	High Flex Leder	7T8SH083102001B18

ABITIG®-Brennerpreisliste

passend für WIG-Stromquellen des Fabrikates „dalex“

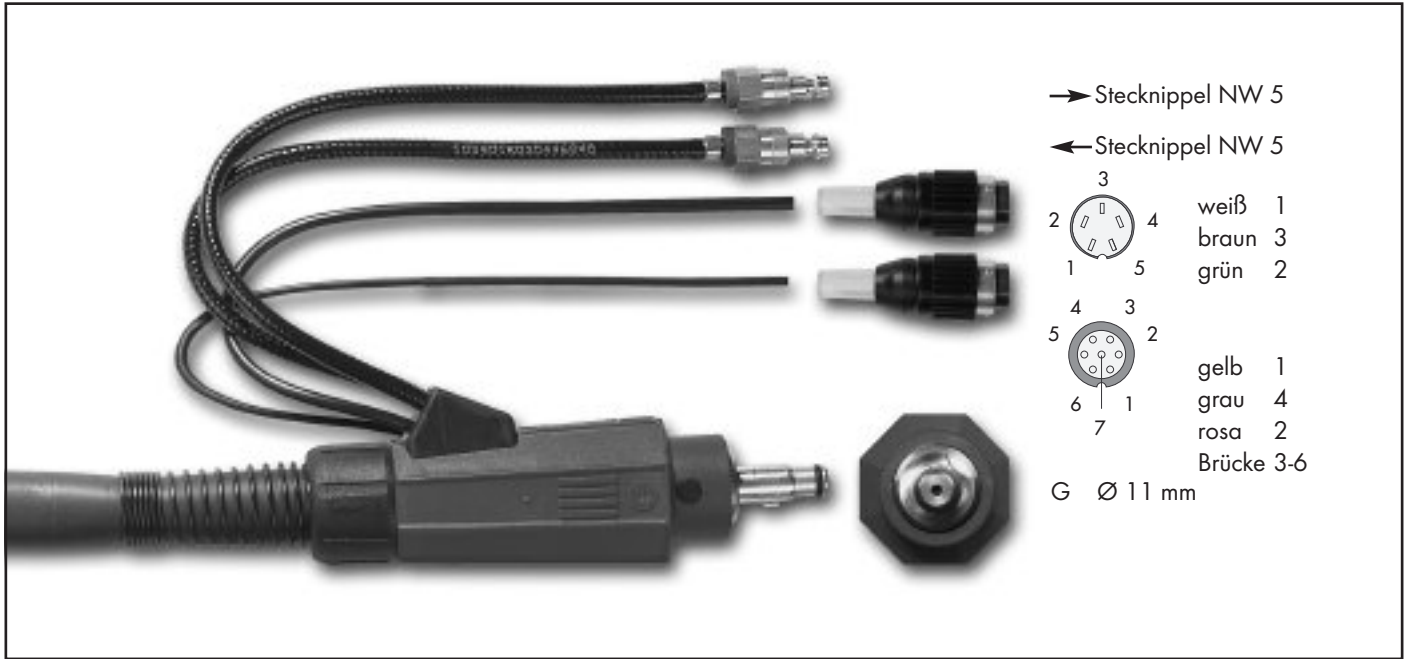

Brennertyp	Länge	Schalterfunktion	maschinenseitiger Anschluss	Schlauchpaketausführung	Bestellnummer
ABITIG® 18	4 m	DDP	dalex - BSB / CG Tuchel 5-pol. + Tuchel 7-pol.	Standard	7S4SK046042033A18
	8 m	DDP	dalex - BSB / CG Tuchel 5-pol. + Tuchel 7-pol.	Standard	7S4SK086042033A18
	4 m	DDP	dalex - BSB / CG Tuchel 5-pol. + Tuchel 7-pol.	High Flex Leder	7S4SH046042033A18
	8 m	DDP	dalex - BSB / CG Tuchel 5-pol. + Tuchel 7-pol.	High Flex Leder	7S4SH086042033A18
ABITIG® 18F	4 m	DDP	dalex - BSB / CG Tuchel 5-pol. + Tuchel 7-pol.	Standard	7S4FK046042033A18
	8 m	DDP	dalex - BSB / CG Tuchel 5-pol. + Tuchel 7-pol.	Standard	7S4FK086042033A18
	4 m	DDP	dalex - BSB / CG Tuchel 5-pol. + Tuchel 7-pol.	High Flex Leder	7S4FH046042033A18
	8 m	DDP	dalex - BSB / CG Tuchel 5-pol. + Tuchel 7-pol.	High Flex Leder	7S4FH086042033A18
ABITIG® 20	4 m	DDP	dalex - BSB / CG Tuchel 5-pol. + Tuchel 7-pol.	Standard	7S5SK046042033A18
	8 m	DDP	dalex - BSB / CG Tuchel 5-pol. + Tuchel 7-pol.	Standard	7S5SK086042033A18
	4 m	DDP	dalex - BSB / CG Tuchel 5-pol. + Tuchel 7-pol.	High Flex Leder	7S5SH046042033A18
	8 m	DDP	dalex - BSB / CG Tuchel 5-pol. + Tuchel 7-pol.	High Flex Leder	7S5SH086042033A18
ABITIG® 20F	4 m	DDP	dalex - BSB / CG Tuchel 5-pol. + Tuchel 7-pol.	Standard	7S5FK046042033A18
	8 m	DDP	dalex - BSB / CG Tuchel 5-pol. + Tuchel 7-pol.	Standard	7S5FK086042033A18
	4 m	DDP	dalex - BSB / CG Tuchel 5-pol. + Tuchel 7-pol.	High Flex Leder	7S5FH046042033A18
	8 m	DDP	dalex - BSB / CG Tuchel 5-pol. + Tuchel 7-pol.	High Flex Leder	7S5FH086042033A18

Technische Änderungen vorbehalten • Verkaufspreise = unverbindliche Preisempfehlung - Angebot freibleibend • © Copyright

ABITIG®-Brennerpreisliste

passend für WIG-Stromquellen des Fabrikates „dalex“

Brennertyp	Länge	Schalterfunktion	maschinenseitiger Anschluss	Schlauchpaketausführung	Bestellnummer
ABITIG® 12-1	4 m	DDP	dalex - BSB / CG Tuchel 5-pol. + Tuchel 7-pol.	Standard	7S6SK046042033A18
	8 m	DDP	dalex - BSB / CG Tuchel 5-pol. + Tuchel 7-pol.	Standard	7S6SK086042033A18
	4 m	DDP	dalex - BSB / CG Tuchel 5-pol. + Tuchel 7-pol.	High Flex Leder	7S6SH046042033A18
	8 m	DDP	dalex - BSB / CG Tuchel 5-pol. + Tuchel 7-pol.	High Flex Leder	7S6SH086042033A18
ABITIG® 18SC	4 m	DDP	dalex - BSB / CG Tuchel 5-pol. + Tuchel 7-pol.	Standard	7S7SK046042033A18
	8 m	DDP	dalex - BSB / CG Tuchel 5-pol. + Tuchel 7-pol.	Standard	7S7SK086042033A18
	4 m	DDP	dalex - BSB / CG Tuchel 5-pol. + Tuchel 7-pol.	High Flex Leder	7S7SH046042033A18
	8 m	DDP	dalex - BSB / CG Tuchel 5-pol. + Tuchel 7-pol.	High Flex Leder	7S7SH086042033A18
ABITIG® 24W	4 m	DDP	dalex - BSB / CG Tuchel 5-pol. + Tuchel 7-pol.	Standard	7S9SK046042033A18
	8 m	DDP	dalex - BSB / CG Tuchel 5-pol. + Tuchel 7-pol.	Standard	7S9SK086042033A18
	4 m	DDP	dalex - BSB / CG Tuchel 5-pol. + Tuchel 7-pol.	High Flex Leder	7S9SH046042033A18
	8 m	DDP	dalex - BSB / CG Tuchel 5-pol. + Tuchel 7-pol.	High Flex Leder	7S9SH086042033A18
ABITIG® 450W	4 m	DDP	dalex - BSB / CG Tuchel 5-pol. + Tuchel 7-pol.	Standard	7T5SK046042033A18
	8 m	DDP	dalex - BSB / CG Tuchel 5-pol. + Tuchel 7-pol.	Standard	7T5SK086042033A18
	4 m	DDP	dalex - BSB / CG Tuchel 5-pol. + Tuchel 7-pol.	High Flex Leder	7T5SH046042033A18
	8 m	DDP	dalex - BSB / CG Tuchel 5-pol. + Tuchel 7-pol.	High Flex Leder	7T5SH086042033A18
ABITIG® 260W	4 m	DDP	dalex - BSB / CG Tuchel 5-pol. + Tuchel 7-pol.	Standard	7T7SK046042033A18
	8 m	DDP	dalex - BSB / CG Tuchel 5-pol. + Tuchel 7-pol.	Standard	7T7SK086042033A18
	4 m	DDP	dalex - BSB / CG Tuchel 5-pol. + Tuchel 7-pol.	High Flex Leder	7T7SH046042033A18
	8 m	DDP	dalex - BSB / CG Tuchel 5-pol. + Tuchel 7-pol.	High Flex Leder	7T7SH086042033A18
ABITIG® 450W SC	4 m	DDP	dalex - BSB / CG Tuchel 5-pol. + Tuchel 7-pol.	Standard	
	8 m	DDP	dalex - BSB / CG Tuchel 5-pol. + Tuchel 7-pol.	Standard	
	4 m	DDP	dalex - BSB / CG Tuchel 5-pol. + Tuchel 7-pol.	High Flex Leder	7T8SH046042033A18
	8 m	DDP	dalex - BSB / CG Tuchel 5-pol. + Tuchel 7-pol.	High Flex Leder	7T8SH086042033A18

ABITIG®-Brennerpreisliste

passend für WIG-Stromquellen des Fabrikates „dalex“

Für dieses Gerätefabrikat ist in der Bestellnummer und somit auch im Lieferumfang das Ansteuermodul BIS-10 enthalten. Das Ansteuermodul BIS-10 enthält im Gegensatz zu BIS-02 die verstärkte Schalterausführung (2x) wegen der geräteabhängigen höheren Schaltströme.



Brennertyp	Länge	Schalterfunktion	maschinenseitiger Anschluss	Schlauchpaketausführung	Bestellnummer
ABITIG® 18	4 m	ED	EA Tuchel 3-pol.	Standard	7S4SK043100813A15
	8 m	ED	EA Tuchel 3-pol.	Standard	7S4SK083100813A15
	4 m	ED	EA Tuchel 3-pol.	High Flex Leder	7S4SH043100813A15
	8 m	ED	EA Tuchel 3-pol.	High Flex Leder	7S4SH083100813A15
ABITIG® 18F	4 m	ED	EA Tuchel 3-pol.	Standard	7S4FK043100813A15
	8 m	ED	EA Tuchel 3-pol.	Standard	7S4FK083100813A15
	4 m	ED	EA Tuchel 3-pol.	High Flex Leder	7S4FH043100813A15
	8 m	ED	EA Tuchel 3-pol.	High Flex Leder	7S4FH083100813A15
ABITIG® 20	4 m	ED	EA Tuchel 3-pol.	Standard	7S5SK043100813A15
	8 m	ED	EA Tuchel 3-pol.	Standard	7S5SK083100813A15
	4 m	ED	EA Tuchel 3-pol.	High Flex Leder	7S5SH043100813A15
	8 m	ED	EA Tuchel 3-pol.	High Flex Leder	7S5SH083100813A15
ABITIG® 20F	4 m	ED	EA Tuchel 3-pol.	Standard	7S5FK043100813A15
	8 m	ED	EA Tuchel 3-pol.	Standard	7S5FK083100813A15
	4 m	ED	EA Tuchel 3-pol.	High Flex Leder	7S5FH043100813A15
	8 m	ED	EA Tuchel 3-pol.	High Flex Leder	7S5FH083100813A15

ABITIG®-Brennerpreisliste

passend für WIG-Stromquellen des Fabrikates „dalex“

Brennertyp	Länge	Schalterfunktion	maschinenseitiger Anschluss	Schlauchpaketausführung	Bestellnummer
ABITIG® 12-1	4 m	ED	EA Tuchel 3-pol.	Standard	7S6SK043100813A15
	8 m	ED	EA Tuchel 3-pol.	Standard	7S6SK083100813A15
	4 m	ED	EA Tuchel 3-pol.	High Flex Leder	7S6SH043100813A15
	8 m	ED	EA Tuchel 3-pol.	High Flex Leder	7S6SH083100813A15
ABITIG® 18SC	4 m	ED	EA Tuchel 3-pol.	Standard	7S7SK043100813A15
	8 m	ED	EA Tuchel 3-pol.	Standard	7S7SK083100813A15
	4 m	ED	EA Tuchel 3-pol.	High Flex Leder	7S7SH043100813A15
	8 m	ED	EA Tuchel 3-pol.	High Flex Leder	7S7SH083100813A15
ABITIG® 24W	4 m	ED	EA Tuchel 3-pol.	Standard	7S9SK043100813A15
	8 m	ED	EA Tuchel 3-pol.	Standard	7S9SK083100813A15
	4 m	ED	EA Tuchel 3-pol.	High Flex Leder	7S9SH043100813A15
	8 m	ED	EA Tuchel 3-pol.	High Flex Leder	7S9SH083100813A15
ABITIG® 450W	4 m	ED	EA Tuchel 3-pol.	Standard	7T5SK043100813A15
	8 m	ED	EA Tuchel 3-pol.	Standard	7T5SK083100813A15
	4 m	ED	EA Tuchel 3-pol.	High Flex Leder	7T5SH043100813A15
	8 m	ED	EA Tuchel 3-pol.	High Flex Leder	7T5SH083100813A15
ABITIG® 260W	4 m	ED	EA Tuchel 3-pol.	Standard	7T7SK043100813A15
	8 m	ED	EA Tuchel 3-pol.	Standard	7T7SK083100813A15
	4 m	ED	EA Tuchel 3-pol.	High Flex Leder	7T7SH043100813A15
	8 m	ED	EA Tuchel 3-pol.	High Flex Leder	7T7SH083100813A15
ABITIG® 450W SC	4 m	ED	EA Tuchel 3-pol.	Standard	
	8 m	ED	EA Tuchel 3-pol.	Standard	
	4 m	ED	EA Tuchel 3-pol.	High Flex Leder	7T8SH043100813A15
	8 m	ED	EA Tuchel 3-pol.	High Flex Leder	7T8SH083100813A15

ABITIG®-Brennerpreisliste

passend für WIG-Stromquellen des Fabrikates „elekra-beckum“



Brennertyp	Länge	Schalterfunktion	maschinenseitiger Anschluss	Schlauchpaketausführung	Bestellnummer
ABITIG® 9	4 m	DD	BSB 10-25 Stecker 7-pol.	Standard	7S1SK043022217A06
	8 m	DD	BSB 10-25 Stecker 7-pol.	Standard	7S1SK083022217A06
	4 m	DD	BSB 10-25 Stecker 7-pol.	High Flex Leder	7S1SH043022217A06
	8 m	DD	BSB 10-25 Stecker 7-pol.	High Flex Leder	7S1SH083022217A06

ABITIG® 9F	4 m	DD	BSB 10-25 Stecker 7-pol.	Standard	7S1FK043022217A06
	8 m	DD	BSB 10-25 Stecker 7-pol.	Standard	7S1FK083022217A06
	4 m	DD	BSB 10-25 Stecker 7-pol.	High Flex Leder	7S1FH043022217A06
	8 m	DD	BSB 10-25 Stecker 7-pol.	High Flex Leder	7S1FH083022217A06

ABITIG® 17	4 m	DD	BSB 10-25 Stecker 7-pol.	Standard	7S2SK043022217A06
	8 m	DD	BSB 10-25 Stecker 7-pol.	Standard	7S2SK083022217A06
	4 m	DD	BSB 10-25 Stecker 7-pol.	High Flex Leder	7S2SH043022217A06
	8 m	DD	BSB 10-25 Stecker 7-pol.	High Flex Leder	7S2SH083022217A06

ABITIG® 17F	4 m	DD	BSB 10-25 Stecker 7-pol.	Standard	7S2FK043022217A06
	8 m	DD	BSB 10-25 Stecker 7-pol.	Standard	7S2FK083022217A06
	4 m	DD	BSB 10-25 Stecker 7-pol.	High Flex Leder	7S2FH043022217A06
	8 m	DD	BSB 10-25 Stecker 7-pol.	High Flex Leder	7S2FH083022217A06

Technische Änderungen vorbehalten • Verkaufspreise = unverbindliche Preisempfehlung - Angebot freibleibend • © Copyright

ABITIG®-Brennerpreisliste

passend für WIG-Stromquellen des Fabrikates „**elektra-beckum**“

Brennertyp	Länge	Schalterfunktion	maschinenseitiger Anschluss	Schlauchpaketausführung	Bestellnummer
ABITIG® 26					
ABITIG® 26F					
ABITIG® 24G	4 m	DD	BSB 10-25 Stecker 7-pol.	Standard	7S8SK043022217A06
	8 m	DD	BSB 10-25 Stecker 7-pol.	Standard	7S8SK083022217A06
	4 m	DD	BSB 10-25 Stecker 7-pol.	High Flex Leder	7S8SH043022217A06
	8 m	DD	BSB 10-25 Stecker 7-pol.	High Flex Leder	7S8SH083022217A06
ABITIG® 200					
ABITIG® 200F					
ABITIG® 150	4 m	DD	BSB 10-25 Stecker 7-pol.	Standard	7T6SK043022217A06
	8 m	DD	BSB 10-25 Stecker 7-pol.	Standard	7T6SK083022217A06
	4 m	DD	BSB 10-25 Stecker 7-pol.	High Flex Leder	7T6SH043022217A06
	8 m	DD	BSB 10-25 Stecker 7-pol.	High Flex Leder	7T6SH083022217A06
ABITIG® 150F	4 m	DD	BSB 10-25 Stecker 7-pol.	Standard	7T6FK043022217A06
	8 m	DD	BSB 10-25 Stecker 7-pol.	Standard	7T6FK083022217A06
	4 m	DD	BSB 10-25 Stecker 7-pol.	High Flex Leder	7T6FH043022217A06
	8 m	DD	BSB 10-25 Stecker 7-pol.	High Flex Leder	7T6FH083022217A06

ABITIG®-Brennerpreisliste

passend für WIG-Stromquellen des Fabrikates „elekra-beckum“



Brennertyp	Länge	Schalterfunktion	maschinenseitiger Anschluss	Schlauchpaketausführung	Bestellnummer
ABITIG® 9	4 m	DD	BSB 35-50 Stecker 7-pol.	Standard	7S1SK043020017A06
	8 m	DD	BSB 35-50 Stecker 7-pol.	Standard	7S1SK083020017A06
	4 m	DD	BSB 35-50 Stecker 7-pol.	High Flex Leder	7S1SH043020017A06
	8 m	DD	BSB 35-50 Stecker 7-pol.	High Flex Leder	7S1SH083020017A06

ABITIG® 9F	4 m	DD	BSB 35-50 Stecker 7-pol.	Standard	7S1FK043020017A06
	8 m	DD	BSB 35-50 Stecker 7-pol.	Standard	7S1FK083020017A06
	4 m	DD	BSB 35-50 Stecker 7-pol.	High Flex Leder	7S1FH043020017A06
	8 m	DD	BSB 35-50 Stecker 7-pol.	High Flex Leder	7S1FH083020017A06

ABITIG® 17	4 m	DD	BSB 35-50 Stecker 7-pol.	Standard	7S2SK043020017A06
	8 m	DD	BSB 35-50 Stecker 7-pol.	Standard	7S2SK083020017A06
	4 m	DD	BSB 35-50 Stecker 7-pol.	High Flex Leder	7S2SH043020017A06
	8 m	DD	BSB 35-50 Stecker 7-pol.	High Flex Leder	7S2SH083020017A06

ABITIG® 17F	4 m	DD	BSB 35-50 Stecker 7-pol.	Standard	7S2FK043020017A06
	8 m	DD	BSB 35-50 Stecker 7-pol.	Standard	7S2FK083020017A06
	4 m	DD	BSB 35-50 Stecker 7-pol.	High Flex Leder	7S2FH043020017A06
	8 m	DD	BSB 35-50 Stecker 7-pol.	High Flex Leder	7S2FH083020017A06

Technische Änderungen vorbehalten • Verkaufspreise = unverbindliche Preisempfehlung - Angebot freibleibend • © Copyright

ABITIG®-Brennerpreisliste

passend für WIG-Stromquellen des Fabrikates „elektro-beckum“

Brennertyp	Länge	Schalterfunktion	maschinenseitiger Anschluss	Schlauchpaketausführung	Bestellnummer
ABITIG® 26	4 m	DD	BSB 35-50 Stecker 7-pol.	Standard	7S3SK043020017A06
	8 m	DD	BSB 35-50 Stecker 7-pol.	Standard	7S3SK083020017A06
	4 m	DD	BSB 35-50 Stecker 7-pol.	High Flex Leder	7S3SH043020017A06
	8 m	DD	BSB 35-50 Stecker 7-pol.	High Flex Leder	7S3SH083020017A06

ABITIG® 26F	4 m	DD	BSB 35-50 Stecker 7-pol.	Standard	7S3FK043020017A06
	8 m	DD	BSB 35-50 Stecker 7-pol.	Standard	7S3FK083020017A06
	4 m	DD	BSB 35-50 Stecker 7-pol.	High Flex Leder	7S3FH043020017A06
	8 m	DD	BSB 35-50 Stecker 7-pol.	High Flex Leder	7S3FH083020017A06

ABITIG® 24G	4 m	DD	BSB 35-50 Stecker 7-pol.	Standard	7S8SK043020017A06
	8 m	DD	BSB 35-50 Stecker 7-pol.	Standard	7S8SK083020017A06
	4 m	DD	BSB 35-50 Stecker 7-pol.	High Flex Leder	7S8SH043020017A06
	8 m	DD	BSB 35-50 Stecker 7-pol.	High Flex Leder	7S8SH083020017A06

ABITIG® 200	4 m	DD	BSB 35-50 Stecker 7-pol.	Standard	7T4SK043020017A06
	8 m	DD	BSB 35-50 Stecker 7-pol.	Standard	7T4SK083020017A06
	4 m	DD	BSB 35-50 Stecker 7-pol.	High Flex Leder	7T4SH043020017A06
	8 m	DD	BSB 35-50 Stecker 7-pol.	High Flex Leder	7T4SH083020017A06

ABITIG® 200F	4 m	DD	BSB 35-50 Stecker 7-pol.	Standard	7T4FK043020017A06
	8 m	DD	BSB 35-50 Stecker 7-pol.	Standard	7T4FK083020017A06
	4 m	DD	BSB 35-50 Stecker 7-pol.	High Flex Leder	7T4FH043020017A06
	8 m	DD	BSB 35-50 Stecker 7-pol.	High Flex Leder	7T4FH083020017A06

ABITIG® 150	4 m	DD	BSB 35-50 Stecker 7-pol.	Standard	7T6SK043020017A06
	8 m	DD	BSB 35-50 Stecker 7-pol.	Standard	7T6SK083020017A06
	4 m	DD	BSB 35-50 Stecker 7-pol.	High Flex Leder	7T6SH043020017A06
	8 m	DD	BSB 35-50 Stecker 7-pol.	High Flex Leder	7T6SH083020017A06

ABITIG® 150F	4 m	DD	BSB 35-50 Stecker 7-pol.	Standard	7T6FK043020017A06
	8 m	DD	BSB 35-50 Stecker 7-pol.	Standard	7T6FK083020017A06
	4 m	DD	BSB 35-50 Stecker 7-pol.	High Flex Leder	7T6FH043020017A06
	8 m	DD	BSB 35-50 Stecker 7-pol.	High Flex Leder	7T6FH083020017A06

ABITIG®-Brennerpreisliste

passend für WIG-Stromquellen des Fabrikates „elekra-beckum“



Brennertyp	Länge	Schalterfunktion	maschinenseitiger Anschluss	Schlauchpaketausführung	Bestellnummer
ABITIG® 9	4 m	DDP	BSB 10-25 Stecker 7-pol.	Standard	7S1SK046042219A06
	8 m	DDP	BSB 10-25 Stecker 7-pol.	Standard	7S1SK086042219A06
	4 m	DDP	BSB 10-25 Stecker 7-pol.	High Flex Leder	7S1SH046042219A06
	8 m	DDP	BSB 10-25 Stecker 7-pol.	High Flex Leder	7S1SH086042219A06
ABITIG® 9F	4 m	DDP	BSB 10-25 Stecker 7-pol.	Standard	7S1FK046042219A06
	8 m	DDP	BSB 10-25 Stecker 7-pol.	Standard	7S1FK086042219A06
	4 m	DDP	BSB 10-25 Stecker 7-pol.	High Flex Leder	7S1FH046042219A06
	8 m	DDP	BSB 10-25 Stecker 7-pol.	High Flex Leder	7S1FH086042219A06
ABITIG® 17	4 m	DDP	BSB 10-25 Stecker 7-pol.	Standard	7S2SK046042219A06
	8 m	DDP	BSB 10-25 Stecker 7-pol.	Standard	7S2SK086042219A06
	4 m	DDP	BSB 10-25 Stecker 7-pol.	High Flex Leder	7S2SH046042219A06
	8 m	DDP	BSB 10-25 Stecker 7-pol.	High Flex Leder	7S2SH086042219A06
ABITIG® 17F	4 m	DDP	BSB 10-25 Stecker 7-pol.	Standard	7S2FK046042219A06
	8 m	DDP	BSB 10-25 Stecker 7-pol.	Standard	7S2FK086042219A06
	4 m	DDP	BSB 10-25 Stecker 7-pol.	High Flex Leder	7S2FH046042219A06
	8 m	DDP	BSB 10-25 Stecker 7-pol.	High Flex Leder	7S2FH086042219A06

Technische Änderungen vorbehalten • Verkaufspreise = unverbindliche Preisempfehlung - Angebot freibleibend • © Copyright

ABITIG®-Brennerpreisliste

passend für WIG-Stromquellen des Fabrikates „elekra-beckum“

Brennertyp	Länge	Schalter-funktion	maschinenseitiger Anschluss	Schlauchpaket-ausführung	Bestellnummer
ABITIG® 26					
ABITIG® 26F					
ABITIG® 24G	4 m	DDP	BSB 10-25 Stecker 7-pol.	Standard	7S8SK046042219A06
	8 m	DDP	BSB 10-25 Stecker 7-pol.	Standard	7S8SK086042219A06
	4 m	DDP	BSB 10-25 Stecker 7-pol.	High Flex Leder	7S8SH046042219A06
	8 m	DDP	BSB 10-25 Stecker 7-pol.	High Flex Leder	7S8SH086042219A06
ABITIG® 200					
ABITIG® 200F					
ABITIG® 150	4 m	DDP	BSB 10-25 Stecker 7-pol.	Standard	7T6SK046042219A06
	8 m	DDP	BSB 10-25 Stecker 7-pol.	Standard	7T6SK086042219A06
	4 m	DDP	BSB 10-25 Stecker 7-pol.	High Flex Leder	7T6SH046042219A06
	8 m	DDP	BSB 10-25 Stecker 7-pol.	High Flex Leder	7T6SH086042219A06
ABITIG® 150F	4 m	DDP	BSB 10-25 Stecker 7-pol.	Standard	7T6FK046042219A06
	8 m	DDP	BSB 10-25 Stecker 7-pol.	Standard	7T6FK086042219A06
	4 m	DDP	BSB 10-25 Stecker 7-pol.	High Flex Leder	7T6FH046042219A06
	8 m	DDP	BSB 10-25 Stecker 7-pol.	High Flex Leder	7T6FH086042219A06

ABITIG®-Brennerpreisliste

passend für WIG-Stromquellen des Fabrikates „elekra-beckum“



Brennertyp	Länge	Schalterfunktion	maschinenseitiger Anschluss	Schlauchpaketausführung	Bestellnummer
ABITIG® 9	4 m	DDP	BSB 35-50 Stecker 7-pol.	Standard	7S1SK046040019A06
	8 m	DDP	BSB 35-50 Stecker 7-pol.	Standard	7S1SK086040019A06
	4 m	DDP	BSB 35-50 Stecker 7-pol.	High Flex Leder	7S1SH046040019A06
	8 m	DDP	BSB 35-50 Stecker 7-pol.	High Flex Leder	7S1SH086040019A06
ABITIG® 9F	4 m	DDP	BSB 35-50 Stecker 7-pol.	Standard	7S1FK046040019A06
	8 m	DDP	BSB 35-50 Stecker 7-pol.	Standard	7S1FK086040019A06
	4 m	DDP	BSB 35-50 Stecker 7-pol.	High Flex Leder	7S1FH046040019A06
	8 m	DDP	BSB 35-50 Stecker 7-pol.	High Flex Leder	7S1FH086040019A06
ABITIG® 17	4 m	DDP	BSB 35-50 Stecker 7-pol.	Standard	7S2SK046040019A06
	8 m	DDP	BSB 35-50 Stecker 7-pol.	Standard	7S2SK086040019A06
	4 m	DDP	BSB 35-50 Stecker 7-pol.	High Flex Leder	7S2SH046040019A06
	8 m	DDP	BSB 35-50 Stecker 7-pol.	High Flex Leder	7S2SH086040019A06
ABITIG® 17F	4 m	DDP	BSB 35-50 Stecker 7-pol.	Standard	7S2FK046040019A06
	8 m	DDP	BSB 35-50 Stecker 7-pol.	Standard	7S2FK086040019A06
	4 m	DDP	BSB 35-50 Stecker 7-pol.	High Flex Leder	7S2FH046040019A06
	8 m	DDP	BSB 35-50 Stecker 7-pol.	High Flex Leder	7S2FH086040019A06

Technische Änderungen vorbehalten • Verkaufspreise = unverbindliche Preisempfehlung - Angebot freibleibend • © Copyright

ABITIG®-Brennerpreisliste

passend für WIG-Stromquellen des Fabrikates „elektro-beckum“

Brennertyp	Länge	Schalterfunktion	maschinenseitiger Anschluss	Schlauchpaketausführung	Bestellnummer
ABITIG® 26	4 m	DDP	BSB 35-50 Stecker 7-pol.	Standard	7S3SK046040019A06
	8 m	DDP	BSB 35-50 Stecker 7-pol.	Standard	7S3SK086040019A06
	4 m	DDP	BSB 35-50 Stecker 7-pol.	High Flex Leder	7S3SH046040019A06
	8 m	DDP	BSB 35-50 Stecker 7-pol.	High Flex Leder	7S3SH086040019A06
ABITIG® 26F	4 m	DDP	BSB 35-50 Stecker 7-pol.	Standard	7S3FK046040019A06
	8 m	DDP	BSB 35-50 Stecker 7-pol.	Standard	7S3FK086040019A06
	4 m	DDP	BSB 35-50 Stecker 7-pol.	High Flex Leder	7S3FH046040019A06
	8 m	DDP	BSB 35-50 Stecker 7-pol.	High Flex Leder	7S3FH086040019A06
ABITIG® 24G	4 m	DDP	BSB 35-50 Stecker 7-pol.	Standard	7S8SK046040019A06
	8 m	DDP	BSB 35-50 Stecker 7-pol.	Standard	7S8SK086040019A06
	4 m	DDP	BSB 35-50 Stecker 7-pol.	High Flex Leder	7S8SH046040019A06
	8 m	DDP	BSB 35-50 Stecker 7-pol.	High Flex Leder	7S8SH086040019A06
ABITIG® 200	4 m	DDP	BSB 35-50 Stecker 7-pol.	Standard	7T4SK046040019A06
	8 m	DDP	BSB 35-50 Stecker 7-pol.	Standard	7T4SK086040019A06
	4 m	DDP	BSB 35-50 Stecker 7-pol.	High Flex Leder	7T4SH046040019A06
	8 m	DDP	BSB 35-50 Stecker 7-pol.	High Flex Leder	7T4SH086040019A06
ABITIG® 200F	4 m	DDP	BSB 35-50 Stecker 7-pol.	Standard	7T4FK046040019A06
	8 m	DDP	BSB 35-50 Stecker 7-pol.	Standard	7T4FK086040019A06
	4 m	DDP	BSB 35-50 Stecker 7-pol.	High Flex Leder	7T4FH046040019A06
	8 m	DDP	BSB 35-50 Stecker 7-pol.	High Flex Leder	7T4FH086040019A06
ABITIG® 150	4 m	DDP	BSB 35-50 Stecker 7-pol.	Standard	7T6SK046040019A06
	8 m	DDP	BSB 35-50 Stecker 7-pol.	Standard	7T6SK086040019A06
	4 m	DDP	BSB 35-50 Stecker 7-pol.	High Flex Leder	7T6SH046040019A06
	8 m	DDP	BSB 35-50 Stecker 7-pol.	High Flex Leder	7T6SH086040019A06
ABITIG® 150F	4 m	DDP	BSB 35-50 Stecker 7-pol.	Standard	7T6FK046040019A06
	8 m	DDP	BSB 35-50 Stecker 7-pol.	Standard	7T6FK086040019A06
	4 m	DDP	BSB 35-50 Stecker 7-pol.	High Flex Leder	7T6FH046040019A06
	8 m	DDP	BSB 35-50 Stecker 7-pol.	High Flex Leder	7T6FH086040019A06

ABITIG®-Brennerpreisliste

passend für WIG-Stromquellen des Fabrikates „elekra-beckum“

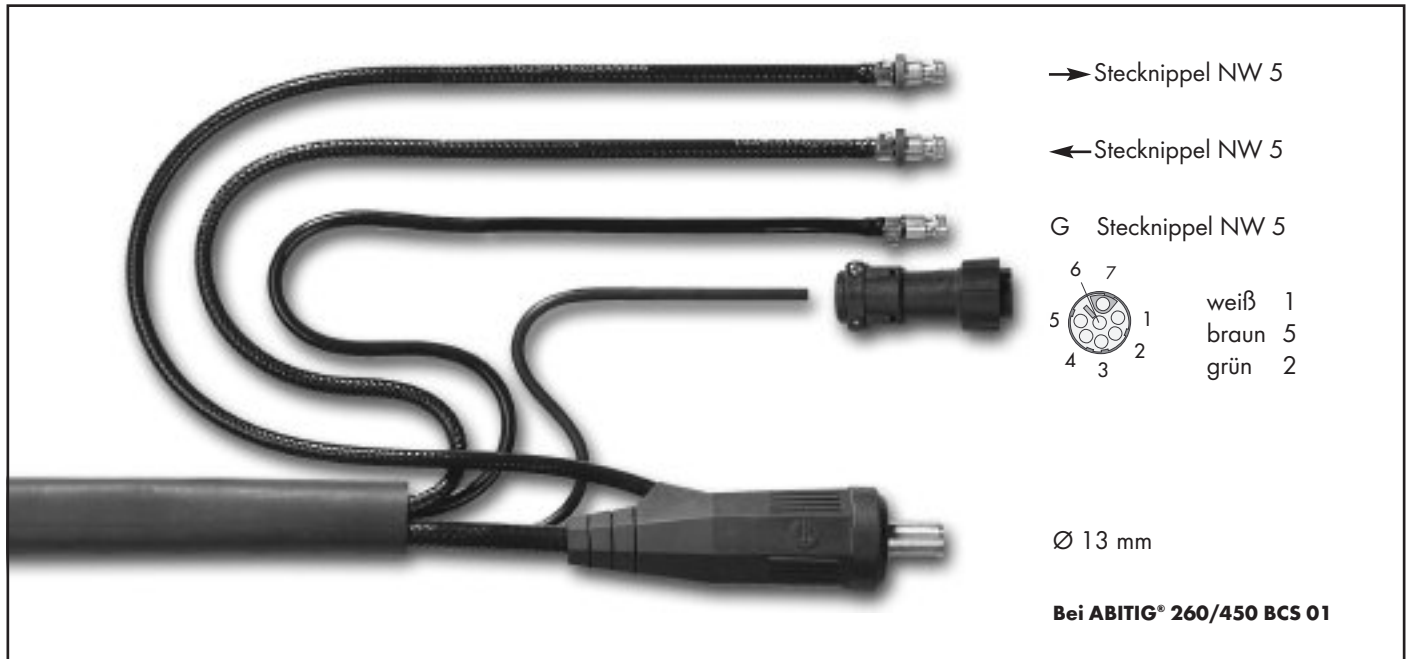

Brennertyp	Länge	Schalterfunktion	maschinenseitiger Anschluss	Schlauchpaketausführung	Bestellnummer
ABITIG® 18	4 m	DD	BSB 35-50 Stecker 7-pol.	Standard	7S4SK043020017A20
	8 m	DD	BSB 35-50 Stecker 7-pol.	Standard	7S4SK083020017A20
	4 m	DD	BSB 35-50 Stecker 7-pol.	High Flex Leder	7S4SH043020017A20
	8 m	DD	BSB 35-50 Stecker 7-pol.	High Flex Leder	7S4SH083020017A20
ABITIG® 18F	4 m	DD	BSB 35-50 Stecker 7-pol.	Standard	7S4FK043020017A20
	8 m	DD	BSB 35-50 Stecker 7-pol.	Standard	7S4FK083020017A20
	4 m	DD	BSB 35-50 Stecker 7-pol.	High Flex Leder	7S4FH043020017A20
	8 m	DD	BSB 35-50 Stecker 7-pol.	High Flex Leder	7S4FH083020017A20
ABITIG® 20	4 m	DD	BSB 35-50 Stecker 7-pol.	Standard	7S5SK043020017A20
	8 m	DD	BSB 35-50 Stecker 7-pol.	Standard	7S5SK083020017A20
	4 m	DD	BSB 35-50 Stecker 7-pol.	High Flex Leder	7S5SH043020017A20
	8 m	DD	BSB 35-50 Stecker 7-pol.	High Flex Leder	7S5SH083020017A20
ABITIG® 20F	4 m	DD	BSB 35-50 Stecker 7-pol.	Standard	7S5FK043020017A20
	8 m	DD	BSB 35-50 Stecker 7-pol.	Standard	7S5FK083020017A20
	4 m	DD	BSB 35-50 Stecker 7-pol.	High Flex Leder	7S5FH043020017A20
	8 m	DD	BSB 35-50 Stecker 7-pol.	High Flex Leder	7S5FH083020017A20

Technische Änderungen vorbehalten • Verkaufspreise = unverbindliche Preisempfehlung - Angebot freibleibend • © Copyright

ABITIG®-Brennerpreisliste

passend für WIG-Stromquellen des Fabrikates „elektro-beckum“

Brennertyp	Länge	Schalterfunktion	maschinenseitiger Anschluss	Schlauchpaketausführung	Bestellnummer
ABITIG® 12-1	4 m	DD	BSB 35-50 Stecker 7-pol.	Standard	7S6SK043020017A20
	8 m	DD	BSB 35-50 Stecker 7-pol.	Standard	7S6SK083020017A20
	4 m	DD	BSB 35-50 Stecker 7-pol.	High Flex Leder	7S6SH043020017A20
	8 m	DD	BSB 35-50 Stecker 7-pol.	High Flex Leder	7S6SH083020017A20
ABITIG® 18SC	4 m	DD	BSB 35-50 Stecker 7-pol.	Standard	7S7SK043020017A20
	8 m	DD	BSB 35-50 Stecker 7-pol.	Standard	7S7SK083020017A20
	4 m	DD	BSB 35-50 Stecker 7-pol.	High Flex Leder	7S7SH043020017A20
	8 m	DD	BSB 35-50 Stecker 7-pol.	High Flex Leder	7S7SH083020017A20
ABITIG® 24W	4 m	DD	BSB 35-50 Stecker 7-pol.	Standard	7S9SK043020017A20
	8 m	DD	BSB 35-50 Stecker 7-pol.	Standard	7S9SK083020017A20
	4 m	DD	BSB 35-50 Stecker 7-pol.	High Flex Leder	7S9SH043020017A20
	8 m	DD	BSB 35-50 Stecker 7-pol.	High Flex Leder	7S9SH083020017A20
ABITIG® 450W	4 m	DD	BSB 35-50 Stecker 7-pol.	Standard	7T5SK043020117A20
	8 m	DD	BSB 35-50 Stecker 7-pol.	Standard	7T5SK083020117A20
	4 m	DD	BSB 35-50 Stecker 7-pol.	High Flex Leder	7T5SH043020117A20
	8 m	DD	BSB 35-50 Stecker 7-pol.	High Flex Leder	7T5SH083020117A20
ABITIG® 260W	4 m	DD	BSB 35-50 Stecker 7-pol.	Standard	7T7SK043020117A20
	8 m	DD	BSB 35-50 Stecker 7-pol.	Standard	7T7SK083020117A20
	4 m	DD	BSB 35-50 Stecker 7-pol.	High Flex Leder	7T7SH043020117A20
	8 m	DD	BSB 35-50 Stecker 7-pol.	High Flex Leder	7T7SH083020117A20
ABITIG® 450W SC	4 m	DD	BSB 35-50 Stecker 7-pol.	Standard	
	8 m	DD	BSB 35-50 Stecker 7-pol.	Standard	
	4 m	DD	BSB 35-50 Stecker 7-pol.	High Flex Leder	7T8SH043020117A20
	8 m	DD	BSB 35-50 Stecker 7-pol.	High Flex Leder	7T8SH083020117A20

ABITIG®-Brennerpreisliste

passend für WIG-Stromquellen des Fabrikates „elekra-beckum“

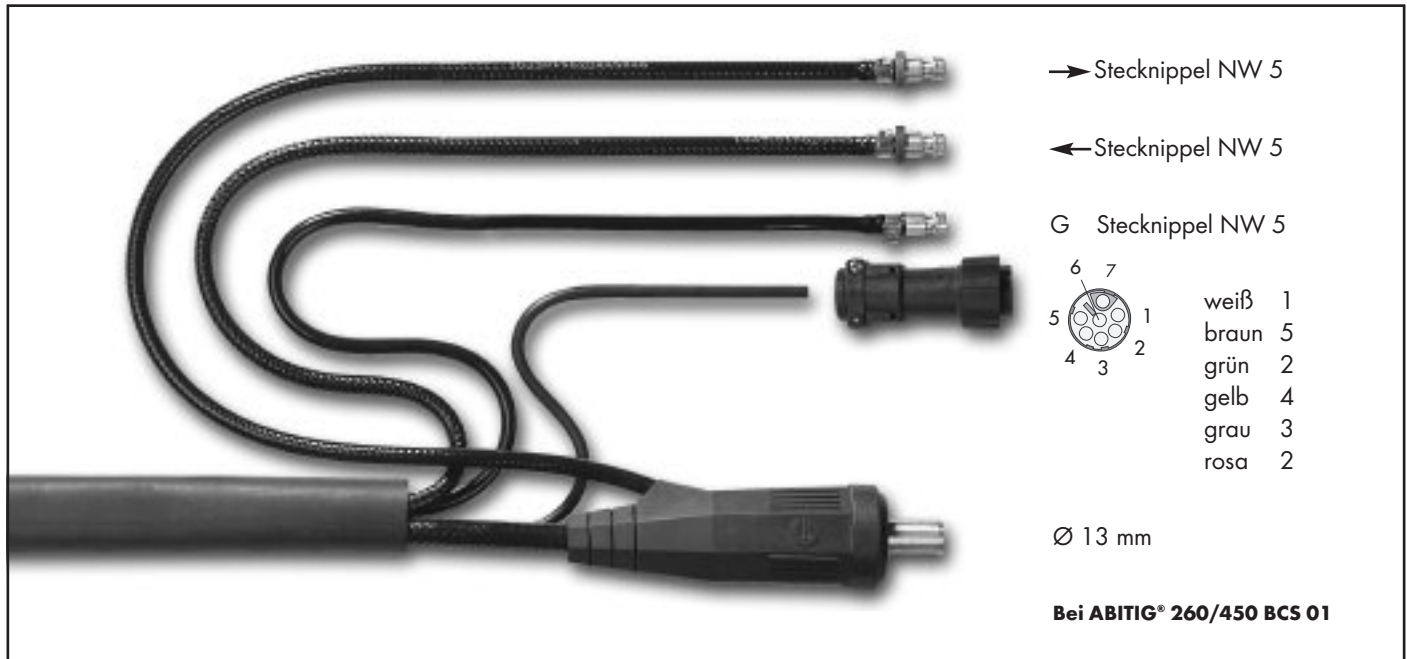

Brennertyp	Länge	Schalterfunktion	maschinenseitiger Anschluss	Schlauchpaketausführung	Bestellnummer
ABITIG® 18	4 m	DDP	BSB 35-50 Stecker 7-pol.	Standard	7S4SK046040019A20
	8 m	DDP	BSB 35-50 Stecker 7-pol.	Standard	7S4SK086040019A20
	4 m	DDP	BSB 35-50 Stecker 7-pol.	High Flex Leder	7S4SH046040019A20
	8 m	DDP	BSB 35-50 Stecker 7-pol.	High Flex Leder	7S4SH086040019A20
ABITIG® 18F	4 m	DDP	BSB 35-50 Stecker 7-pol.	Standard	7S4FK046040019A20
	8 m	DDP	BSB 35-50 Stecker 7-pol.	Standard	7S4FK086040019A20
	4 m	DDP	BSB 35-50 Stecker 7-pol.	High Flex Leder	7S4FH046040019A20
	8 m	DDP	BSB 35-50 Stecker 7-pol.	High Flex Leder	7S4FH086040019A20
ABITIG® 20	4 m	DDP	BSB 35-50 Stecker 7-pol.	Standard	7S5SK046040019A20
	8 m	DDP	BSB 35-50 Stecker 7-pol.	Standard	7S5SK086040019A20
	4 m	DDP	BSB 35-50 Stecker 7-pol.	High Flex Leder	7S5SH046040019A20
	8 m	DDP	BSB 35-50 Stecker 7-pol.	High Flex Leder	7S5SH086040019A20
ABITIG® 20F	4 m	DDP	BSB 35-50 Stecker 7-pol.	Standard	7S5FK046040019A20
	8 m	DDP	BSB 35-50 Stecker 7-pol.	Standard	7S5FK086040019A20
	4 m	DDP	BSB 35-50 Stecker 7-pol.	High Flex Leder	7S5FH046040019A20
	8 m	DDP	BSB 35-50 Stecker 7-pol.	High Flex Leder	7S5FH086040019A20

Technische Änderungen vorbehalten • Verkaufspreise = unverbindliche Preisempfehlung - Angebot freibleibend • © Copyright

ABITIG®-Brennerpreisliste

passend für WIG-Stromquellen des Fabrikates „elektro-beckum“

Brennertyp	Länge	Schalterfunktion	maschinenseitiger Anschluss	Schlauchpaketausführung	Bestellnummer
ABITIG® 12-1	4 m	DDP	BSB 35-50 Stecker 7-pol.	Standard	7S6SK046040019A20
	8 m	DDP	BSB 35-50 Stecker 7-pol.	Standard	7S6SK086040019A20
	4 m	DDP	BSB 35-50 Stecker 7-pol.	High Flex Leder	7S6SH046040019A20
	8 m	DDP	BSB 35-50 Stecker 7-pol.	High Flex Leder	7S6SH086040019A20
ABITIG® 18SC	4 m	DDP	BSB 35-50 Stecker 7-pol.	Standard	7S7SK046040019A20
	8 m	DDP	BSB 35-50 Stecker 7-pol.	Standard	7S7SK086040019A20
	4 m	DDP	BSB 35-50 Stecker 7-pol.	High Flex Leder	7S7SH046040019A20
	8 m	DDP	BSB 35-50 Stecker 7-pol.	High Flex Leder	7S7SH086040019A20
ABITIG® 24W	4 m	DDP	BSB 35-50 Stecker 7-pol.	Standard	7S9SK046040019A20
	8 m	DDP	BSB 35-50 Stecker 7-pol.	Standard	7S9SK086040019A20
	4 m	DDP	BSB 35-50 Stecker 7-pol.	High Flex Leder	7S9SH046040019A20
	8 m	DDP	BSB 35-50 Stecker 7-pol.	High Flex Leder	7S9SH086040019A20
ABITIG® 450W	4 m	DDP	BSB 35-50 Stecker 7-pol.	Standard	7T5SK046040119A20
	8 m	DDP	BSB 35-50 Stecker 7-pol.	Standard	7T5SK086040119A20
	4 m	DDP	BSB 35-50 Stecker 7-pol.	High Flex Leder	7T5SH046040119A20
	8 m	DDP	BSB 35-50 Stecker 7-pol.	High Flex Leder	7T5SH086040119A20
ABITIG® 260W	4 m	DDP	BSB 35-50 Stecker 7-pol.	Standard	7T7SK046040119A20
	8 m	DDP	BSB 35-50 Stecker 7-pol.	Standard	7T7SK086040119A20
	4 m	DDP	BSB 35-50 Stecker 7-pol.	High Flex Leder	7T7SH046040119A20
	8 m	DDP	BSB 35-50 Stecker 7-pol.	High Flex Leder	7T7SH086040119A20
ABITIG® 450W SC	4 m	DDP	BSB 35-50 Stecker 7-pol.	Standard	
	8 m	DDP	BSB 35-50 Stecker 7-pol.	Standard	
	4 m	DDP	BSB 35-50 Stecker 7-pol.	High Flex Leder	7T8SH046040119A20
	8 m	DDP	BSB 35-50 Stecker 7-pol.	High Flex Leder	7T8SH086040119A20

ABITIG®-Brennerpreisliste

passend für WIG-Stromquellen des Fabrikates „esab“



Brennertyp	Länge	Schalterfunktion	maschinenseitiger Anschluss	Schlauchpaketausführung	Bestellnummer
ABITIG® 9	4 m	ED	ZA 9-pol.	Standard	7S1SK047010799A00
	8 m	ED	ZA 9-pol.	Standard	7S1SK087010799A00
	4 m	ED	ZA 9-pol.	High Flex Leder	7S1SH047010799A00
	8 m	ED	ZA 9-pol.	High Flex Leder	7S1SH087010799A00
ABITIG® 9F	4 m	ED	ZA 9-pol.	Standard	7S1FK047010799A00
	8 m	ED	ZA 9-pol.	Standard	7S1FK087010799A00
	4 m	ED	ZA 9-pol.	High Flex Leder	7S1FH047010799A00
	8 m	ED	ZA 9-pol.	High Flex Leder	7S1FH087010799A00
ABITIG® 17	4 m	ED	ZA 9-pol.	Standard	7S2SK047010799A00
	8 m	ED	ZA 9-pol.	Standard	7S2SK087010799A00
	4 m	ED	ZA 9-pol.	High Flex Leder	7S2SH047010799A00
	8 m	ED	ZA 9-pol.	High Flex Leder	7S2SH087010799A00
ABITIG® 17F	4 m	ED	ZA 9-pol.	Standard	7S2FK047010799A00
	8 m	ED	ZA 9-pol.	Standard	7S2FK087010799A00
	4 m	ED	ZA 9-pol.	High Flex Leder	7S2FH047010799A00
	8 m	ED	ZA 9-pol.	High Flex Leder	7S2FH087010799A00

Technische Änderungen vorbehalten • Verkaufspreise = unverbindliche Preisempfehlung - Angebot freibleibend • © Copyright

ABITIG®-Brennerpreisliste

passend für WIG-Stromquellen des Fabrikates „esab“

Brennertyp	Länge	Schalterfunktion	maschinenseitiger Anschluss	Schlauchpaketausführung	Bestellnummer
ABITIG® 26	4 m	ED	ZA 9-pol.	Standard	7S3SK047010799A00
	8 m	ED	ZA 9-pol.	Standard	7S3SK087010799A00
	4 m	ED	ZA 9-pol.	High Flex Leder	7S3SH047010799A00
	8 m	ED	ZA 9-pol.	High Flex Leder	7S3SH087010799A00

ABITIG® 26F	4 m	ED	ZA 9-pol.	Standard	7S3FK047010799A00
	8 m	ED	ZA 9-pol.	Standard	7S3FK087010799A00
	4 m	ED	ZA 9-pol.	High Flex Leder	7S3FH047010799A00
	8 m	ED	ZA 9-pol.	High Flex Leder	7S3FH087010799A00

ABITIG® 24G	4 m	ED	ZA 9-pol.	Standard	7S8SK047010799A00
	8 m	ED	ZA 9-pol.	Standard	7S8SK087010799A00
	4 m	ED	ZA 9-pol.	High Flex Leder	7S8SH047010799A00
	8 m	ED	ZA 9-pol.	High Flex Leder	7S8SH087010799A00

ABITIG® 200	4 m	ED	ZA 9-pol.	Standard	7T4SK047010799A00
	8 m	ED	ZA 9-pol.	Standard	7T4SK087010799A00
	4 m	ED	ZA 9-pol.	High Flex Leder	7T4SH047010799A00
	8 m	ED	ZA 9-pol.	High Flex Leder	7T4SH087010799A00

ABITIG® 200F	4 m	ED	ZA 9-pol.	Standard	7T4FK047010799A00
	8 m	ED	ZA 9-pol.	Standard	7T4FK087010799A00
	4 m	ED	ZA 9-pol.	High Flex Leder	7T4FH047010799A00
	8 m	ED	ZA 9-pol.	High Flex Leder	7T4FH087010799A00

ABITIG® 150	4 m	ED	ZA 9-pol.	Standard	7T6SK047010799A00
	8 m	ED	ZA 9-pol.	Standard	7T6SK087010799A00
	4 m	ED	ZA 9-pol.	High Flex Leder	7T6SH047010799A00
	8 m	ED	ZA 9-pol.	High Flex Leder	7T6SH087010799A00

ABITIG® 150F	4 m	ED	ZA 9-pol.	Standard	7T6FK047010799A00
	8 m	ED	ZA 9-pol.	Standard	7T6FK087010799A00
	4 m	ED	ZA 9-pol.	High Flex Leder	7T6FH047010799A00
	8 m	ED	ZA 9-pol.	High Flex Leder	7T6FH087010799A00

ABITIG®-Brennerpreisliste

passend für WIG-Stromquellen des Fabrikates „esab“



Brennertyp	Länge	Schalterfunktion	maschinenseitiger Anschluss	Schlauchpaketausführung	Bestellnummer
ABITIG® 9	4 m	ED	BSB 35-50 Amphenol 2-pol.	Standard	7S1SK047010009A03
	8 m	ED	BSB 35-50 Amphenol 2-pol.	Standard	7S1SK087010009A03
	4 m	ED	BSB 35-50 Amphenol 2-pol.	High Flex Leder	7S1SH047010009A03
	8 m	ED	BSB 35-50 Amphenol 2-pol.	High Flex Leder	7S1SH087010009A03

ABITIG® 9F	4 m	ED	BSB 35-50 Amphenol 2-pol.	Standard	7S1FK047010009A03
	8 m	ED	BSB 35-50 Amphenol 2-pol.	Standard	7S1FK087010009A03
	4 m	ED	BSB 35-50 Amphenol 2-pol.	High Flex Leder	7S1FH047010009A03
	8 m	ED	BSB 35-50 Amphenol 2-pol.	High Flex Leder	7S1FH087010009A03

ABITIG® 17	4 m	ED	BSB 35-50 Amphenol 2-pol.	Standard	7S2SK047010009A03
	8 m	ED	BSB 35-50 Amphenol 2-pol.	Standard	7S2SK087010009A03
	4 m	ED	BSB 35-50 Amphenol 2-pol.	High Flex Leder	7S2SH047010009A03
	8 m	ED	BSB 35-50 Amphenol 2-pol.	High Flex Leder	7S2SH087010009A03

ABITIG® 17F	4 m	ED	BSB 35-50 Amphenol 2-pol.	Standard	7S2FK047010009A03
	8 m	ED	BSB 35-50 Amphenol 2-pol.	Standard	7S2FK087010009A03
	4 m	ED	BSB 35-50 Amphenol 2-pol.	High Flex Leder	7S2FH047010009A03
	8 m	ED	BSB 35-50 Amphenol 2-pol.	High Flex Leder	7S2FH087010009A03

Technische Änderungen vorbehalten • Verkaufspreise = unverbindliche Preisempfehlung - Angebot freibleibend • © Copyright

ABITIG®-Brennerpreisliste

passend für WIG-Stromquellen des Fabrikates „esab“

Brennertyp	Länge	Schalterfunktion	maschinenseitiger Anschluss	Schlauchpaketausführung	Bestellnummer
ABITIG® 26	4 m	ED	BSB 35-50 Amphenol 2-pol.	Standard	7S3SK047010009A03
	8 m	ED	BSB 35-50 Amphenol 2-pol.	Standard	7S3SK087010009A03
	4 m	ED	BSB 35-50 Amphenol 2-pol.	High Flex Leder	7S3SH047010009A03
	8 m	ED	BSB 35-50 Amphenol 2-pol.	High Flex Leder	7S3SH087010009A03
ABITIG® 26F	4 m	ED	BSB 35-50 Amphenol 2-pol.	Standard	7S3FK047010009A03
	8 m	ED	BSB 35-50 Amphenol 2-pol.	Standard	7S3FK087010009A03
	4 m	ED	BSB 35-50 Amphenol 2-pol.	High Flex Leder	7S3FH047010009A03
	8 m	ED	BSB 35-50 Amphenol 2-pol.	High Flex Leder	7S3FH087010009A03
ABITIG® 24G	4 m	ED	BSB 35-50 Amphenol 2-pol.	Standard	7S8SK047010009A03
	8 m	ED	BSB 35-50 Amphenol 2-pol.	Standard	7S8SK087010009A03
	4 m	ED	BSB 35-50 Amphenol 2-pol.	High Flex Leder	7S8SH047010009A03
	8 m	ED	BSB 35-50 Amphenol 2-pol.	High Flex Leder	7S8SH087010009A03
ABITIG® 200	4 m	ED	BSB 35-50 Amphenol 2-pol.	Standard	7T4SK047010009A03
	8 m	ED	BSB 35-50 Amphenol 2-pol.	Standard	7T4SK087010009A03
	4 m	ED	BSB 35-50 Amphenol 2-pol.	High Flex Leder	7T4SH047010009A03
	8 m	ED	BSB 35-50 Amphenol 2-pol.	High Flex Leder	7T4SH087010009A03
ABITIG® 200F	4 m	ED	BSB 35-50 Amphenol 2-pol.	Standard	7T4FK047010009A03
	8 m	ED	BSB 35-50 Amphenol 2-pol.	Standard	7T4FK087010009A03
	4 m	ED	BSB 35-50 Amphenol 2-pol.	High Flex Leder	7T4FH047010009A03
	8 m	ED	BSB 35-50 Amphenol 2-pol.	High Flex Leder	7T4FH087010009A03
ABITIG® 150	4 m	ED	BSB 35-50 Amphenol 2-pol.	Standard	7T6SK047010009A03
	8 m	ED	BSB 35-50 Amphenol 2-pol.	Standard	7T6SK087010009A03
	4 m	ED	BSB 35-50 Amphenol 2-pol.	High Flex Leder	7T6SH047010009A03
	8 m	ED	BSB 35-50 Amphenol 2-pol.	High Flex Leder	7T6SH087010009A03
ABITIG® 150F	4 m	ED	BSB 35-50 Amphenol 2-pol.	Standard	7T6FK047010009A03
	8 m	ED	BSB 35-50 Amphenol 2-pol.	Standard	7T6FK087010009A03
	4 m	ED	BSB 35-50 Amphenol 2-pol.	High Flex Leder	7T6FH047010009A03
	8 m	ED	BSB 35-50 Amphenol 2-pol.	High Flex Leder	7T6FH087010009A03

ABITIG®-Brennerpreisliste

passend für WIG-Stromquellen des Fabrikates „esab“



Brennertyp	Länge	Schalterfunktion	maschinenseitiger Anschluss	Schlauchpaketausführung	Bestellnummer
ABITIG® 9	4 m	EDP	ZA 9-pol./Burndy 12-pol.	Standard	7S1SK047040739A00
	8 m	EDP	ZA 9-pol./Burndy 12-pol.	Standard	7S1SK087040739A00
	4 m	EDP	ZA 9-pol./Burndy 12-pol.	High Flex Leder	7S1SH047040739A00
	8 m	EDP	ZA 9-pol./Burndy 12-pol.	High Flex Leder	7S1SH087040739A00

ABITIG® 9F	4 m	EDP	ZA 9-pol./Burndy 12-pol.	Standard	7S1FK047040739A00
	8 m	EDP	ZA 9-pol./Burndy 12-pol.	Standard	7S1FK087040739A00
	4 m	EDP	ZA 9-pol./Burndy 12-pol.	High Flex Leder	7S1FH047040739A00
	8 m	EDP	ZA 9-pol./Burndy 12-pol.	High Flex Leder	7S1FH087040739A00

ABITIG® 17	4 m	EDP	ZA 9-pol./Burndy 12-pol.	Standard	7S2SK047040739A00
	8 m	EDP	ZA 9-pol./Burndy 12-pol.	Standard	7S2SK087040739A00
	4 m	EDP	ZA 9-pol./Burndy 12-pol.	High Flex Leder	7S2SH047040739A00
	8 m	EDP	ZA 9-pol./Burndy 12-pol.	High Flex Leder	7S2SH087040739A00

ABITIG® 17F	4 m	EDP	ZA 9-pol./Burndy 12-pol.	Standard	7S2FK047040739A00
	8 m	EDP	ZA 9-pol./Burndy 12-pol.	Standard	7S2FK087040739A00
	4 m	EDP	ZA 9-pol./Burndy 12-pol.	High Flex Leder	7S2FH047040739A00
	8 m	EDP	ZA 9-pol./Burndy 12-pol.	High Flex Leder	7S2FH087040739A00

Technische Änderungen vorbehalten • Verkaufspreise = unverbindliche Preisempfehlung - Angebot freibleibend • © Copyright

ABITIG®-Brennerpreisliste

passend für WIG-Stromquellen des Fabrikates „esab“

Brennertyp	Länge	Schalterfunktion	maschinenseitiger Anschluss	Schlauchpaketausführung	Bestellnummer
ABITIG® 26	4 m	EDP	ZA 9-pol./Burndy 12-pol.	Standard	7S3SK047040739A00
	8 m	EDP	ZA 9-pol./Burndy 12-pol.	Standard	7S3SK087040739A00
	4 m	EDP	ZA 9-pol./Burndy 12-pol.	High Flex Leder	7S3SH047040739A00
	8 m	EDP	ZA 9-pol./Burndy 12-pol.	High Flex Leder	7S3SH087040739A00

ABITIG® 26F	4 m	EDP	ZA 9-pol./Burndy 12-pol.	Standard	7S3FK047040739A00
	8 m	EDP	ZA 9-pol./Burndy 12-pol.	Standard	7S3FK087040739A00
	4 m	EDP	ZA 9-pol./Burndy 12-pol.	High Flex Leder	7S3FH047040739A00
	8 m	EDP	ZA 9-pol./Burndy 12-pol.	High Flex Leder	7S3FH087040739A00

ABITIG® 24G	4 m	EDP	ZA 9-pol./Burndy 12-pol.	Standard	7S8SK047040739A00
	8 m	EDP	ZA 9-pol./Burndy 12-pol.	Standard	7S8SK087040739A00
	4 m	EDP	ZA 9-pol./Burndy 12-pol.	High Flex Leder	7S8SH047040739A00
	8 m	EDP	ZA 9-pol./Burndy 12-pol.	High Flex Leder	7S8SH087040739A00

ABITIG® 200	4 m	EDP	ZA 9-pol./Burndy 12-pol.	Standard	7T4SK047040739A00
	8 m	EDP	ZA 9-pol./Burndy 12-pol.	Standard	7T4SK087040739A00
	4 m	EDP	ZA 9-pol./Burndy 12-pol.	High Flex Leder	7T4SH047040739A00
	8 m	EDP	ZA 9-pol./Burndy 12-pol.	High Flex Leder	7T4SH087040739A00

ABITIG® 200F	4 m	EDP	ZA 9-pol./Burndy 12-pol.	Standard	7T4FK047040739A00
	8 m	EDP	ZA 9-pol./Burndy 12-pol.	Standard	7T4FK087040739A00
	4 m	EDP	ZA 9-pol./Burndy 12-pol.	High Flex Leder	7T4FH047040739A00
	8 m	EDP	ZA 9-pol./Burndy 12-pol.	High Flex Leder	7T4FH087040739A00

ABITIG® 150	4 m	EDP	ZA 9-pol./Burndy 12-pol.	Standard	7T6SK047040739A00
	8 m	EDP	ZA 9-pol./Burndy 12-pol.	Standard	7T6SK087040739A00
	4 m	EDP	ZA 9-pol./Burndy 12-pol.	High Flex Leder	7T6SH047040739A00
	8 m	EDP	ZA 9-pol./Burndy 12-pol.	High Flex Leder	7T6SH087040739A00

ABITIG® 150F	4 m	EDP	ZA 9-pol./Burndy 12-pol.	Standard	7T6FK047040739A00
	8 m	EDP	ZA 9-pol./Burndy 12-pol.	Standard	7T6FK087040739A00
	4 m	EDP	ZA 9-pol./Burndy 12-pol.	High Flex Leder	7T6FH047040739A00
	8 m	EDP	ZA 9-pol./Burndy 12-pol.	High Flex Leder	7T6FH087040739A00

ABITIG®-Brennerpreisliste

passend für WIG-Stromquellen des Fabrikates „esab“



Brennertyp	Länge	Schalterfunktion	maschinenseitiger Anschluss	Schlauchpaketausführung	Bestellnummer
ABITIG® 9	4 m	ED	BSB 10-25 Amphenol 2-pol.	Standard	7S1SK047012709A03
	8 m	ED	BSB 10-25 Amphenol 2-pol.	Standard	7S1SK087012709A03
	4 m	ED	BSB 10-25 Amphenol 2-pol.	High Flex Leder	7S1SH047012709A03
	8 m	ED	BSB 10-25 Amphenol 2-pol.	High Flex Leder	7S1SH087012709A03
ABITIG® 9F	4 m	ED	BSB 10-25 Amphenol 2-pol.	Standard	7S1FK047012709A03
	8 m	ED	BSB 10-25 Amphenol 2-pol.	Standard	7S1FK087012709A03
	4 m	ED	BSB 10-25 Amphenol 2-pol.	High Flex Leder	7S1FH047012709A03
	8 m	ED	BSB 10-25 Amphenol 2-pol.	High Flex Leder	7S1FH087012709A03
ABITIG® 17	4 m	ED	BSB 10-25 Amphenol 2-pol.	Standard	7S2SK047012709A03
	8 m	ED	BSB 10-25 Amphenol 2-pol.	Standard	7S2SK087012709A03
	4 m	ED	BSB 10-25 Amphenol 2-pol.	High Flex Leder	7S2SH047012709A03
	8 m	ED	BSB 10-25 Amphenol 2-pol.	High Flex Leder	7S2SH087012709A03
ABITIG® 17F	4 m	ED	BSB 10-25 Amphenol 2-pol.	Standard	7S2FK047012709A03
	8 m	ED	BSB 10-25 Amphenol 2-pol.	Standard	7S2FK087012709A03
	4 m	ED	BSB 10-25 Amphenol 2-pol.	High Flex Leder	7S2FH047012709A03
	8 m	ED	BSB 10-25 Amphenol 2-pol.	High Flex Leder	7S2FH087012709A03

Technische Änderungen vorbehalten • Verkaufspreise = unverbindliche Preisempfehlung - Angebot freibleibend • © Copyright

ABITIG®-Brennerpreisliste

passend für WIG-Stromquellen des Fabrikates „esab“

Brennertyp	Länge	Schalterfunktion	maschinenseitiger Anschluss	Schlauchpaketausführung	Bestellnummer
ABITIG® 26	4 m	ED	BSB 10-25 Amphenol 2-pol.	Standard	7S3SK047012709A03
	8 m	ED	BSB 10-25 Amphenol 2-pol.	Standard	7S3SK087012709A03
	4 m	ED	BSB 10-25 Amphenol 2-pol.	High Flex Leder	7S3SH047012709A03
	8 m	ED	BSB 10-25 Amphenol 2-pol.	High Flex Leder	7S3SH087012709A03
ABITIG® 26F	4 m	ED	BSB 10-25 Amphenol 2-pol.	Standard	7S3FK047012709A03
	8 m	ED	BSB 10-25 Amphenol 2-pol.	Standard	7S3FK087012709A03
	4 m	ED	BSB 10-25 Amphenol 2-pol.	High Flex Leder	7S3FH047012709A03
	8 m	ED	BSB 10-25 Amphenol 2-pol.	High Flex Leder	7S3FH087012709A03
ABITIG® 24G	4 m	ED	BSB 10-25 Amphenol 2-pol.	Standard	7S8SK047012709A03
	8 m	ED	BSB 10-25 Amphenol 2-pol.	Standard	7S8SK087012709A03
	4 m	ED	BSB 10-25 Amphenol 2-pol.	High Flex Leder	7S8SH047012709A03
	8 m	ED	BSB 10-25 Amphenol 2-pol.	High Flex Leder	7S8SH087012709A03
ABITIG® 200	4 m	ED	BSB 10-25 Amphenol 2-pol.	Standard	7T4SK047012709A03
	8 m	ED	BSB 10-25 Amphenol 2-pol.	Standard	7T4SK087012709A03
	4 m	ED	BSB 10-25 Amphenol 2-pol.	High Flex Leder	7T4SH047012709A03
	8 m	ED	BSB 10-25 Amphenol 2-pol.	High Flex Leder	7T4SH087012709A03
ABITIG® 200F	4 m	ED	BSB 10-25 Amphenol 2-pol.	Standard	7T4FK047012709A03
	8 m	ED	BSB 10-25 Amphenol 2-pol.	Standard	7T4FK087012709A03
	4 m	ED	BSB 10-25 Amphenol 2-pol.	High Flex Leder	7T4FH047012709A03
	8 m	ED	BSB 10-25 Amphenol 2-pol.	High Flex Leder	7T4FH087012709A03
ABITIG® 150	4 m	ED	BSB 10-25 Amphenol 2-pol.	Standard	7T6SK047012709A03
	8 m	ED	BSB 10-25 Amphenol 2-pol.	Standard	7T6SK087012709A03
	4 m	ED	BSB 10-25 Amphenol 2-pol.	High Flex Leder	7T6SH047012709A03
	8 m	ED	BSB 10-25 Amphenol 2-pol.	High Flex Leder	7T6SH087012709A03
ABITIG® 150F	4 m	ED	BSB 10-25 Amphenol 2-pol.	Standard	7T6FK047012709A03
	8 m	ED	BSB 10-25 Amphenol 2-pol.	Standard	7T6FK087012709A03
	4 m	ED	BSB 10-25 Amphenol 2-pol.	High Flex Leder	7T6FH047012709A03
	8 m	ED	BSB 10-25 Amphenol 2-pol.	High Flex Leder	7T6FH087012709A03

ABITIG®-Brennerpreisliste

passend für WIG-Stromquellen des Fabrikates „esab“



Brennertyp	Länge	Schalterfunktion	maschinenseitiger Anschluss	Schlauchpaketausführung	Bestellnummer
ABITIG® 9	4 m	ED	BSB 10-25 Redelstecker 2-pol.	Standard	7S1SK047012754A05
	8 m	ED	BSB 10-25 Redelstecker 2-pol.	Standard	7S1SK087012754A05
	4 m	ED	BSB 10-25 Redelstecker 2-pol.	High Flex Leder	7S1SH047012754A05
	8 m	ED	BSB 10-25 Redelstecker 2-pol.	High Flex Leder	7S1SH087012754A05
ABITIG® 9F	4 m	ED	BSB 10-25 Redelstecker 2-pol.	Standard	7S1FK047012754A05
	8 m	ED	BSB 10-25 Redelstecker 2-pol.	Standard	7S1FK087012754A05
	4 m	ED	BSB 10-25 Redelstecker 2-pol.	High Flex Leder	7S1FH047012754A05
	8 m	ED	BSB 10-25 Redelstecker 2-pol.	High Flex Leder	7S1FH087012754A05
ABITIG® 17	4 m	ED	BSB 10-25 Redelstecker 2-pol.	Standard	7S2SK047012754A05
	8 m	ED	BSB 10-25 Redelstecker 2-pol.	Standard	7S2SK087012754A05
	4 m	ED	BSB 10-25 Redelstecker 2-pol.	High Flex Leder	7S2SH047012754A05
	8 m	ED	BSB 10-25 Redelstecker 2-pol.	High Flex Leder	7S2SH087012754A05
ABITIG® 17F	4 m	ED	BSB 10-25 Redelstecker 2-pol.	Standard	7S2FK047012754A05
	8 m	ED	BSB 10-25 Redelstecker 2-pol.	Standard	7S2FK087012754A05
	4 m	ED	BSB 10-25 Redelstecker 2-pol.	High Flex Leder	7S2FH047012754A05
	8 m	ED	BSB 10-25 Redelstecker 2-pol.	High Flex Leder	7S2FH087012754A05

Technische Änderungen vorbehalten • Verkaufspreise = unverbindliche Preisempfehlung - Angebot freibleibend • © Copyright

ABITIG®-Brennerpreisliste

passend für WIG-Stromquellen des Fabrikates „esab“

Brennertyp	Länge	Schalterfunktion	maschinenseitiger Anschluss	Schlauchpaketausführung	Bestellnummer	
ABITIG® 26	4 m	ED	BSB 10-25	Redelstecker 2-pol.	Standard	7S3SK047012754A05
	8 m	ED	BSB 10-25	Redelstecker 2-pol.	Standard	7S3SK087012754A05
	4 m	ED	BSB 10-25	Redelstecker 2-pol.	High Flex Leder	7S3SH047012754A05
	8 m	ED	BSB 10-25	Redelstecker 2-pol.	High Flex Leder	7S3SH087012754A05
ABITIG® 26F	4 m	ED	BSB 10-25	Redelstecker 2-pol.	Standard	7S3FK047012754A05
	8 m	ED	BSB 10-25	Redelstecker 2-pol.	Standard	7S3FK087012754A05
	4 m	ED	BSB 10-25	Redelstecker 2-pol.	High Flex Leder	7S3FH047012754A05
	8 m	ED	BSB 10-25	Redelstecker 2-pol.	High Flex Leder	7S3FH087012754A05
ABITIG® 24G	4 m	ED	BSB 10-25	Redelstecker 2-pol.	Standard	7S8SK047012754A05
	8 m	ED	BSB 10-25	Redelstecker 2-pol.	Standard	7S8SK087012754A05
	4 m	ED	BSB 10-25	Redelstecker 2-pol.	High Flex Leder	7S8SH047012754A05
	8 m	ED	BSB 10-25	Redelstecker 2-pol.	High Flex Leder	7S8SH087012754A05
ABITIG® 200	4 m	ED	BSB 10-25	Redelstecker 2-pol.	Standard	7T4SK047012754A05
	8 m	ED	BSB 10-25	Redelstecker 2-pol.	Standard	7T4SK087012754A05
	4 m	ED	BSB 10-25	Redelstecker 2-pol.	High Flex Leder	7T4SH047012754A05
	8 m	ED	BSB 10-25	Redelstecker 2-pol.	High Flex Leder	7T4SH087012754A05
ABITIG® 200F	4 m	ED	BSB 10-25	Redelstecker 2-pol.	Standard	7T4FK047012754A05
	8 m	ED	BSB 10-25	Redelstecker 2-pol.	Standard	7T4FK087012754A05
	4 m	ED	BSB 10-25	Redelstecker 2-pol.	High Flex Leder	7T4FH047012754A05
	8 m	ED	BSB 10-25	Redelstecker 2-pol.	High Flex Leder	7T4FH087012754A05
ABITIG® 150	4 m	ED	BSB 10-25	Redelstecker 2-pol.	Standard	7T6SK047012754A05
	8 m	ED	BSB 10-25	Redelstecker 2-pol.	Standard	7T6SK087012754A05
	4 m	ED	BSB 10-25	Redelstecker 2-pol.	High Flex Leder	7T6SH047012754A05
	8 m	ED	BSB 10-25	Redelstecker 2-pol.	High Flex Leder	7T6SH087012754A05
ABITIG® 150F	4 m	ED	BSB 10-25	Redelstecker 2-pol.	Standard	7T6FK047012754A05
	8 m	ED	BSB 10-25	Redelstecker 2-pol.	Standard	7T6FK087012754A05
	4 m	ED	BSB 10-25	Redelstecker 2-pol.	High Flex Leder	7T6FH047012754A05
	8 m	ED	BSB 10-25	Redelstecker 2-pol.	High Flex Leder	7T6FH087012754A05

ABITIG®-Brennerpreisliste

passend für WIG-Stromquellen des Fabrikates „esab“



Brennertyp	Länge	Schalterfunktion	maschinenseitiger Anschluss	Schlauchpaketausführung	Bestellnummer
ABITIG® 18	4 m	ED	ZA 9-pol.	Standard	7S4SK047010799B12
	8 m	ED	ZA 9-pol.	Standard	7S4SK087010799B12
	4 m	ED	ZA 9-pol.	High Flex Leder	7S4SH047010799B12
	8 m	ED	ZA 9-pol.	High Flex Leder	7S4SH087010799B12
ABITIG® 18F	4 m	ED	ZA 9-pol.	Standard	7S4FK047010799B12
	8 m	ED	ZA 9-pol.	Standard	7S4FK087010799B12
	4 m	ED	ZA 9-pol.	High Flex Leder	7S4FH047010799B12
	8 m	ED	ZA 9-pol.	High Flex Leder	7S4FH087010799B12
ABITIG® 20	4 m	ED	ZA 9-pol.	Standard	7S5SK047010799B12
	8 m	ED	ZA 9-pol.	Standard	7S5SK087010799B12
	4 m	ED	ZA 9-pol.	High Flex Leder	7S5SH047010799B12
	8 m	ED	ZA 9-pol.	High Flex Leder	7S5SH087010799B12
ABITIG® 20F	4 m	ED	ZA 9-pol.	Standard	7S5FK047010799B12
	8 m	ED	ZA 9-pol.	Standard	7S5FK087010799B12
	4 m	ED	ZA 9-pol.	High Flex Leder	7S5FH047010799B12
	8 m	ED	ZA 9-pol.	High Flex Leder	7S5FH087010799B12

Technische Änderungen vorbehalten • Verkaufspreise = unverbindliche Preisempfehlung - Angebot freibleibend • © Copyright

ABITIG®-Brennerpreisliste

passend für WIG-Stromquellen des Fabrikates „esab“

Brennertyp	Länge	Schalterfunktion	maschinenseitiger Anschluss	Schlauchpaketausführung	Bestellnummer
ABITIG® 12-1	4 m	ED	ZA 9-pol.	Standard	7S6SK047010799B12
	8 m	ED	ZA 9-pol.	Standard	7S6SK087010799B12
	4 m	ED	ZA 9-pol.	High Flex Leder	7S6SH047010799B12
	8 m	ED	ZA 9-pol.	High Flex Leder	7S6SH087010799B12
ABITIG® 18SC	4 m	ED	ZA 9-pol.	Standard	7S7SK047010799B12
	8 m	ED	ZA 9-pol.	Standard	7S7SK087010799B12
	4 m	ED	ZA 9-pol.	High Flex Leder	7S7SH047010799B12
	8 m	ED	ZA 9-pol.	High Flex Leder	7S7SH087010799B12
ABITIG® 24W	4 m	ED	ZA 9-pol.	Standard	7S9SK047010799B12
	8 m	ED	ZA 9-pol.	Standard	7S9SK087010799B12
	4 m	ED	ZA 9-pol.	High Flex Leder	7S9SH047010799B12
	8 m	ED	ZA 9-pol.	High Flex Leder	7S9SH087010799B12
ABITIG® 450W	4 m	ED	ZA 9-pol.	Standard	7T5SK047010799B12
	8 m	ED	ZA 9-pol.	Standard	7T5SK087010799B12
	4 m	ED	ZA 9-pol.	High Flex Leder	7T5SH047010799B12
	8 m	ED	ZA 9-pol.	High Flex Leder	7T5SH087010799B12
ABITIG® 260W	4 m	ED	ZA 9-pol.	Standard	7T7SK047010799B12
	8 m	ED	ZA 9-pol.	Standard	7T7SK087010799B12
	4 m	ED	ZA 9-pol.	High Flex Leder	7T7SH047010799B12
	8 m	ED	ZA 9-pol.	High Flex Leder	7T7SH087010799B12
ABITIG® 450W SC	4 m	ED	ZA 9-pol.	Standard	
	8 m	ED	ZA 9-pol.	Standard	
	4 m	ED	ZA 9-pol.	High Flex Leder	7T8SH047010799B12
	8 m	ED	ZA 9-pol.	High Flex Leder	7T8SH087010799B12

ABITIG®-Brennerpreisliste

passend für WIG-Stromquellen des Fabrikates „esab“

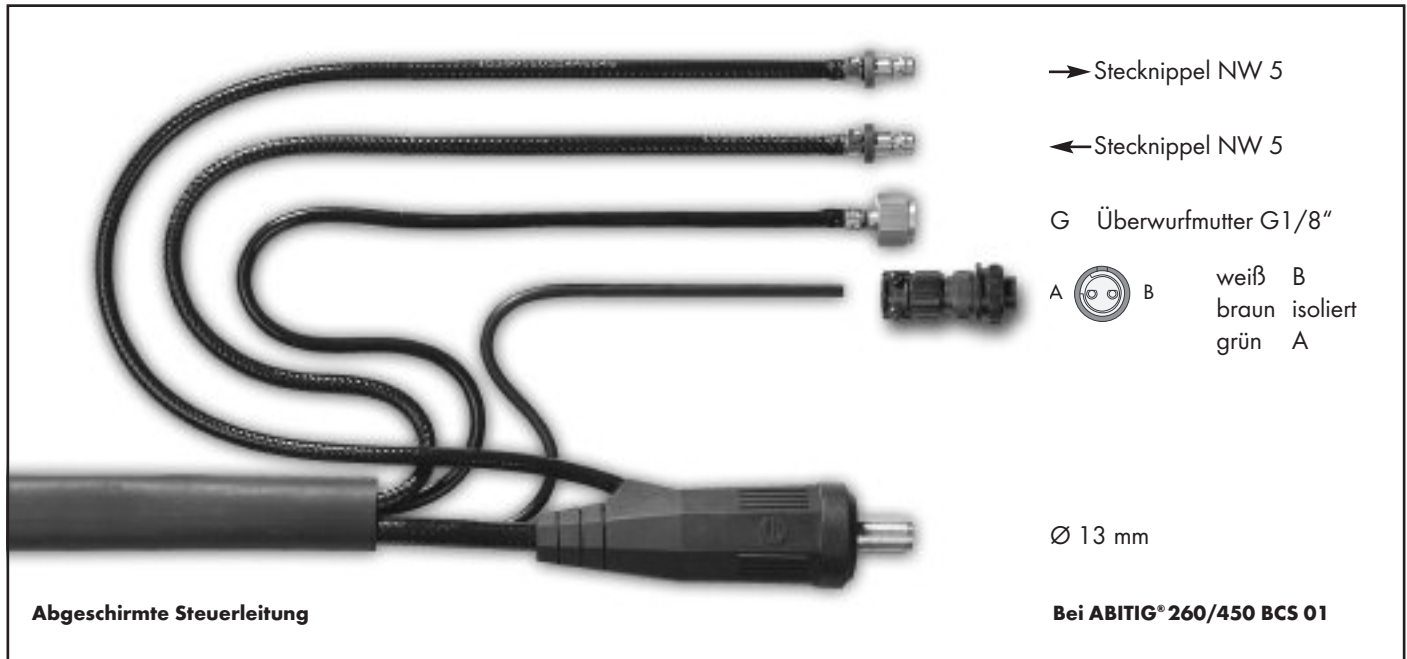

Brennertyp	Länge	Schalterfunktion	maschinenseitiger Anschluss	Schlauchpaketausführung	Bestellnummer
ABITIG® 18	4 m	ED	BSB 35-50 Amphenol 2-pol.	Standard	7S4SK047010009A21
	8 m	ED	BSB 35-50 Amphenol 2-pol.	Standard	7S4SK087010009A21
	4 m	ED	BSB 35-50 Amphenol 2-pol.	High Flex Leder	7S4SH047010009A21
	8 m	ED	BSB 35-50 Amphenol 2-pol.	High Flex Leder	7S4SH087010009A21
ABITIG® 18F	4 m	ED	BSB 35-50 Amphenol 2-pol.	Standard	7S4FK047010009A21
	8 m	ED	BSB 35-50 Amphenol 2-pol.	Standard	7S4FK087010009A21
	4 m	ED	BSB 35-50 Amphenol 2-pol.	High Flex Leder	7S4FH047010009A21
	8 m	ED	BSB 35-50 Amphenol 2-pol.	High Flex Leder	7S4FH087010009A21
ABITIG® 20	4 m	ED	BSB 35-50 Amphenol 2-pol.	Standard	7S5SK047010009A21
	8 m	ED	BSB 35-50 Amphenol 2-pol.	Standard	7S5SK087010009A21
	4 m	ED	BSB 35-50 Amphenol 2-pol.	High Flex Leder	7S5SH047010009A21
	8 m	ED	BSB 35-50 Amphenol 2-pol.	High Flex Leder	7S5SH087010009A21
ABITIG® 20F	4 m	ED	BSB 35-50 Amphenol 2-pol.	Standard	7S5FK047010009A21
	8 m	ED	BSB 35-50 Amphenol 2-pol.	Standard	7S5FK087010009A21
	4 m	ED	BSB 35-50 Amphenol 2-pol.	High Flex Leder	7S5FH047010009A21
	8 m	ED	BSB 35-50 Amphenol 2-pol.	High Flex Leder	7S5FH087010009A21

Technische Änderungen vorbehalten • Verkaufspreise = unverbindliche Preisempfehlung - Angebot freibleibend • © Copyright

ABITIG®-Brennerpreisliste

passend für WIG-Stromquellen des Fabrikates „esab“

Brennertyp	Länge	Schalterfunktion	maschinenseitiger Anschluss	Schlauchpaketausführung	Bestellnummer
ABITIG® 12-1	4 m	ED	BSB 35-50 Amphenol 2-pol.	Standard	7S6SK047010009A21
	8 m	ED	BSB 35-50 Amphenol 2-pol.	Standard	7S6SK087010009A21
	4 m	ED	BSB 35-50 Amphenol 2-pol.	High Flex Leder	7S6SH047010009A21
	8 m	ED	BSB 35-50 Amphenol 2-pol.	High Flex Leder	7S6SH087010009A21
ABITIG® 18SC	4 m	ED	BSB 35-50 Amphenol 2-pol.	Standard	7S7SK047010009A21
	8 m	ED	BSB 35-50 Amphenol 2-pol.	Standard	7S7SK087010009A21
	4 m	ED	BSB 35-50 Amphenol 2-pol.	High Flex Leder	7S7SH047010009A21
	8 m	ED	BSB 35-50 Amphenol 2-pol.	High Flex Leder	7S7SH087010009A21
ABITIG® 24W	4 m	ED	BSB 35-50 Amphenol 2-pol.	Standard	7S9SK047010009A21
	8 m	ED	BSB 35-50 Amphenol 2-pol.	Standard	7S9SK087010009A21
	4 m	ED	BSB 35-50 Amphenol 2-pol.	High Flex Leder	7S9SH047010009A21
	8 m	ED	BSB 35-50 Amphenol 2-pol.	High Flex Leder	7S9SH087010009A21
ABITIG® 450W	4 m	ED	BSB 35-50 Amphenol 2-pol.	Standard	7T5SK047010109A21
	8 m	ED	BSB 35-50 Amphenol 2-pol.	Standard	7T5SK087010109A21
	4 m	ED	BSB 35-50 Amphenol 2-pol.	High Flex Leder	7T5SH047010109A21
	8 m	ED	BSB 35-50 Amphenol 2-pol.	High Flex Leder	7T5SH087010109A21
ABITIG® 260W	4 m	ED	BSB 35-50 Amphenol 2-pol.	Standard	7T7SK047010109A21
	8 m	ED	BSB 35-50 Amphenol 2-pol.	Standard	7T7SK087010109A21
	4 m	ED	BSB 35-50 Amphenol 2-pol.	High Flex Leder	7T7SH047010109A21
	8 m	ED	BSB 35-50 Amphenol 2-pol.	High Flex Leder	7T7SH087010109A21
ABITIG® 450W SC	4 m	ED	BSB 35-50 Amphenol 2-pol.	Standard	
	8 m	ED	BSB 35-50 Amphenol 2-pol.	Standard	
	4 m	ED	BSB 35-50 Amphenol 2-pol.	High Flex Leder	7T8SH047010109A21
	8 m	ED	BSB 35-50 Amphenol 2-pol.	High Flex Leder	7T8SH087010109A21

ABITIG®-Brennerpreisliste

passend für WIG-Stromquellen des Fabrikates „esab“

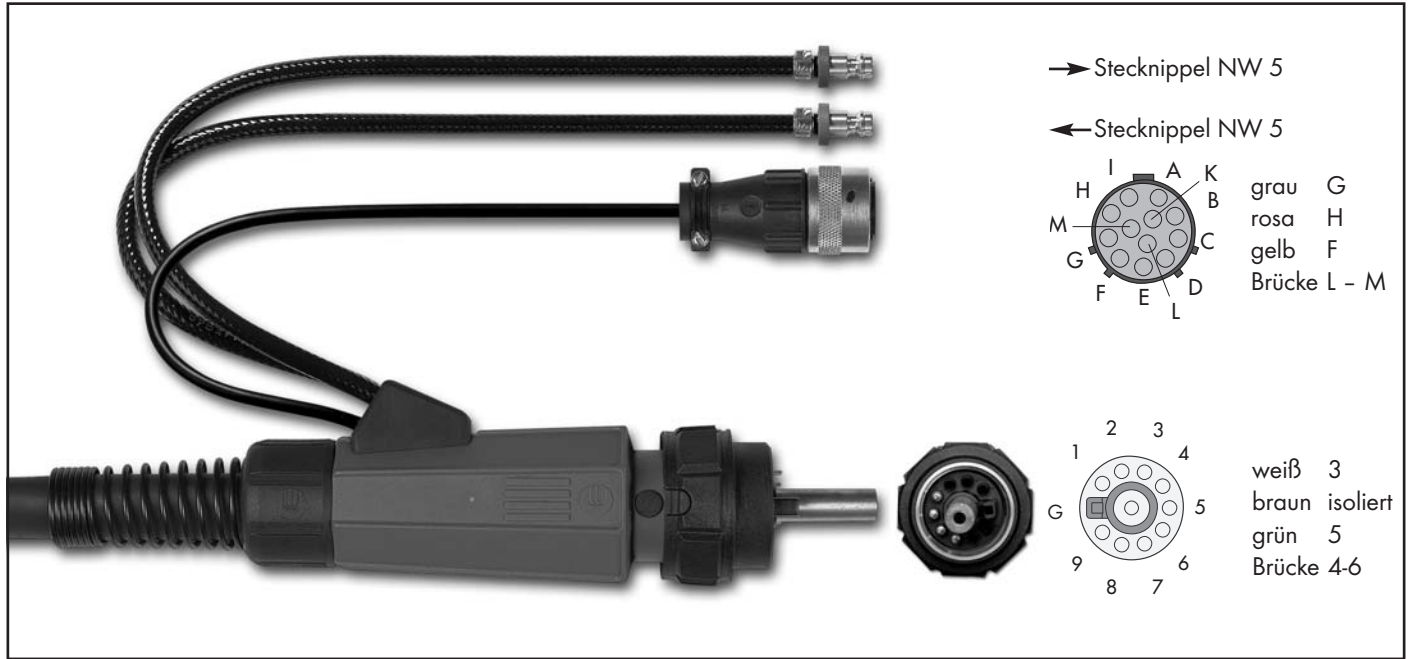

Brennertyp	Länge	Schalterfunktion	maschinenseitiger Anschluss	Schlauchpaketausführung	Bestellnummer
ABITIG® 18	4 m	EDP	ZA 9-pol./Burndy 12-pol.	Standard	7S4SK047040739B12
	8 m	EDP	ZA 9-pol./Burndy 12-pol.	Standard	7S4SK087040739B12
	4 m	EDP	ZA 9-pol./Burndy 12-pol.	High Flex Leder	7S4SH047040739B12
	8 m	EDP	ZA 9-pol./Burndy 12-pol.	High Flex Leder	7S4SH087040739B12
ABITIG® 18F	4 m	EDP	ZA 9-pol./Burndy 12-pol.	Standard	7S4FK047040739B12
	8 m	EDP	ZA 9-pol./Burndy 12-pol.	Standard	7S4FK087040739B12
	4 m	EDP	ZA 9-pol./Burndy 12-pol.	High Flex Leder	7S4FH047040739B12
	8 m	EDP	ZA 9-pol./Burndy 12-pol.	High Flex Leder	7S4FH087040739B12
ABITIG® 20	4 m	EDP	ZA 9-pol./Burndy 12-pol.	Standard	7S5SK047040739B12
	8 m	EDP	ZA 9-pol./Burndy 12-pol.	Standard	7S5SK087040739B12
	4 m	EDP	ZA 9-pol./Burndy 12-pol.	High Flex Leder	7S5SH047040739B12
	8 m	EDP	ZA 9-pol./Burndy 12-pol.	High Flex Leder	7S5SH087040739B12
ABITIG® 20F	4 m	EDP	ZA 9-pol./Burndy 12-pol.	Standard	7S5FK047040739B12
	8 m	EDP	ZA 9-pol./Burndy 12-pol.	Standard	7S5FK087040739B12
	4 m	EDP	ZA 9-pol./Burndy 12-pol.	High Flex Leder	7S5FH047040739B12
	8 m	EDP	ZA 9-pol./Burndy 12-pol.	High Flex Leder	7S5FH087040739B12

Technische Änderungen vorbehalten • Verkaufspreise = unverbindliche Preisempfehlung - Angebot freibleibend • © Copyright

ABITIG®-Brennerpreisliste

passend für WIG-Stromquellen des Fabrikates „esab“

Brennertyp	Länge	Schalterfunktion	maschinenseitiger Anschluss	Schlauchpaketausführung	Bestellnummer
ABITIG® 12-1	4 m	EDP	ZA 9-pol./Burndy 12-pol.	Standard	7S6SK047040739B12
	8 m	EDP	ZA 9-pol./Burndy 12-pol.	Standard	7S6SK087040739B12
	4 m	EDP	ZA 9-pol./Burndy 12-pol.	High Flex Leder	7S6SH047040739B12
	8 m	EDP	ZA 9-pol./Burndy 12-pol.	High Flex Leder	7S6SH087040739B12
ABITIG® 18SC	4 m	EDP	ZA 9-pol./Burndy 12-pol.	Standard	7S7SK047040739B12
	8 m	EDP	ZA 9-pol./Burndy 12-pol.	Standard	7S7SK087040739B12
	4 m	EDP	ZA 9-pol./Burndy 12-pol.	High Flex Leder	7S7SH047040739B12
	8 m	EDP	ZA 9-pol./Burndy 12-pol.	High Flex Leder	7S7SH087040739B12
ABITIG® 24W	4 m	EDP	ZA 9-pol./Burndy 12-pol.	Standard	7S9SK047040739B12
	8 m	EDP	ZA 9-pol./Burndy 12-pol.	Standard	7S9SK087040739B12
	4 m	EDP	ZA 9-pol./Burndy 12-pol.	High Flex Leder	7S9SH047040739B12
	8 m	EDP	ZA 9-pol./Burndy 12-pol.	High Flex Leder	7S9SH087040739B12
ABITIG® 450W	4 m	EDP	ZA 9-pol./Burndy 12-pol.	Standard	7T5SK047040739B12
	8 m	EDP	ZA 9-pol./Burndy 12-pol.	Standard	7T5SK087040739B12
	4 m	EDP	ZA 9-pol./Burndy 12-pol.	High Flex Leder	7T5SH047040739B12
	8 m	EDP	ZA 9-pol./Burndy 12-pol.	High Flex Leder	7T5SH087040739B12
ABITIG® 260W	4 m	EDP	ZA 9-pol./Burndy 12-pol.	Standard	7T7SK047040739B12
	8 m	EDP	ZA 9-pol./Burndy 12-pol.	Standard	7T7SK087040739B12
	4 m	EDP	ZA 9-pol./Burndy 12-pol.	High Flex Leder	7T7SH047040739B12
	8 m	EDP	ZA 9-pol./Burndy 12-pol.	High Flex Leder	7T7SH087040739B12
ABITIG® 450W SC	4 m	EDP	ZA 9-pol./Burndy 12-pol.	Standard	
	8 m	EDP	ZA 9-pol./Burndy 12-pol.	Standard	
	4 m	EDP	ZA 9-pol./Burndy 12-pol.	High Flex Leder	7T8SH047040739B12
	8 m	EDP	ZA 9-pol./Burndy 12-pol.	High Flex Leder	7T8SH087040739B12

ABITIG®-Brennerpreisliste

passend für WIG-Stromquellen des Fabrikates „ess“

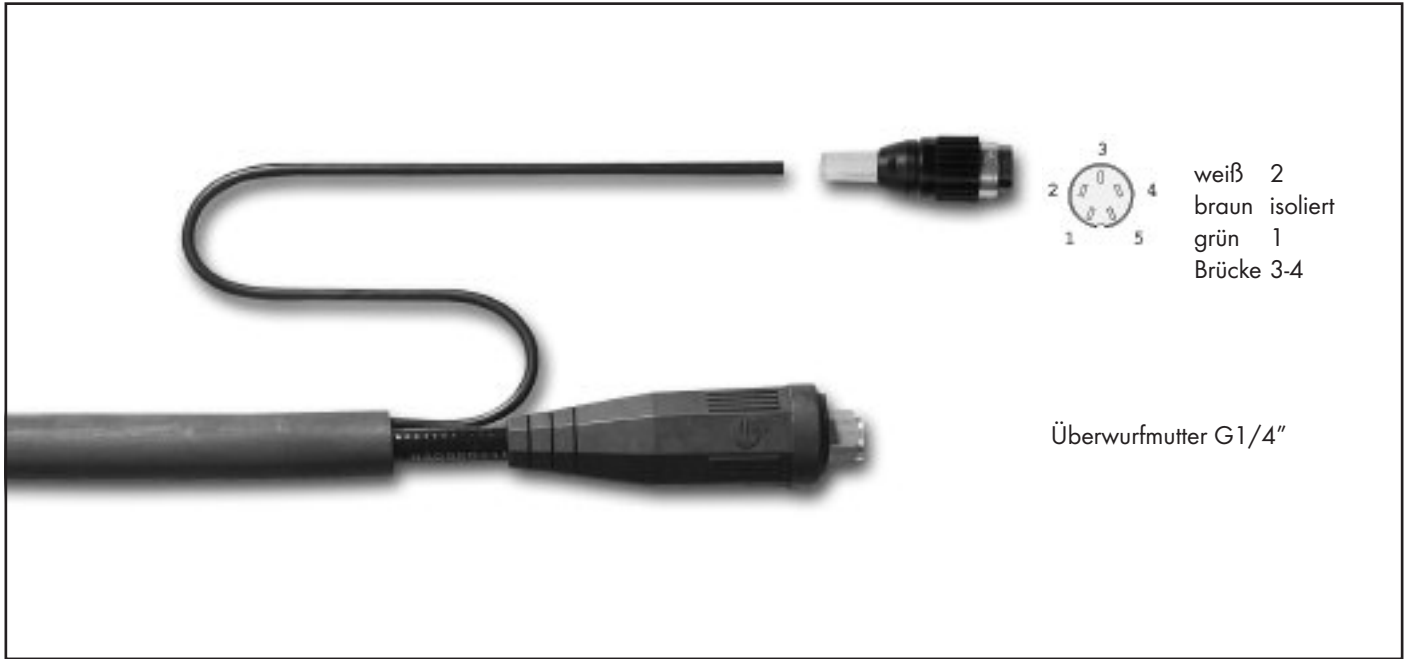

Brennertyp	Länge	Schalterfunktion	maschinenseitiger Anschluss	Schlauchpaketausführung	Bestellnummer
ABITIG® 9	4 m	ED	EA Tuchel 5-pol.	Standard	7S1SK043011106A00
	8 m	ED	EA Tuchel 5-pol.	Standard	7S1SK083011106A00
	4 m	ED	EA Tuchel 5-pol.	High Flex Leder	7S1SH043011106A00
	8 m	ED	EA Tuchel 5-pol.	High Flex Leder	7S1SH083011106A00
ABITIG® 9F	4 m	ED	EA Tuchel 5-pol.	Standard	7S1FK043011106A00
	8 m	ED	EA Tuchel 5-pol.	Standard	7S1FK083011106A00
	4 m	ED	EA Tuchel 5-pol.	High Flex Leder	7S1FH043011106A00
	8 m	ED	EA Tuchel 5-pol.	High Flex Leder	7S1FH083011106A00
ABITIG® 17	4 m	ED	EA Tuchel 5-pol.	Standard	7S2SK043011106A00
	8 m	ED	EA Tuchel 5-pol.	Standard	7S2SK083011106A00
	4 m	ED	EA Tuchel 5-pol.	High Flex Leder	7S2SH043011106A00
	8 m	ED	EA Tuchel 5-pol.	High Flex Leder	7S2SH083011106A00
ABITIG® 17F	4 m	ED	EA Tuchel 5-pol.	Standard	7S2FK043011106A00
	8 m	ED	EA Tuchel 5-pol.	Standard	7S2FK083011106A00
	4 m	ED	EA Tuchel 5-pol.	High Flex Leder	7S2FH043011106A00
	8 m	ED	EA Tuchel 5-pol.	High Flex Leder	7S2FH083011106A00

Technische Änderungen vorbehalten • Verkaufspreise = unverbindliche Preisempfehlung - Angebot freibleibend • © Copyright

ABITIG®-Brennerpreisliste

passend für WIG-Stromquellen des Fabrikates „ess“

Brennertyp	Länge	Schalterfunktion	maschinenseitiger Anschluss	Schlauchpaketausführung	Bestellnummer
ABITIG® 26	4 m	ED	EA Tuchel 5-pol.	Standard	7S3SK043011106A00
	8 m	ED	EA Tuchel 5-pol.	Standard	7S3SK083011106A00
	4 m	ED	EA Tuchel 5-pol.	High Flex Leder	7S3SH043011106A00
	8 m	ED	EA Tuchel 5-pol.	High Flex Leder	7S3SH083011106A00

ABITIG® 26F	4 m	ED	EA Tuchel 5-pol.	Standard	7S3FK043011106A00
	8 m	ED	EA Tuchel 5-pol.	Standard	7S3FK083011106A00
	4 m	ED	EA Tuchel 5-pol.	High Flex Leder	7S3FH043011106A00
	8 m	ED	EA Tuchel 5-pol.	High Flex Leder	7S3FH083011106A00

ABITIG® 24G	4 m	ED	EA Tuchel 5-pol.	Standard	7S8SK043011106A00
	8 m	ED	EA Tuchel 5-pol.	Standard	7S8SK083011106A00
	4 m	ED	EA Tuchel 5-pol.	High Flex Leder	7S8SH043011106A00
	8 m	ED	EA Tuchel 5-pol.	High Flex Leder	7S8SH083011106A00

ABITIG® 200	4 m	ED	EA Tuchel 5-pol.	Standard	7T4SK043011106A00
	8 m	ED	EA Tuchel 5-pol.	Standard	7T4SK083011106A00
	4 m	ED	EA Tuchel 5-pol.	High Flex Leder	7T4SH043011106A00
	8 m	ED	EA Tuchel 5-pol.	High Flex Leder	7T4SH083011106A00

ABITIG® 200F	4 m	ED	EA Tuchel 5-pol.	Standard	7T4FK043011106A00
	8 m	ED	EA Tuchel 5-pol.	Standard	7T4FK083011106A00
	4 m	ED	EA Tuchel 5-pol.	High Flex Leder	7T4FH043011106A00
	8 m	ED	EA Tuchel 5-pol.	High Flex Leder	7T4FH083011106A00

ABITIG® 150	4 m	ED	EA Tuchel 5-pol.	Standard	7T6SK043011106A00
	8 m	ED	EA Tuchel 5-pol.	Standard	7T6SK083011106A00
	4 m	ED	EA Tuchel 5-pol.	High Flex Leder	7T6SH043011106A00
	8 m	ED	EA Tuchel 5-pol.	High Flex Leder	7T6SH083011106A00

ABITIG® 150F	4 m	ED	EA Tuchel 5-pol.	Standard	7T6FK043011106A00
	8 m	ED	EA Tuchel 5-pol.	Standard	7T6FK083011106A00
	4 m	ED	EA Tuchel 5-pol.	High Flex Leder	7T6FH043011106A00
	8 m	ED	EA Tuchel 5-pol.	High Flex Leder	7T6FH083011106A00

ABITIG®-Brennerpreisliste

passend für WIG-Stromquellen des Fabrikates „ess“



Brennertyp	Länge	Schalterfunktion	maschinenseitiger Anschluss	Schlauchpaketausführung	Bestellnummer
ABITIG® 9	4 m	ED	BSB 35-50 Tuchel 5-pol.	Standard	7S1SK043010006A01
	8 m	ED	BSB 35-50 Tuchel 5-pol.	Standard	7S1SK083010006A01
	4 m	ED	BSB 35-50 Tuchel 5-pol.	High Flex Leder	7S1SH043010006A01
	8 m	ED	BSB 35-50 Tuchel 5-pol.	High Flex Leder	7S1SH083010006A01
ABITIG® 9F	4 m	ED	BSB 35-50 Tuchel 5-pol.	Standard	7S1FK043010006A01
	8 m	ED	BSB 35-50 Tuchel 5-pol.	Standard	7S1FK083010006A01
	4 m	ED	BSB 35-50 Tuchel 5-pol.	High Flex Leder	7S1FH043010006A01
	8 m	ED	BSB 35-50 Tuchel 5-pol.	High Flex Leder	7S1FH083010006A01
ABITIG® 17	4 m	ED	BSB 35-50 Tuchel 5-pol.	Standard	7S2SK043010006A01
	8 m	ED	BSB 35-50 Tuchel 5-pol.	Standard	7S2SK083010006A01
	4 m	ED	BSB 35-50 Tuchel 5-pol.	High Flex Leder	7S2SH043010006A01
	8 m	ED	BSB 35-50 Tuchel 5-pol.	High Flex Leder	7S2SH083010006A01
ABITIG® 17F	4 m	ED	BSB 35-50 Tuchel 5-pol.	Standard	7S2FK043010006A01
	8 m	ED	BSB 35-50 Tuchel 5-pol.	Standard	7S2FK083010006A01
	4 m	ED	BSB 35-50 Tuchel 5-pol.	High Flex Leder	7S2FH043010006A01
	8 m	ED	BSB 35-50 Tuchel 5-pol.	High Flex Leder	7S2FH083010006A01

Technische Änderungen vorbehalten • Verkaufspreise = unverbindliche Preisempfehlung - Angebot freibleibend • © Copyright

ABITIG®-Brennerpreisliste

passend für WIG-Stromquellen des Fabrikates „ess“

Brennertyp	Länge	Schalterfunktion	maschinenseitiger Anschluss	Schlauchpaketausführung	Bestellnummer
ABITIG® 26	4 m	ED	BSB 35-50 Tuchel 5-pol.	Standard	7S3SK043010006A01
	8 m	ED	BSB 35-50 Tuchel 5-pol.	Standard	7S3SK083010006A01
	4 m	ED	BSB 35-50 Tuchel 5-pol.	High Flex Leder	7S3SH043010006A01
	8 m	ED	BSB 35-50 Tuchel 5-pol.	High Flex Leder	7S3SH083010006A01
ABITIG® 26F	4 m	ED	BSB 35-50 Tuchel 5-pol.	Standard	7S3FK043010006A01
	8 m	ED	BSB 35-50 Tuchel 5-pol.	Standard	7S3FK083010006A01
	4 m	ED	BSB 35-50 Tuchel 5-pol.	High Flex Leder	7S3FH043010006A01
	8 m	ED	BSB 35-50 Tuchel 5-pol.	High Flex Leder	7S3FH083010006A01
ABITIG® 24G	4 m	ED	BSB 35-50 Tuchel 5-pol.	Standard	7S8SK043010006A01
	8 m	ED	BSB 35-50 Tuchel 5-pol.	Standard	7S8SK083010006A01
	4 m	ED	BSB 35-50 Tuchel 5-pol.	High Flex Leder	7S8SH043010006A01
	8 m	ED	BSB 35-50 Tuchel 5-pol.	High Flex Leder	7S8SH083010006A01
ABITIG® 200	4 m	ED	BSB 35-50 Tuchel 5-pol.	Standard	7T4SK043010006A01
	8 m	ED	BSB 35-50 Tuchel 5-pol.	Standard	7T4SK083010006A01
	4 m	ED	BSB 35-50 Tuchel 5-pol.	High Flex Leder	7T4SH043010006A01
	8 m	ED	BSB 35-50 Tuchel 5-pol.	High Flex Leder	7T4SH083010006A01
ABITIG® 200F	4 m	ED	BSB 35-50 Tuchel 5-pol.	Standard	7T4FK043010006A01
	8 m	ED	BSB 35-50 Tuchel 5-pol.	Standard	7T4FK083010006A01
	4 m	ED	BSB 35-50 Tuchel 5-pol.	High Flex Leder	7T4FH043010006A01
	8 m	ED	BSB 35-50 Tuchel 5-pol.	High Flex Leder	7T4FH083010006A01
ABITIG® 150	4 m	ED	BSB 35-50 Tuchel 5-pol.	Standard	7T6SK043010006A01
	8 m	ED	BSB 35-50 Tuchel 5-pol.	Standard	7T6SK083010006A01
	4 m	ED	BSB 35-50 Tuchel 5-pol.	High Flex Leder	7T6SH043010006A01
	8 m	ED	BSB 35-50 Tuchel 5-pol.	High Flex Leder	7T6SH083010006A01
ABITIG® 150F	4 m	ED	BSB 35-50 Tuchel 5-pol.	Standard	7T6FK043010006A01
	8 m	ED	BSB 35-50 Tuchel 5-pol.	Standard	7T6FK083010006A01
	4 m	ED	BSB 35-50 Tuchel 5-pol.	High Flex Leder	7T6FH043010006A01
	8 m	ED	BSB 35-50 Tuchel 5-pol.	High Flex Leder	7T6FH083010006A01

ABITIG®-Brennerpreisliste

passend für WIG-Stromquellen des Fabrikates „ess“

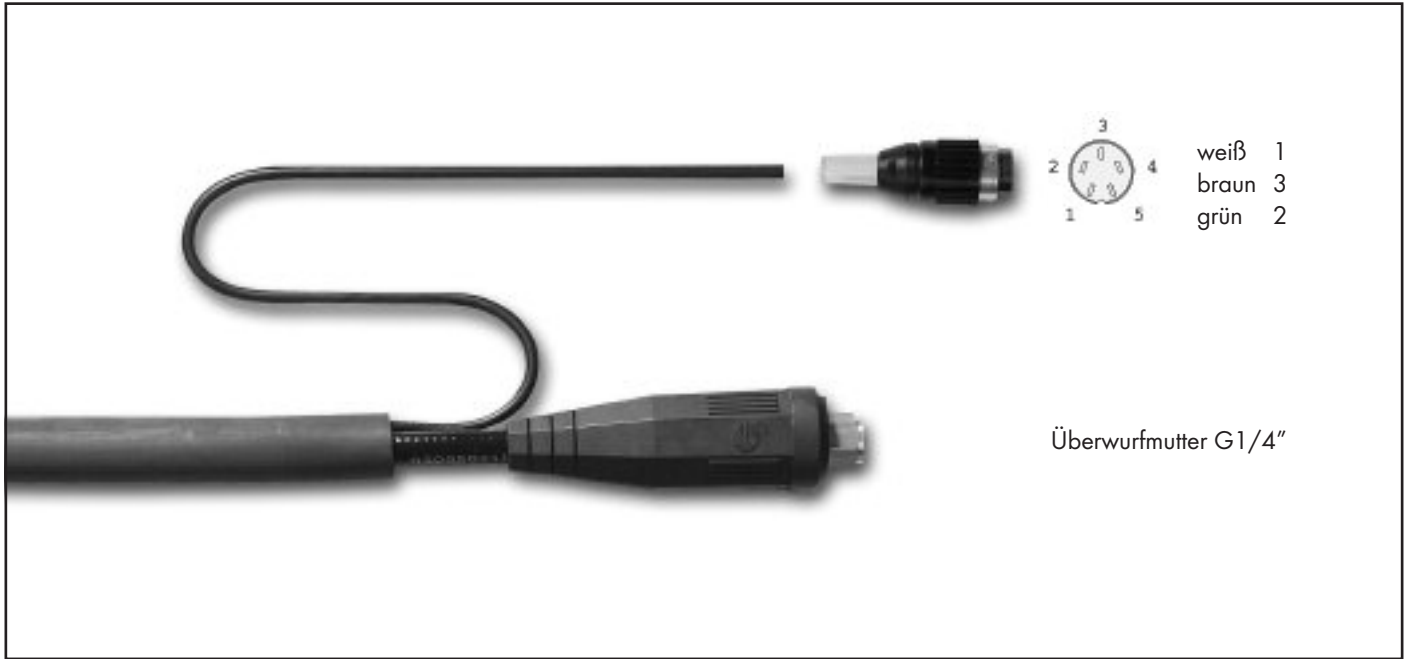

Brennertyp	Länge	Schalterfunktion	maschinenseitiger Anschluss	Schlauchpaketausführung	Bestellnummer
ABITIG® 9	4 m	DD	EA Tuchel 5-pol.	Standard	7S1SK043021101B00
	8 m	DD	EA Tuchel 5-pol.	Standard	7S1SK083021101B00
	4 m	DD	EA Tuchel 5-pol.	High Flex Leder	7S1SH043021101B00
	8 m	DD	EA Tuchel 5-pol.	High Flex Leder	7S1SH083021101B00
ABITIG® 9F	4 m	DD	EA Tuchel 5-pol.	Standard	7S1FK043021101B00
	8 m	DD	EA Tuchel 5-pol.	Standard	7S1FK083021101B00
	4 m	DD	EA Tuchel 5-pol.	High Flex Leder	7S1FH043021101B00
	8 m	DD	EA Tuchel 5-pol.	High Flex Leder	7S1FH083021101B00
ABITIG® 17	4 m	DD	EA Tuchel 5-pol.	Standard	7S2SK043021101B00
	8 m	DD	EA Tuchel 5-pol.	Standard	7S2SK083021101B00
	4 m	DD	EA Tuchel 5-pol.	High Flex Leder	7S2SH043021101B00
	8 m	DD	EA Tuchel 5-pol.	High Flex Leder	7S2SH083021101B00
ABITIG® 17F	4 m	DD	EA Tuchel 5-pol.	Standard	7S2FK043021101B00
	8 m	DD	EA Tuchel 5-pol.	Standard	7S2FK083021101B00
	4 m	DD	EA Tuchel 5-pol.	High Flex Leder	7S2FH043021101B00
	8 m	DD	EA Tuchel 5-pol.	High Flex Leder	7S2FH083021101B00

Technische Änderungen vorbehalten • Verkaufspreise = unverbindliche Preisempfehlung - Angebot freibleibend • © Copyright

ABITIG®-Brennerpreisliste

passend für WIG-Stromquellen des Fabrikates „ess“

Brennertyp	Länge	Schalterfunktion	maschinenseitiger Anschluss	Schlauchpaketausführung	Bestellnummer
ABITIG® 26	4 m	DD	EA Tuchel 5-pol.	Standard	7S3SK043021101B00
	8 m	DD	EA Tuchel 5-pol.	Standard	7S3SK083021101B00
	4 m	DD	EA Tuchel 5-pol.	High Flex Leder	7S3SH043021101B00
	8 m	DD	EA Tuchel 5-pol.	High Flex Leder	7S3SH083021101B00
ABITIG® 26F	4 m	DD	EA Tuchel 5-pol.	Standard	7S3FK043021101B00
	8 m	DD	EA Tuchel 5-pol.	Standard	7S3FK083021101B00
	4 m	DD	EA Tuchel 5-pol.	High Flex Leder	7S3FH043021101B00
	8 m	DD	EA Tuchel 5-pol.	High Flex Leder	7S3FH083021101B00
ABITIG® 24G	4 m	DD	EA Tuchel 5-pol.	Standard	7S8SK043021101B00
	8 m	DD	EA Tuchel 5-pol.	Standard	7S8SK083021101B00
	4 m	DD	EA Tuchel 5-pol.	High Flex Leder	7S8SH043021101B00
	8 m	DD	EA Tuchel 5-pol.	High Flex Leder	7S8SH083021101B00
ABITIG® 200	4 m	DD	EA Tuchel 5-pol.	Standard	7T4SK043021101B00
	8 m	DD	EA Tuchel 5-pol.	Standard	7T4SK083021101B00
	4 m	DD	EA Tuchel 5-pol.	High Flex Leder	7T4SH043021101B00
	8 m	DD	EA Tuchel 5-pol.	High Flex Leder	7T4SH083021101B00
ABITIG® 200F	4 m	DD	EA Tuchel 5-pol.	Standard	7T4FK043021101B00
	8 m	DD	EA Tuchel 5-pol.	Standard	7T4FK083021101B00
	4 m	DD	EA Tuchel 5-pol.	High Flex Leder	7T4FH043021101B00
	8 m	DD	EA Tuchel 5-pol.	High Flex Leder	7T4FH083021101B00
ABITIG® 150	4 m	DD	EA Tuchel 5-pol.	Standard	7T6SK043021101B00
	8 m	DD	EA Tuchel 5-pol.	Standard	7T6SK083021101B00
	4 m	DD	EA Tuchel 5-pol.	High Flex Leder	7T6SH043021101B00
	8 m	DD	EA Tuchel 5-pol.	High Flex Leder	7T6SH083021101B00
ABITIG® 150F	4 m	DD	EA Tuchel 5-pol.	Standard	7T6FK043021101B00
	8 m	DD	EA Tuchel 5-pol.	Standard	7T6FK083021101B00
	4 m	DD	EA Tuchel 5-pol.	High Flex Leder	7T6FH043021101B00
	8 m	DD	EA Tuchel 5-pol.	High Flex Leder	7T6FH083021101B00

ABITIG®-Brennerpreisliste

passend für WIG-Stromquellen des Fabrikates „ess“



Brennertyp	Länge	Schalterfunktion	maschinenseitiger Anschluss	Schlauchpaketausführung	Bestellnummer
ABITIG® 9	4 m	DD	BSB 35-50 Tuchel 5-pol.	Standard	7S1SK043020001B01
	8 m	DD	BSB 35-50 Tuchel 5-pol.	Standard	7S1SK083020001B01
	4 m	DD	BSB 35-50 Tuchel 5-pol.	High Flex Leder	7S1SH043020001B01
	8 m	DD	BSB 35-50 Tuchel 5-pol.	High Flex Leder	7S1SH083020001B01

ABITIG® 9F	4 m	DD	BSB 35-50 Tuchel 5-pol.	Standard	7S1FK043020001B01
	8 m	DD	BSB 35-50 Tuchel 5-pol.	Standard	7S1FK083020001B01
	4 m	DD	BSB 35-50 Tuchel 5-pol.	High Flex Leder	7S1FH043020001B01
	8 m	DD	BSB 35-50 Tuchel 5-pol.	High Flex Leder	7S1FH083020001B01

ABITIG® 17	4 m	DD	BSB 35-50 Tuchel 5-pol.	Standard	7S2SK043020001B01
	8 m	DD	BSB 35-50 Tuchel 5-pol.	Standard	7S2SK083020001B01
	4 m	DD	BSB 35-50 Tuchel 5-pol.	High Flex Leder	7S2SH043020001B01
	8 m	DD	BSB 35-50 Tuchel 5-pol.	High Flex Leder	7S2SH083020001B01

ABITIG® 17F	4 m	DD	BSB 35-50 Tuchel 5-pol.	Standard	7S2FK043020001B01
	8 m	DD	BSB 35-50 Tuchel 5-pol.	Standard	7S2FK083020001B01
	4 m	DD	BSB 35-50 Tuchel 5-pol.	High Flex Leder	7S2FH043020001B01
	8 m	DD	BSB 35-50 Tuchel 5-pol.	High Flex Leder	7S2FH083020001B01

Technische Änderungen vorbehalten • Verkaufspreise = unverbindliche Preisempfehlung - Angebot freibleibend • © Copyright

ABITIG®-Brennerpreisliste

passend für WIG-Stromquellen des Fabrikates „ess“

Brennertyp	Länge	Schalterfunktion	maschinenseitiger Anschluss	Schlauchpaketausführung	Bestellnummer
ABITIG® 26	4 m	DD	BSB 35-50 Tuchel 5-pol.	Standard	7S3SK043020001B01
	8 m	DD	BSB 35-50 Tuchel 5-pol.	Standard	7S3SK083020001B01
	4 m	DD	BSB 35-50 Tuchel 5-pol.	High Flex Leder	7S3SH043020001B01
	8 m	DD	BSB 35-50 Tuchel 5-pol.	High Flex Leder	7S3SH083020001B01
ABITIG® 26F	4 m	DD	BSB 35-50 Tuchel 5-pol.	Standard	7S3FK043020001B01
	8 m	DD	BSB 35-50 Tuchel 5-pol.	Standard	7S3FK083020001B01
	4 m	DD	BSB 35-50 Tuchel 5-pol.	High Flex Leder	7S3FH043020001B01
	8 m	DD	BSB 35-50 Tuchel 5-pol.	High Flex Leder	7S3FH083020001B01
ABITIG® 24G	4 m	DD	BSB 35-50 Tuchel 5-pol.	Standard	7S8SK043020001B01
	8 m	DD	BSB 35-50 Tuchel 5-pol.	Standard	7S8SK083020001B01
	4 m	DD	BSB 35-50 Tuchel 5-pol.	High Flex Leder	7S8SH043020001B01
	8 m	DD	BSB 35-50 Tuchel 5-pol.	High Flex Leder	7S8SH083020001B01
ABITIG® 200	4 m	DD	BSB 35-50 Tuchel 5-pol.	Standard	7T4SK043020001B01
	8 m	DD	BSB 35-50 Tuchel 5-pol.	Standard	7T4SK083020001B01
	4 m	DD	BSB 35-50 Tuchel 5-pol.	High Flex Leder	7T4SH043020001B01
	8 m	DD	BSB 35-50 Tuchel 5-pol.	High Flex Leder	7T4SH083020001B01
ABITIG® 200F	4 m	DD	BSB 35-50 Tuchel 5-pol.	Standard	7T4FK043020001B01
	8 m	DD	BSB 35-50 Tuchel 5-pol.	Standard	7T4FK083020001B01
	4 m	DD	BSB 35-50 Tuchel 5-pol.	High Flex Leder	7T4FH043020001B01
	8 m	DD	BSB 35-50 Tuchel 5-pol.	High Flex Leder	7T4FH083020001B01
ABITIG® 150	4 m	DD	BSB 35-50 Tuchel 5-pol.	Standard	7T6SK043020001B01
	8 m	DD	BSB 35-50 Tuchel 5-pol.	Standard	7T6SK083020001B01
	4 m	DD	BSB 35-50 Tuchel 5-pol.	High Flex Leder	7T6SH043020001B01
	8 m	DD	BSB 35-50 Tuchel 5-pol.	High Flex Leder	7T6SH083020001B01
ABITIG® 150F	4 m	DD	BSB 35-50 Tuchel 5-pol.	Standard	7T6FK043020001B01
	8 m	DD	BSB 35-50 Tuchel 5-pol.	Standard	7T6FK083020001B01
	4 m	DD	BSB 35-50 Tuchel 5-pol.	High Flex Leder	7T6FH043020001B01
	8 m	DD	BSB 35-50 Tuchel 5-pol.	High Flex Leder	7T6FH083020001B01

ABITIG®-Brennerpreisliste

passend für WIG-Stromquellen des Fabrikates „ess“

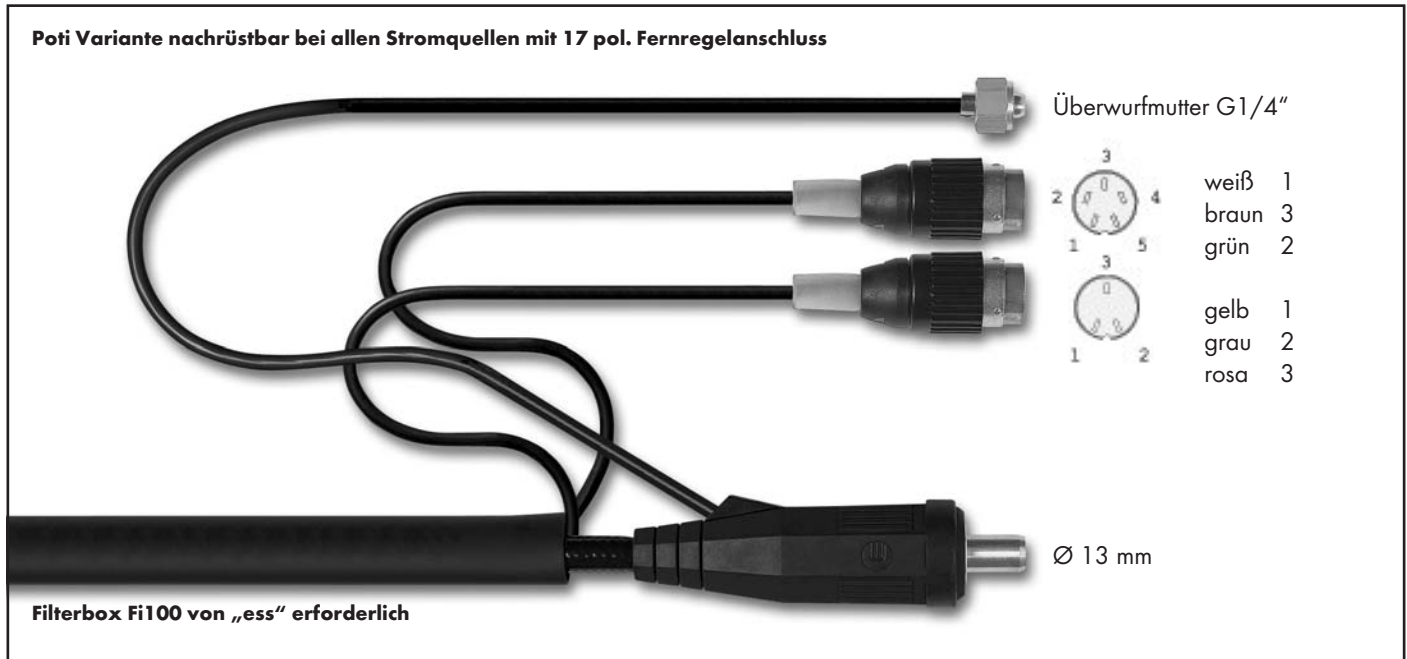

Brennertyp	Länge	Schalterfunktion	maschinenseitiger Anschluss	Schlauchpaketausführung	Bestellnummer
ABITIG® 9	4 m	DDP	BSB 35-50 Tuchel 5-pol./3-pol.	Standard	7S1SK046040052A01
	8 m	DDP	BSB 35-50 Tuchel 5-pol./3-pol.	Standard	7S1SK086040052A01
	4 m	DDP	BSB 35-50 Tuchel 5-pol./3-pol.	High Flex Leder	7S1SH046040052A01
	8 m	DDP	BSB 35-50 Tuchel 5-pol./3-pol.	High Flex Leder	7S1SH086040052A01
ABITIG® 9F	4 m	DDP	BSB 35-50 Tuchel 5-pol./3-pol.	Standard	7S1FK046040052A01
	8 m	DDP	BSB 35-50 Tuchel 5-pol./3-pol.	Standard	7S1FK086040052A01
	4 m	DDP	BSB 35-50 Tuchel 5-pol./3-pol.	High Flex Leder	7S1FH046040052A01
	8 m	DDP	BSB 35-50 Tuchel 5-pol./3-pol.	High Flex Leder	7S1FH086040052A01
ABITIG® 17	4 m	DDP	BSB 35-50 Tuchel 5-pol./3-pol.	Standard	7S2SK046040052A01
	8 m	DDP	BSB 35-50 Tuchel 5-pol./3-pol.	Standard	7S2SK086040052A01
	4 m	DDP	BSB 35-50 Tuchel 5-pol./3-pol.	High Flex Leder	7S2SH046040052A01
	8 m	DDP	BSB 35-50 Tuchel 5-pol./3-pol.	High Flex Leder	7S2SH086040052A01
ABITIG® 17F	4 m	DDP	BSB 35-50 Tuchel 5-pol./3-pol.	Standard	7S2FK046040052A01
	8 m	DDP	BSB 35-50 Tuchel 5-pol./3-pol.	Standard	7S2FK086040052A01
	4 m	DDP	BSB 35-50 Tuchel 5-pol./3-pol.	High Flex Leder	7S2FH046040052A01
	8 m	DDP	BSB 35-50 Tuchel 5-pol./3-pol.	High Flex Leder	7S2FH086040052A01

Technische Änderungen vorbehalten • Verkaufspreise = unverbindliche Preisempfehlung - Angebot freibleibend • © Copyright

ABITIG®-Brennerpreisliste

passend für WIG-Stromquellen des Fabrikates „ess“

Brennertyp	Länge	Schalterfunktion	maschinenseitiger Anschluss	Schlauchpaketausführung	Bestellnummer
ABITIG® 26	4 m	DDP	BSB 35-50 Tuchel 5-pol./3-pol.	Standard	7S3SK046040052A01
	8 m	DDP	BSB 35-50 Tuchel 5-pol./3-pol.	Standard	7S3SK086040052A01
	4 m	DDP	BSB 35-50 Tuchel 5-pol./3-pol.	High Flex Leder	7S3SH046040052A01
	8 m	DDP	BSB 35-50 Tuchel 5-pol./3-pol.	High Flex Leder	7S3SH086040052A01

ABITIG® 26F	4 m	DDP	BSB 35-50 Tuchel 5-pol./3-pol.	Standard	7S3FK046040052A01
	8 m	DDP	BSB 35-50 Tuchel 5-pol./3-pol.	Standard	7S3FK086040052A01
	4 m	DDP	BSB 35-50 Tuchel 5-pol./3-pol.	High Flex Leder	7S3FH046040052A01
	8 m	DDP	BSB 35-50 Tuchel 5-pol./3-pol.	High Flex Leder	7S3FH086040052A01

ABITIG® 24G	4 m	DDP	BSB 35-50 Tuchel 5-pol./3-pol.	Standard	7S8SK046040052A01
	8 m	DDP	BSB 35-50 Tuchel 5-pol./3-pol.	Standard	7S8SK086040052A01
	4 m	DDP	BSB 35-50 Tuchel 5-pol./3-pol.	High Flex Leder	7S8SH046040052A01
	8 m	DDP	BSB 35-50 Tuchel 5-pol./3-pol.	High Flex Leder	7S8SH086040052A01

ABITIG® 200	4 m	DDP	BSB 35-50 Tuchel 5-pol./3-pol.	Standard	7T4SK046040052A01
	8 m	DDP	BSB 35-50 Tuchel 5-pol./3-pol.	Standard	7T4SK086040052A01
	4 m	DDP	BSB 35-50 Tuchel 5-pol./3-pol.	High Flex Leder	7T4SH046040052A01
	8 m	DDP	BSB 35-50 Tuchel 5-pol./3-pol.	High Flex Leder	7T4SH086040052A01

ABITIG® 200F	4 m	DDP	BSB 35-50 Tuchel 5-pol./3-pol.	Standard	7T4FK046040052A01
	8 m	DDP	BSB 35-50 Tuchel 5-pol./3-pol.	Standard	7T4FK086040052A01
	4 m	DDP	BSB 35-50 Tuchel 5-pol./3-pol.	High Flex Leder	7T4FH046040052A01
	8 m	DDP	BSB 35-50 Tuchel 5-pol./3-pol.	High Flex Leder	7T4FH086040052A01

ABITIG® 150	4 m	DDP	BSB 35-50 Tuchel 5-pol./3-pol.	Standard	7T6SK046040052A01
	8 m	DDP	BSB 35-50 Tuchel 5-pol./3-pol.	Standard	7T6SK086040052A01
	4 m	DDP	BSB 35-50 Tuchel 5-pol./3-pol.	High Flex Leder	7T6SH046040052A01
	8 m	DDP	BSB 35-50 Tuchel 5-pol./3-pol.	High Flex Leder	7T6SH086040052A01

ABITIG® 150F	4 m	DDP	BSB 35-50 Tuchel 5-pol./3-pol.	Standard	7T6FK046040052A01
	8 m	DDP	BSB 35-50 Tuchel 5-pol./3-pol.	Standard	7T6FK086040052A01
	4 m	DDP	BSB 35-50 Tuchel 5-pol./3-pol.	High Flex Leder	7T6FH046040052A01
	8 m	DDP	BSB 35-50 Tuchel 5-pol./3-pol.	High Flex Leder	7T6FH086040052A01

ABITIG®-Brennerpreisliste

passend für WIG-Stromquellen des Fabrikates „ess“

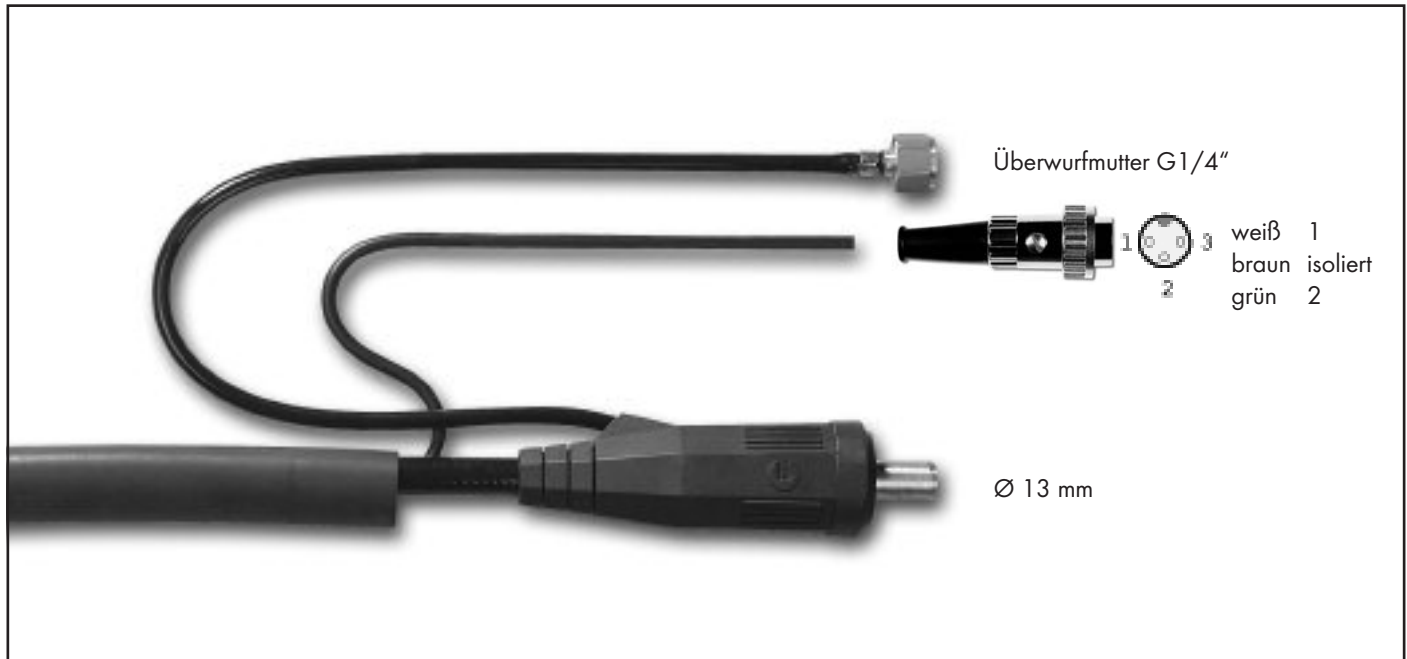

Brennertyp	Länge	Schalterfunktion	maschinenseitiger Anschluss	Schlauchpaketausführung	Bestellnummer
ABITIG® 9	4 m	ED	BSB 35-50 / Dioden-Stecker 3-pol.	Standard	7S1SK043010024A01
	8 m	ED	BSB 35-50 / Dioden-Stecker 3-pol.	Standard	7S1SK083010024A01
	4 m	ED	BSB 35-50 / Dioden-Stecker 3-pol.	High Flex Leder	7S1SH043010024A01
	8 m	ED	BSB 35-50 / Dioden-Stecker 3-pol.	High Flex Leder	7S1SH083010024A01

ABITIG® 9F	4 m	ED	BSB 35-50 / Dioden-Stecker 3-pol.	Standard	7S1FK043010024A01
	8 m	ED	BSB 35-50 / Dioden-Stecker 3-pol.	Standard	7S1FK083010024A01
	4 m	ED	BSB 35-50 / Dioden-Stecker 3-pol.	High Flex Leder	7S1FH043010024A01
	8 m	ED	BSB 35-50 / Dioden-Stecker 3-pol.	High Flex Leder	7S1FH083010024A01

ABITIG® 17	4 m	ED	BSB 35-50 / Dioden-Stecker 3-pol.	Standard	7S2SK043010024A01
	8 m	ED	BSB 35-50 / Dioden-Stecker 3-pol.	Standard	7S2SK083010024A01
	4 m	ED	BSB 35-50 / Dioden-Stecker 3-pol.	High Flex Leder	7S2SH043010024A01
	8 m	ED	BSB 35-50 / Dioden-Stecker 3-pol.	High Flex Leder	7S2SH083010024A01

ABITIG® 17F	4 m	ED	BSB 35-50 / Dioden-Stecker 3-pol.	Standard	7S2FK043010024A01
	8 m	ED	BSB 35-50 / Dioden-Stecker 3-pol.	Standard	7S2FK083010024A01
	4 m	ED	BSB 35-50 / Dioden-Stecker 3-pol.	High Flex Leder	7S2FH043010024A01
	8 m	ED	BSB 35-50 / Dioden-Stecker 3-pol.	High Flex Leder	7S2FH083010024A01

Technische Änderungen vorbehalten • Verkaufspreise = unverbindliche Preisempfehlung - Angebot freibleibend • © Copyright

ABITIG®-Brennerpreisliste

passend für WIG-Stromquellen des Fabrikates „ess“

Brennertyp	Länge	Schalterfunktion	maschinenseitiger Anschluss	Schlauchpaketausführung	Bestellnummer
ABITIG® 26	4 m	ED	BSB 35-50 / Dioden-Stecker 3-pol.	Standard	7S3SK043010024A01
	8 m	ED	BSB 35-50 / Dioden-Stecker 3-pol.	Standard	7S3SK083010024A01
	4 m	ED	BSB 35-50 / Dioden-Stecker 3-pol.	High Flex Leder	7S3SH043010024A01
	8 m	ED	BSB 35-50 / Dioden-Stecker 3-pol.	High Flex Leder	7S3SH083010024A01
ABITIG® 26F	4 m	ED	BSB 35-50 / Dioden-Stecker 3-pol.	Standard	7S3FK043010024A01
	8 m	ED	BSB 35-50 / Dioden-Stecker 3-pol.	Standard	7S3FK083010024A01
	4 m	ED	BSB 35-50 / Dioden-Stecker 3-pol.	High Flex Leder	7S3FH043010024A01
	8 m	ED	BSB 35-50 / Dioden-Stecker 3-pol.	High Flex Leder	7S3FH083010024A01
ABITIG® 24G	4 m	ED	BSB 35-50 / Dioden-Stecker 3-pol.	Standard	7S8SK043010024A01
	8 m	ED	BSB 35-50 / Dioden-Stecker 3-pol.	Standard	7S8SK083010024A01
	4 m	ED	BSB 35-50 / Dioden-Stecker 3-pol.	High Flex Leder	7S8SH043010024A01
	8 m	ED	BSB 35-50 / Dioden-Stecker 3-pol.	High Flex Leder	7S8SH083010024A01
ABITIG® 200	4 m	ED	BSB 35-50 / Dioden-Stecker 3-pol.	Standard	7T4SK043010024A01
	8 m	ED	BSB 35-50 / Dioden-Stecker 3-pol.	Standard	7T4SK083010024A01
	4 m	ED	BSB 35-50 / Dioden-Stecker 3-pol.	High Flex Leder	7T4SH043010024A01
	8 m	ED	BSB 35-50 / Dioden-Stecker 3-pol.	High Flex Leder	7T4SH083010024A01
ABITIG® 200F	4 m	ED	BSB 35-50 / Dioden-Stecker 3-pol.	Standard	7T4FK043010024A01
	8 m	ED	BSB 35-50 / Dioden-Stecker 3-pol.	Standard	7T4FK083010024A01
	4 m	ED	BSB 35-50 / Dioden-Stecker 3-pol.	High Flex Leder	7T4FH043010024A01
	8 m	ED	BSB 35-50 / Dioden-Stecker 3-pol.	High Flex Leder	7T4FH083010024A01
ABITIG® 150	4 m	ED	BSB 35-50 / Dioden-Stecker 3-pol.	Standard	7T6SK043010024A01
	8 m	ED	BSB 35-50 / Dioden-Stecker 3-pol.	Standard	7T6SK083010024A01
	4 m	ED	BSB 35-50 / Dioden-Stecker 3-pol.	High Flex Leder	7T6SH043010024A01
	8 m	ED	BSB 35-50 / Dioden-Stecker 3-pol.	High Flex Leder	7T6SH083010024A01
ABITIG® 150F	4 m	ED	BSB 35-50 / Dioden-Stecker 3-pol.	Standard	7T6FK043010024A01
	8 m	ED	BSB 35-50 / Dioden-Stecker 3-pol.	Standard	7T6FK083010024A01
	4 m	ED	BSB 35-50 / Dioden-Stecker 3-pol.	High Flex Leder	7T6FH043010024A01
	8 m	ED	BSB 35-50 / Dioden-Stecker 3-pol.	High Flex Leder	7T6FH083010024A01

ABITIG®-Brennerpreisliste

passend für WIG-Stromquellen des Fabrikates „ess“



Brennertyp	Länge	Schalterfunktion	maschinenseitiger Anschluss	Schlauchpaketausführung	Bestellnummer
ABITIG® 9	4 m	DD	BSB 35-50 Tuchel 5-pol.	Standard	7S1SK043020001B05
	8 m	DD	BSB 35-50 Tuchel 5-pol.	Standard	7S1SK083020001B05
	4 m	DD	BSB 35-50 Tuchel 5-pol.	High Flex Leder	7S1SH043020001B05
	8 m	DD	BSB 35-50 Tuchel 5-pol.	High Flex Leder	7S1SH083020001B05

ABITIG® 9F	4 m	DD	BSB 35-50 Tuchel 5-pol.	Standard	7S1FK043020001B05
	8 m	DD	BSB 35-50 Tuchel 5-pol.	Standard	7S1FK083020001B05
	4 m	DD	BSB 35-50 Tuchel 5-pol.	High Flex Leder	7S1FH043020001B05
	8 m	DD	BSB 35-50 Tuchel 5-pol.	High Flex Leder	7S1FH083020001B05

ABITIG® 17	4 m	DD	BSB 35-50 Tuchel 5-pol.	Standard	7S2SK043020001B05
	8 m	DD	BSB 35-50 Tuchel 5-pol.	Standard	7S2SK083020001B05
	4 m	DD	BSB 35-50 Tuchel 5-pol.	High Flex Leder	7S2SH043020001B05
	8 m	DD	BSB 35-50 Tuchel 5-pol.	High Flex Leder	7S2SH083020001B05

ABITIG® 17F	4 m	DD	BSB 35-50 Tuchel 5-pol.	Standard	7S2FK043020001B05
	8 m	DD	BSB 35-50 Tuchel 5-pol.	Standard	7S2FK083020001B05
	4 m	DD	BSB 35-50 Tuchel 5-pol.	High Flex Leder	7S2FH043020001B05
	8 m	DD	BSB 35-50 Tuchel 5-pol.	High Flex Leder	7S2FH083020001B05

Technische Änderungen vorbehalten • Verkaufspreise = unverbindliche Preisempfehlung - Angebot freibleibend • © Copyright

ABITIG®-Brennerpreisliste

passend für WIG-Stromquellen des Fabrikates „ess“

Brennertyp	Länge	Schalterfunktion	maschinenseitiger Anschluss	Schlauchpaketausführung	Bestellnummer
ABITIG® 26	4 m	DD	BSB 35-50 Tuchel 5-pol.	Standard	7S3SK043020001B05
	8 m	DD	BSB 35-50 Tuchel 5-pol.	Standard	7S3SK083020001B05
	4 m	DD	BSB 35-50 Tuchel 5-pol.	High Flex Leder	7S3SH043020001B05
	8 m	DD	BSB 35-50 Tuchel 5-pol.	High Flex Leder	7S3SH083020001B05
<hr/>					
ABITIG® 26F	4 m	DD	BSB 35-50 Tuchel 5-pol.	Standard	7S3FK043020001B05
	8 m	DD	BSB 35-50 Tuchel 5-pol.	Standard	7S3FK083020001B05
	4 m	DD	BSB 35-50 Tuchel 5-pol.	High Flex Leder	7S3FH043020001B05
	8 m	DD	BSB 35-50 Tuchel 5-pol.	High Flex Leder	7S3FH083020001B05
<hr/>					
ABITIG® 24G	4 m	DD	BSB 35-50 Tuchel 5-pol.	Standard	7S8SK043020001B05
	8 m	DD	BSB 35-50 Tuchel 5-pol.	Standard	7S8SK083020001B05
	4 m	DD	BSB 35-50 Tuchel 5-pol.	High Flex Leder	7S8SH043020001B05
	8 m	DD	BSB 35-50 Tuchel 5-pol.	High Flex Leder	7S8SH083020001B05
<hr/>					
ABITIG® 200	4 m	DD	BSB 35-50 Tuchel 5-pol.	Standard	7T4SK043020001B05
	8 m	DD	BSB 35-50 Tuchel 5-pol.	Standard	7T4SK083020001B05
	4 m	DD	BSB 35-50 Tuchel 5-pol.	High Flex Leder	7T4SH043020001B05
	8 m	DD	BSB 35-50 Tuchel 5-pol.	High Flex Leder	7T4SH083020001B05
<hr/>					
ABITIG® 200F	4 m	DD	BSB 35-50 Tuchel 5-pol.	Standard	7T4FK043020001B05
	8 m	DD	BSB 35-50 Tuchel 5-pol.	Standard	7T4FK083020001B05
	4 m	DD	BSB 35-50 Tuchel 5-pol.	High Flex Leder	7T4FH043020001B05
	8 m	DD	BSB 35-50 Tuchel 5-pol.	High Flex Leder	7T4FH083020001B05
<hr/>					
ABITIG® 150	4 m	DD	BSB 35-50 Tuchel 5-pol.	Standard	7T6SK043020001B05
	8 m	DD	BSB 35-50 Tuchel 5-pol.	Standard	7T6SK083020001B05
	4 m	DD	BSB 35-50 Tuchel 5-pol.	High Flex Leder	7T6SH043020001B05
	8 m	DD	BSB 35-50 Tuchel 5-pol.	High Flex Leder	7T6SH083020001B05
<hr/>					
ABITIG® 150F	4 m	DD	BSB 35-50 Tuchel 5-pol.	Standard	7T6FK043020001B05
	8 m	DD	BSB 35-50 Tuchel 5-pol.	Standard	7T6FK083020001B05
	4 m	DD	BSB 35-50 Tuchel 5-pol.	High Flex Leder	7T6FH043020001B05
	8 m	DD	BSB 35-50 Tuchel 5-pol.	High Flex Leder	7T6FH083020001B05

ABITIG®-Brennerpreisliste

passend für WIG-Stromquellen des Fabrikates „ess“



Brennertyp	Länge	Schalterfunktion	maschinenseitiger Anschluss	Schlauchpaketausführung	Bestellnummer
ABITIG® 18	4 m	ED	EA Tuchel 5-pol.	Standard	7S4SK043010802A15
	8 m	ED	EA Tuchel 5-pol.	Standard	7S4SK083010802A15
	4 m	ED	EA Tuchel 5-pol.	High Flex Leder	7S4SH043010802A15
	8 m	ED	EA Tuchel 5-pol.	High Flex Leder	7S4SH083010802A15
ABITIG® 18F	4 m	ED	EA Tuchel 5-pol.	Standard	7S4FK043010802A15
	8 m	ED	EA Tuchel 5-pol.	Standard	7S4FK083010802A15
	4 m	ED	EA Tuchel 5-pol.	High Flex Leder	7S4FH043010802A15
	8 m	ED	EA Tuchel 5-pol.	High Flex Leder	7S4FH083010802A15
ABITIG® 20	4 m	ED	EA Tuchel 5-pol.	Standard	7S5SK043010802A15
	8 m	ED	EA Tuchel 5-pol.	Standard	7S5SK083010802A15
	4 m	ED	EA Tuchel 5-pol.	High Flex Leder	7S5SH043010802A15
	8 m	ED	EA Tuchel 5-pol.	High Flex Leder	7S5SH083010802A15
ABITIG® 20F	4 m	ED	EA Tuchel 5-pol.	Standard	7S5FK043010802A15
	8 m	ED	EA Tuchel 5-pol.	Standard	7S5FK083010802A15
	4 m	ED	EA Tuchel 5-pol.	High Flex Leder	7S5FH043010802A15
	8 m	ED	EA Tuchel 5-pol.	High Flex Leder	7S5FH083010802A15

Technische Änderungen vorbehalten • Verkaufspreise = unverbindliche Preisempfehlung - Angebot freibleibend • © Copyright

ABITIG®-Brennerpreisliste

passend für WIG-Stromquellen des Fabrikates „ess“

Brennertyp	Länge	Schalterfunktion	maschinenseitiger Anschluss	Schlauchpaketausführung	Bestellnummer
ABITIG® 12-1	4 m	ED	EA Tuchel 5-pol.	Standard	7S6SK043010802A15
	8 m	ED	EA Tuchel 5-pol.	Standard	7S6SK083010802A15
	4 m	ED	EA Tuchel 5-pol.	High Flex Leder	7S6SH043010802A15
	8 m	ED	EA Tuchel 5-pol.	High Flex Leder	7S6SH083010802A15
ABITIG® 18SC	4 m	ED	EA Tuchel 5-pol.	Standard	7S7SK043010802A15
	8 m	ED	EA Tuchel 5-pol.	Standard	7S7SK083010802A15
	4 m	ED	EA Tuchel 5-pol.	High Flex Leder	7S7SH043010802A15
	8 m	ED	EA Tuchel 5-pol.	High Flex Leder	7S7SH083010802A15
ABITIG® 24W	4 m	ED	EA Tuchel 5-pol.	Standard	7S9SK043010802A15
	8 m	ED	EA Tuchel 5-pol.	Standard	7S9SK083010802A15
	4 m	ED	EA Tuchel 5-pol.	High Flex Leder	7S9SH043010802A15
	8 m	ED	EA Tuchel 5-pol.	High Flex Leder	7S9SH083010802A15
ABITIG® 450W	4 m	ED	EA Tuchel 5-pol.	Standard	7T5SK043010802A15
	8 m	ED	EA Tuchel 5-pol.	Standard	7T5SK083010802A15
	4 m	ED	EA Tuchel 5-pol.	High Flex Leder	7T5SH043010802A15
	8 m	ED	EA Tuchel 5-pol.	High Flex Leder	7T5SH083010802A15
ABITIG® 260W	4 m	ED	EA Tuchel 5-pol.	Standard	7T7SK043010802A15
	8 m	ED	EA Tuchel 5-pol.	Standard	7T7SK083010802A15
	4 m	ED	EA Tuchel 5-pol.	High Flex Leder	7T7SH043010802A15
	8 m	ED	EA Tuchel 5-pol.	High Flex Leder	7T7SH083010802A15
ABITIG® 450W SC	4 m	ED	EA Tuchel 5-pol.	Standard	
	8 m	ED	EA Tuchel 5-pol.	Standard	
	4 m	ED	EA Tuchel 5-pol.	High Flex Leder	7T8SH043010802A15
	8 m	ED	EA Tuchel 5-pol.	High Flex Leder	7T8SH083010802A15

ABITIG®-Brennerpreisliste

passend für WIG-Stromquellen des Fabrikates „ess“

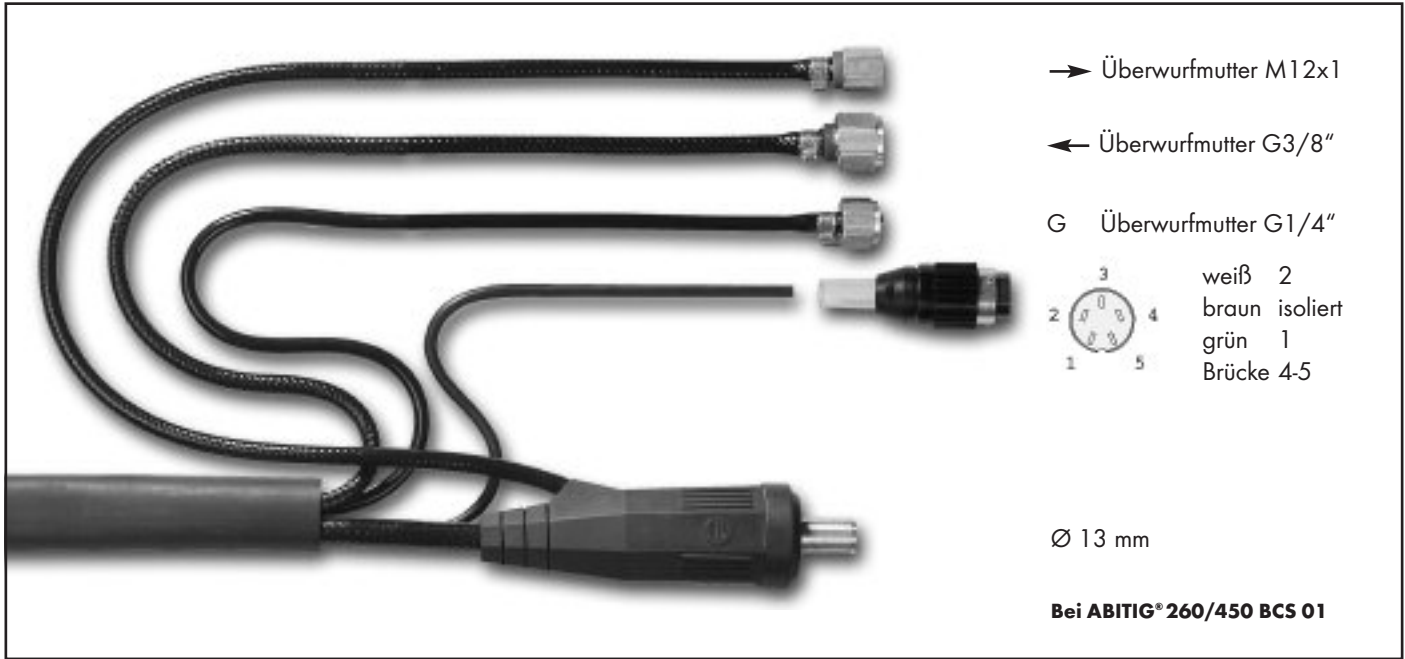

Brennertyp	Länge	Schalterfunktion	maschinenseitiger Anschluss	Schlauchpaketausführung	Bestellnummer
ABITIG® 18	4 m	ED	BSB 35-50 Tuchel 5-pol.	Standard	7S4SK043010002A30
	8 m	ED	BSB 35-50 Tuchel 5-pol.	Standard	7S4SK083010002A30
	4 m	ED	BSB 35-50 Tuchel 5-pol.	High Flex Leder	7S4SH043010002A30
	8 m	ED	BSB 35-50 Tuchel 5-pol.	High Flex Leder	7S4SH083010002A30
ABITIG® 18F	4 m	ED	BSB 35-50 Tuchel 5-pol.	Standard	7S4FK043010002A30
	8 m	ED	BSB 35-50 Tuchel 5-pol.	Standard	7S4FK083010002A30
	4 m	ED	BSB 35-50 Tuchel 5-pol.	High Flex Leder	7S4FH043010002A30
	8 m	ED	BSB 35-50 Tuchel 5-pol.	High Flex Leder	7S4FH083010002A30
ABITIG® 20	4 m	ED	BSB 35-50 Tuchel 5-pol.	Standard	7S5SK043010002A30
	8 m	ED	BSB 35-50 Tuchel 5-pol.	Standard	7S5SK083010002A30
	4 m	ED	BSB 35-50 Tuchel 5-pol.	High Flex Leder	7S5SH043010002A30
	8 m	ED	BSB 35-50 Tuchel 5-pol.	High Flex Leder	7S5SH083010002A30
ABITIG® 20F	4 m	ED	BSB 35-50 Tuchel 5-pol.	Standard	7S5FK043010002A30
	8 m	ED	BSB 35-50 Tuchel 5-pol.	Standard	7S5FK083010002A30
	4 m	ED	BSB 35-50 Tuchel 5-pol.	High Flex Leder	7S5FH043010002A30
	8 m	ED	BSB 35-50 Tuchel 5-pol.	High Flex Leder	7S5FH083010002A30

Technische Änderungen vorbehalten • Verkaufspreise = unverbindliche Preisempfehlung - Angebot freibleibend • © Copyright

ABITIG®-Brennerpreisliste

passend für WIG-Stromquellen des Fabrikates „ess“

Brennertyp	Länge	Schalterfunktion	maschinenseitiger Anschluss	Schlauchpaketausführung	Bestellnummer
ABITIG® 12-1	4 m	ED	BSB 35-50 Tuchel 5-pol.	Standard	7S6SK043010002A30
	8 m	ED	BSB 35-50 Tuchel 5-pol.	Standard	7S6SK083010002A30
	4 m	ED	BSB 35-50 Tuchel 5-pol.	High Flex Leder	7S6SH043010002A30
	8 m	ED	BSB 35-50 Tuchel 5-pol.	High Flex Leder	7S6SH083010002A30
ABITIG® 18SC	4 m	ED	BSB 35-50 Tuchel 5-pol.	Standard	7S7SK043010002A30
	8 m	ED	BSB 35-50 Tuchel 5-pol.	Standard	7S7SK083010002A30
	4 m	ED	BSB 35-50 Tuchel 5-pol.	High Flex Leder	7S7SH043010002A30
	8 m	ED	BSB 35-50 Tuchel 5-pol.	High Flex Leder	7S7SH083010002A30
ABITIG® 24W	4 m	ED	BSB 35-50 Tuchel 5-pol.	Standard	7S9SK043010002A30
	8 m	ED	BSB 35-50 Tuchel 5-pol.	Standard	7S9SK083010002A30
	4 m	ED	BSB 35-50 Tuchel 5-pol.	High Flex Leder	7S9SH043010002A30
	8 m	ED	BSB 35-50 Tuchel 5-pol.	High Flex Leder	7S9SH083010002A30
ABITIG® 450W	4 m	ED	BSB 35-50 Tuchel 5-pol.	Standard	7T5SK043010102A30
	8 m	ED	BSB 35-50 Tuchel 5-pol.	Standard	7T5SK083010102A30
	4 m	ED	BSB 35-50 Tuchel 5-pol.	High Flex Leder	7T5SH043010102A30
	8 m	ED	BSB 35-50 Tuchel 5-pol.	High Flex Leder	7T5SH083010102A30
ABITIG® 260W	4 m	ED	BSB 35-50 Tuchel 5-pol.	Standard	7T7SK043010102A30
	8 m	ED	BSB 35-50 Tuchel 5-pol.	Standard	7T7SK083010102A30
	4 m	ED	BSB 35-50 Tuchel 5-pol.	High Flex Leder	7T7SH043010102A30
	8 m	ED	BSB 35-50 Tuchel 5-pol.	High Flex Leder	7T7SH083010102A30
ABITIG® 450W SC	4 m	ED	BSB 35-50 Tuchel 5-pol.	Standard	
	8 m	ED	BSB 35-50 Tuchel 5-pol.	Standard	
	4 m	ED	BSB 35-50 Tuchel 5-pol.	High Flex Leder	7T8SH043010102A30
	8 m	ED	BSB 35-50 Tuchel 5-pol.	High Flex Leder	7T8SH083010102A30

ABITIG®-Brennerpreisliste

passend für WIG-Stromquellen des Fabrikates „ess“



Brennertyp	Länge	Schalterfunktion	maschinenseitiger Anschluss	Schlauchpaketausführung	Bestellnummer
ABITIG® 18	4 m	DD	EA Tuchel 5-pol.	Standard	7S4SK043020801B15
	8 m	DD	EA Tuchel 5-pol.	Standard	7S4SK083020801B15
	4 m	DD	EA Tuchel 5-pol.	High Flex Leder	7S4SH043020801B15
	8 m	DD	EA Tuchel 5-pol.	High Flex Leder	7S4SH083020801B15
ABITIG® 18F	4 m	DD	EA Tuchel 5-pol.	Standard	7S4FK043020801B15
	8 m	DD	EA Tuchel 5-pol.	Standard	7S4FK083020801B15
	4 m	DD	EA Tuchel 5-pol.	High Flex Leder	7S4FH043020801B15
	8 m	DD	EA Tuchel 5-pol.	High Flex Leder	7S4FH083020801B15
ABITIG® 20	4 m	DD	EA Tuchel 5-pol.	Standard	7S5SK043020801B15
	8 m	DD	EA Tuchel 5-pol.	Standard	7S5SK083020801B15
	4 m	DD	EA Tuchel 5-pol.	High Flex Leder	7S5SH043020801B15
	8 m	DD	EA Tuchel 5-pol.	High Flex Leder	7S5SH083020801B15
ABITIG® 20F	4 m	DD	EA Tuchel 5-pol.	Standard	7S5FK043020801B15
	8 m	DD	EA Tuchel 5-pol.	Standard	7S5FK083020801B15
	4 m	DD	EA Tuchel 5-pol.	High Flex Leder	7S5FH043020801B15
	8 m	DD	EA Tuchel 5-pol.	High Flex Leder	7S5FH083020801B15

Technische Änderungen vorbehalten • Verkaufspreise = unverbindliche Preisempfehlung - Angebot freibleibend • © Copyright

ABITIG®-Brennerpreisliste

passend für WIG-Stromquellen des Fabrikates „ess“

Brennertyp	Länge	Schalterfunktion	maschinenseitiger Anschluss	Schlauchpaketausführung	Bestellnummer
ABITIG® 12-1	4 m	DD	EA Tuchel 5-pol.	Standard	7S6SK043020801B15
	8 m	DD	EA Tuchel 5-pol.	Standard	7S6SK083020801B15
	4 m	DD	EA Tuchel 5-pol.	High Flex Leder	7S6SH043020801B15
	8 m	DD	EA Tuchel 5-pol.	High Flex Leder	7S6SH083020801B15
ABITIG® 18SC	4 m	DD	EA Tuchel 5-pol.	Standard	7S7SK043020801B15
	8 m	DD	EA Tuchel 5-pol.	Standard	7S7SK083020801B15
	4 m	DD	EA Tuchel 5-pol.	High Flex Leder	7S7SH043020801B15
	8 m	DD	EA Tuchel 5-pol.	High Flex Leder	7S7SH083020801B15
ABITIG® 24W	4 m	DD	EA Tuchel 5-pol.	Standard	7S9SK043020801B15
	8 m	DD	EA Tuchel 5-pol.	Standard	7S9SK083020801B15
	4 m	DD	EA Tuchel 5-pol.	High Flex Leder	7S9SH043020801B15
	8 m	DD	EA Tuchel 5-pol.	High Flex Leder	7S9SH083020801B15
ABITIG® 450W	4 m	DD	EA Tuchel 5-pol.	Standard	7T5SK043020801B15
	8 m	DD	EA Tuchel 5-pol.	Standard	7T5SK083020801B15
	4 m	DD	EA Tuchel 5-pol.	High Flex Leder	7T5SH043020801B15
	8 m	DD	EA Tuchel 5-pol.	High Flex Leder	7T5SH083020801B15
ABITIG® 260W	4 m	DD	EA Tuchel 5-pol.	Standard	7T7SK043020801B15
	8 m	DD	EA Tuchel 5-pol.	Standard	7T7SK083020801B15
	4 m	DD	EA Tuchel 5-pol.	High Flex Leder	7T7SH043020801B15
	8 m	DD	EA Tuchel 5-pol.	High Flex Leder	7T7SH083020801B15
ABITIG® 450W SC	4 m	DD	EA Tuchel 5-pol.	Standard	
	8 m	DD	EA Tuchel 5-pol.	Standard	
	4 m	DD	EA Tuchel 5-pol.	High Flex Leder	7T8SH043020801B15
	8 m	DD	EA Tuchel 5-pol.	High Flex Leder	7T8SH083020801B15

ABITIG®-Brennerpreisliste

passend für WIG-Stromquellen des Fabrikates „ess“



Brennertyp	Länge	Schalterfunktion	maschinenseitiger Anschluss	Schlauchpaketausführung	Bestellnummer
ABITIG® 18	4 m	DD	BSB 35-50 Tuchel 5-pol.	Standard	7S4SK043020001B30
	8 m	DD	BSB 35-50 Tuchel 5-pol.	Standard	7S4SK083020001B30
	4 m	DD	BSB 35-50 Tuchel 5-pol.	High Flex Leder	7S4SH043020001B30
	8 m	DD	BSB 35-50 Tuchel 5-pol.	High Flex Leder	7S4SH083020001B30
ABITIG® 18F	4 m	DD	BSB 35-50 Tuchel 5-pol.	Standard	7S4FK043020001B30
	8 m	DD	BSB 35-50 Tuchel 5-pol.	Standard	7S4FK083020001B30
	4 m	DD	BSB 35-50 Tuchel 5-pol.	High Flex Leder	7S4FH043020001B30
	8 m	DD	BSB 35-50 Tuchel 5-pol.	High Flex Leder	7S4FH083020001B30
ABITIG® 20	4 m	DD	BSB 35-50 Tuchel 5-pol.	Standard	7S5SK043020001B30
	8 m	DD	BSB 35-50 Tuchel 5-pol.	Standard	7S5SK083020001B30
	4 m	DD	BSB 35-50 Tuchel 5-pol.	High Flex Leder	7S5SH043020001B30
	8 m	DD	BSB 35-50 Tuchel 5-pol.	High Flex Leder	7S5SH083020001B30
ABITIG® 20F	4 m	DD	BSB 35-50 Tuchel 5-pol.	Standard	7S5FK043020001B30
	8 m	DD	BSB 35-50 Tuchel 5-pol.	Standard	7S5FK083020001B30
	4 m	DD	BSB 35-50 Tuchel 5-pol.	High Flex Leder	7S5FH043020001B30
	8 m	DD	BSB 35-50 Tuchel 5-pol.	High Flex Leder	7S5FH083020001B30

Technische Änderungen vorbehalten • Verkaufspreise = unverbindliche Preisempfehlung - Angebot freibleibend • © Copyright

ABITIG®-Brennerpreisliste

passend für WIG-Stromquellen des Fabrikates „ess“

Brennertyp	Länge	Schalterfunktion	maschinenseitiger Anschluss	Schlauchpaketausführung	Bestellnummer
ABITIG® 12-1	4 m	DD	BSB 35-50 Tuchel 5-pol.	Standard	7S6SK043020001B30
	8 m	DD	BSB 35-50 Tuchel 5-pol.	Standard	7S6SK083020001B30
	4 m	DD	BSB 35-50 Tuchel 5-pol.	High Flex Leder	7S6SH043020001B30
	8 m	DD	BSB 35-50 Tuchel 5-pol.	High Flex Leder	7S6SH083020001B30
ABITIG® 18SC	4 m	DD	BSB 35-50 Tuchel 5-pol.	Standard	7S7SK043020001B30
	8 m	DD	BSB 35-50 Tuchel 5-pol.	Standard	7S7SK083020001B30
	4 m	DD	BSB 35-50 Tuchel 5-pol.	High Flex Leder	7S7SH043020001B30
	8 m	DD	BSB 35-50 Tuchel 5-pol.	High Flex Leder	7S7SH083020001B30
ABITIG® 24W	4 m	DD	BSB 35-50 Tuchel 5-pol.	Standard	7S9SK043020001B30
	8 m	DD	BSB 35-50 Tuchel 5-pol.	Standard	7S9SK083020001B30
	4 m	DD	BSB 35-50 Tuchel 5-pol.	High Flex Leder	7S9SH043020001B30
	8 m	DD	BSB 35-50 Tuchel 5-pol.	High Flex Leder	7S9SH083020001B30
ABITIG® 450W	4 m	DD	BSB 35-50 Tuchel 5-pol.	Standard	7T5SK043020101B30
	8 m	DD	BSB 35-50 Tuchel 5-pol.	Standard	7T5SK083020101B30
	4 m	DD	BSB 35-50 Tuchel 5-pol.	High Flex Leder	7T5SH043020101B30
	8 m	DD	BSB 35-50 Tuchel 5-pol.	High Flex Leder	7T5SH083020101B30
ABITIG® 260W	4 m	DD	BSB 35-50 Tuchel 5-pol.	Standard	7T7SK043020101B30
	8 m	DD	BSB 35-50 Tuchel 5-pol.	Standard	7T7SK083020101B30
	4 m	DD	BSB 35-50 Tuchel 5-pol.	High Flex Leder	7T7SH043020101B30
	8 m	DD	BSB 35-50 Tuchel 5-pol.	High Flex Leder	7T7SH083020101B30
ABITIG® 450W SC	4 m	DD	BSB 35-50 Tuchel 5-pol.	Standard	
	8 m	DD	BSB 35-50 Tuchel 5-pol.	Standard	
	4 m	DD	BSB 35-50 Tuchel 5-pol.	High Flex Leder	7T8SH043020101B30
	8 m	DD	BSB 35-50 Tuchel 5-pol.	High Flex Leder	7T8SH083020101B30

ABITIG®-Brennerpreisliste

passend für WIG-Stromquellen des Fabrikates „ess“

Poti Variante nachrüstbar bei allen Stromquellen mit 17 pol. Fernregelanschluss

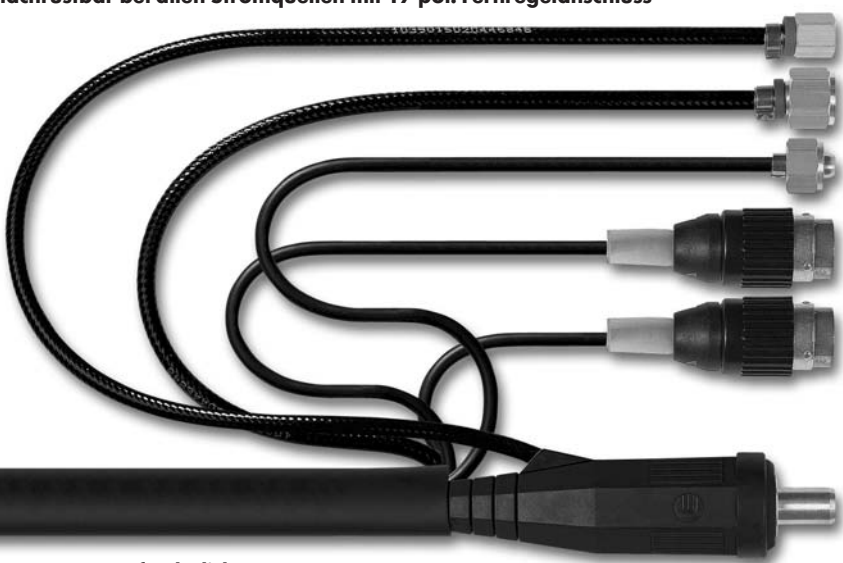

→ Überwurfmutter M12x1
 ← Überwurfmutter G3/8"
 G Überwurfmutter G1/4"

3	weiß	1
2	braun	3
4	grün	2
1	gelb	1
3	grau	2
1	rosa	3

Ø 13 mm

Bei ABITIG® 260/450 BCS 01

Filterbox Fi100 von „ess“ erforderlich

Brennertyp	Länge	Schalterfunktion	maschinenseitiger Anschluss	Schlauchpaketausführung	Bestellnummer
ABITIG® 18	4 m	DDP	BSB 35-50 Tuchel 5-pol./3-pol.	Standard	7S4SK046040052A30
	8 m	DDP	BSB 35-50 Tuchel 5-pol./3-pol.	Standard	7S4SK086040052A30
	4 m	DDP	BSB 35-50 Tuchel 5-pol./3-pol.	High Flex Leder	7S4SH046040052A30
	8 m	DDP	BSB 35-50 Tuchel 5-pol./3-pol.	High Flex Leder	7S4SH086040052A30
ABITIG® 18F	4 m	DDP	BSB 35-50 Tuchel 5-pol./3-pol.	Standard	7S4FK046040052A30
	8 m	DDP	BSB 35-50 Tuchel 5-pol./3-pol.	Standard	7S4FK086040052A30
	4 m	DDP	BSB 35-50 Tuchel 5-pol./3-pol.	High Flex Leder	7S4FH046040052A30
	8 m	DDP	BSB 35-50 Tuchel 5-pol./3-pol.	High Flex Leder	7S4FH086040052A30
ABITIG® 20	4 m	DDP	BSB 35-50 Tuchel 5-pol./3-pol.	Standard	7S5SK046040052A30
	8 m	DDP	BSB 35-50 Tuchel 5-pol./3-pol.	Standard	7S5SK086040052A30
	4 m	DDP	BSB 35-50 Tuchel 5-pol./3-pol.	High Flex Leder	7S5SH046040052A30
	8 m	DDP	BSB 35-50 Tuchel 5-pol./3-pol.	High Flex Leder	7S5SH086040052A30
ABITIG® 20F	4 m	DDP	BSB 35-50 Tuchel 5-pol./3-pol.	Standard	7S5FK046040052A30
	8 m	DDP	BSB 35-50 Tuchel 5-pol./3-pol.	Standard	7S5FK086040052A30
	4 m	DDP	BSB 35-50 Tuchel 5-pol./3-pol.	High Flex Leder	7S5FH046040052A30
	8 m	DDP	BSB 35-50 Tuchel 5-pol./3-pol.	High Flex Leder	7S5FH086040052A30

Technische Änderungen vorbehalten • Verkaufspreise = unverbindliche Preisempfehlung - Angebot freibleibend • © Copyright

ABITIG®-Brennerpreisliste

passend für WIG-Stromquellen des Fabrikates „ess“

Brennertyp	Länge	Schalterfunktion	maschinenseitiger Anschluss	Schlauchpaketausführung	Bestellnummer
ABITIG® 12-1	4 m	DDP	BSB 35-50 Tuchel 5-pol./3-pol.	Standard	7S6SK046040052A30
	8 m	DDP	BSB 35-50 Tuchel 5-pol./3-pol.	Standard	7S6SK086040052A30
	4 m	DDP	BSB 35-50 Tuchel 5-pol./3-pol.	High Flex Leder	7S6SH046040052A30
	8 m	DDP	BSB 35-50 Tuchel 5-pol./3-pol.	High Flex Leder	7S6SH086040052A30

ABITIG® 18SC	4 m	DDP	BSB 35-50 Tuchel 5-pol./3-pol.	Standard	7S7SK046040052A30
	8 m	DDP	BSB 35-50 Tuchel 5-pol./3-pol.	Standard	7S7SK086040052A30
	4 m	DDP	BSB 35-50 Tuchel 5-pol./3-pol.	High Flex Leder	7S7SH046040052A30
	8 m	DDP	BSB 35-50 Tuchel 5-pol./3-pol.	High Flex Leder	7S7SH086040052A30

ABITIG® 24W	4 m	DDP	BSB 35-50 Tuchel 5-pol./3-pol.	Standard	7S9SK046040052A30
	8 m	DDP	BSB 35-50 Tuchel 5-pol./3-pol.	Standard	7S9SK086040052A30
	4 m	DDP	BSB 35-50 Tuchel 5-pol./3-pol.	High Flex Leder	7S9SH046040052A30
	8 m	DDP	BSB 35-50 Tuchel 5-pol./3-pol.	High Flex Leder	7S9SH086040052A30

ABITIG® 450W	4 m	DDP	BSB 35-50 Tuchel 5-pol./3-pol.	Standard	7T5SK046040152A30
	8 m	DDP	BSB 35-50 Tuchel 5-pol./3-pol.	Standard	7T5SK086040152A30
	4 m	DDP	BSB 35-50 Tuchel 5-pol./3-pol.	High Flex Leder	7T5SH046040152A30
	8 m	DDP	BSB 35-50 Tuchel 5-pol./3-pol.	High Flex Leder	7T5SH086040152A30

ABITIG® 260W	4 m	DDP	BSB 35-50 Tuchel 5-pol./3-pol.	Standard	7T7SK046040152A30
	8 m	DDP	BSB 35-50 Tuchel 5-pol./3-pol.	Standard	7T7SK086040152A30
	4 m	DDP	BSB 35-50 Tuchel 5-pol./3-pol.	High Flex Leder	7T7SH046040152A30
	8 m	DDP	BSB 35-50 Tuchel 5-pol./3-pol.	High Flex Leder	7T7SH086040152A30

ABITIG® 450W SC	4 m	DDP	BSB 35-50 Tuchel 5-pol./3-pol.	Standard	
	8 m	DDP	BSB 35-50 Tuchel 5-pol./3-pol.	Standard	
	4 m	DDP	BSB 35-50 Tuchel 5-pol./3-pol.	High Flex Leder	7T8SH046040152A30
	8 m	DDP	BSB 35-50 Tuchel 5-pol./3-pol.	High Flex Leder	7T8SH086040152A30

ABITIG®-Brennerpreisliste

passend für WIG-Stromquellen des Fabrikates „ess“



Brennertyp	Länge	Schalterfunktion	maschinenseitiger Anschluss	Schlauchpaketausführung	Bestellnummer
ABITIG® 18	4 m	DD	BSB 35-50 Tuchel 5-pol.	Standard	7S4SK043020001B16
	8 m	DD	BSB 35-50 Tuchel 5-pol.	Standard	7S4SK083020001B16
	4 m	DD	BSB 35-50 Tuchel 5-pol.	High Flex Leder	7S4SH043020001B16
	8 m	DD	BSB 35-50 Tuchel 5-pol.	High Flex Leder	7S4SH083020001B16
ABITIG® 18F	4 m	DD	BSB 35-50 Tuchel 5-pol.	Standard	7S4FK043020001B16
	8 m	DD	BSB 35-50 Tuchel 5-pol.	Standard	7S4FK083020001B16
	4 m	DD	BSB 35-50 Tuchel 5-pol.	High Flex Leder	7S4FH043020001B16
	8 m	DD	BSB 35-50 Tuchel 5-pol.	High Flex Leder	7S4FH083020001B16
ABITIG® 20	4 m	DD	BSB 35-50 Tuchel 5-pol.	Standard	7S5SK043020001B16
	8 m	DD	BSB 35-50 Tuchel 5-pol.	Standard	7S5SK083020001B16
	4 m	DD	BSB 35-50 Tuchel 5-pol.	High Flex Leder	7S5SH043020001B16
	8 m	DD	BSB 35-50 Tuchel 5-pol.	High Flex Leder	7S5SH083020001B16
ABITIG® 20F	4 m	DD	BSB 35-50 Tuchel 5-pol.	Standard	7S5FK043020001B16
	8 m	DD	BSB 35-50 Tuchel 5-pol.	Standard	7S5FK083020001B16
	4 m	DD	BSB 35-50 Tuchel 5-pol.	High Flex Leder	7S5FH043020001B16
	8 m	DD	BSB 35-50 Tuchel 5-pol.	High Flex Leder	7S5FH083020001B16

Technische Änderungen vorbehalten • Verkaufspreise = unverbindliche Preisempfehlung - Angebot freibleibend • © Copyright

ABITIG®-Brennerpreisliste

passend für WIG-Stromquellen des Fabrikates „ess“

Brennertyp	Länge	Schalterfunktion	maschinenseitiger Anschluss	Schlauchpaketausführung	Bestellnummer
ABITIG® 12-1	4 m	DD	BSB 35-50 Tuchel 5-pol.	Standard	7S6SK043020001B16
	8 m	DD	BSB 35-50 Tuchel 5-pol.	Standard	7S6SK083020001B16
	4 m	DD	BSB 35-50 Tuchel 5-pol.	High Flex Leder	7S6SH043020001B16
	8 m	DD	BSB 35-50 Tuchel 5-pol.	High Flex Leder	7S6SH083020001B16
ABITIG® 18SC	4 m	DD	BSB 35-50 Tuchel 5-pol.	Standard	7S7SK043020001B16
	8 m	DD	BSB 35-50 Tuchel 5-pol.	Standard	7S7SK083020001B16
	4 m	DD	BSB 35-50 Tuchel 5-pol.	High Flex Leder	7S7SH043020001B16
	8 m	DD	BSB 35-50 Tuchel 5-pol.	High Flex Leder	7S7SH083020001B16
ABITIG® 24W	4 m	DD	BSB 35-50 Tuchel 5-pol.	Standard	7S9SK043020001B16
	8 m	DD	BSB 35-50 Tuchel 5-pol.	Standard	7S9SK083020001B16
	4 m	DD	BSB 35-50 Tuchel 5-pol.	High Flex Leder	7S9SH043020001B16
	8 m	DD	BSB 35-50 Tuchel 5-pol.	High Flex Leder	7S9SH083020001B16
ABITIG® 450W	4 m	DD	BSB 35-50 Tuchel 5-pol.	Standard	7T5SK043020101B16
	8 m	DD	BSB 35-50 Tuchel 5-pol.	Standard	7T5SK083020101B16
	4 m	DD	BSB 35-50 Tuchel 5-pol.	High Flex Leder	7T5SH043020101B16
	8 m	DD	BSB 35-50 Tuchel 5-pol.	High Flex Leder	7T5SH083020101B16
ABITIG® 260W	4 m	DD	BSB 35-50 Tuchel 5-pol.	Standard	7T7SK043020101B16
	8 m	DD	BSB 35-50 Tuchel 5-pol.	Standard	7T7SK083020101B16
	4 m	DD	BSB 35-50 Tuchel 5-pol.	High Flex Leder	7T7SH043020101B16
	8 m	DD	BSB 35-50 Tuchel 5-pol.	High Flex Leder	7T7SH083020101B16
ABITIG® 450W SC	4 m	DD	BSB 35-50 Tuchel 5-pol.	Standard	
	8 m	DD	BSB 35-50 Tuchel 5-pol.	Standard	
	4 m	DD	BSB 35-50 Tuchel 5-pol.	High Flex Leder	7T8SH043020101B16
	8 m	DD	BSB 35-50 Tuchel 5-pol.	High Flex Leder	7T8SH083020101B16

ABITIG®-Brennerpreisliste

passend für WIG-Stromquellen des Fabrikates „eseti“

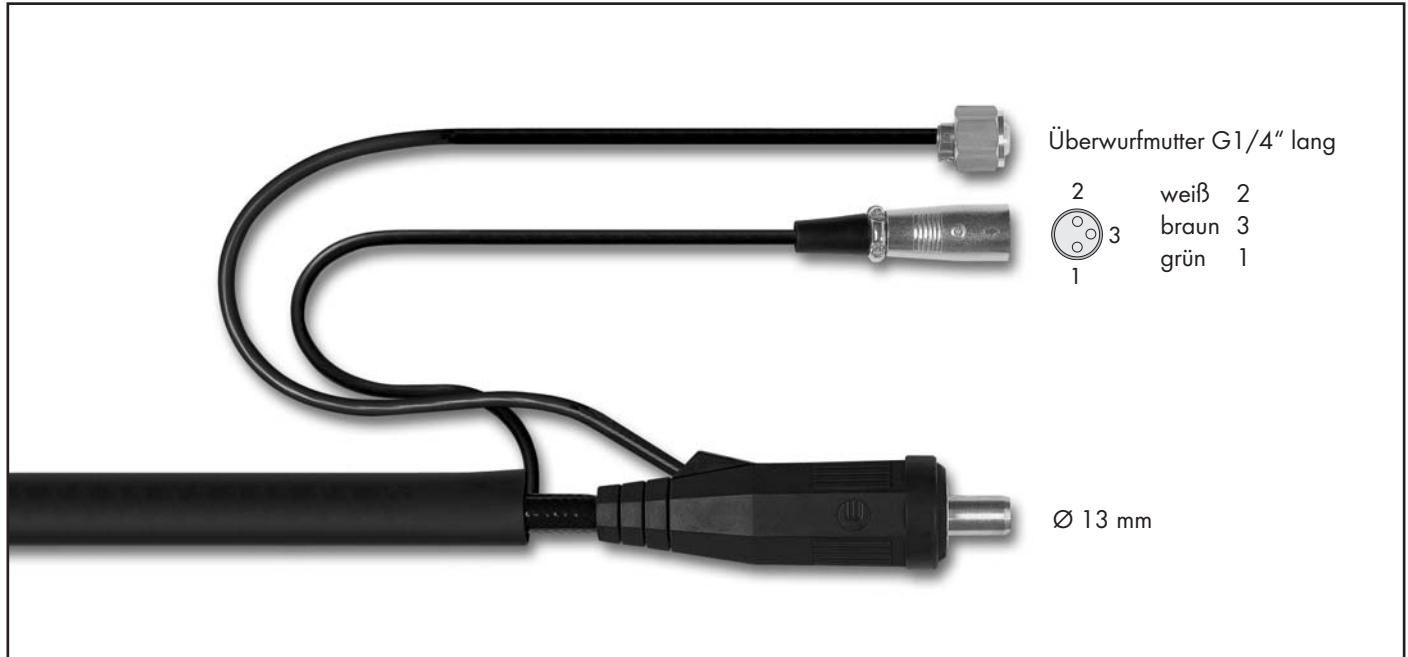

Brennertyp	Länge	Schalterfunktion	maschinenseitiger Anschluss	Schlauchpaketausführung	Bestellnummer
ABITIG® 9	4 m	DD	BSB 35-50 Rundsteckverb. 3-pol.	Standard	7S1SK043020041A51
	8 m	DD	BSB 35-50 Rundsteckverb. 3-pol.	Standard	7S1SK083020041A51
	4 m	DD	BSB 35-50 Rundsteckverb. 3-pol.	High Flex Leder	7S1SH043020041A51
	8 m	DD	BSB 35-50 Rundsteckverb. 3-pol.	High Flex Leder	7S1SH083020041A51

ABITIG® 9F	4 m	DD	BSB 35-50 Rundsteckverb. 3-pol.	Standard	7S1FK043020041A51
	8 m	DD	BSB 35-50 Rundsteckverb. 3-pol.	Standard	7S1FK083020041A51
	4 m	DD	BSB 35-50 Rundsteckverb. 3-pol.	High Flex Leder	7S1FH043020041A51
	8 m	DD	BSB 35-50 Rundsteckverb. 3-pol.	High Flex Leder	7S1FH083020041A51

ABITIG® 17	4 m	DD	BSB 35-50 Rundsteckverb. 3-pol.	Standard	7S2SK043020041A51
	8 m	DD	BSB 35-50 Rundsteckverb. 3-pol.	Standard	7S2SK083020041A51
	4 m	DD	BSB 35-50 Rundsteckverb. 3-pol.	High Flex Leder	7S2SH043020041A51
	8 m	DD	BSB 35-50 Rundsteckverb. 3-pol.	High Flex Leder	7S2SH083020041A51

ABITIG® 17F	4 m	DD	BSB 35-50 Rundsteckverb. 3-pol.	Standard	7S2FK043020041A51
	8 m	DD	BSB 35-50 Rundsteckverb. 3-pol.	Standard	7S2FK083020041A51
	4 m	DD	BSB 35-50 Rundsteckverb. 3-pol.	High Flex Leder	7S2FH043020041A51
	8 m	DD	BSB 35-50 Rundsteckverb. 3-pol.	High Flex Leder	7S2FH083020041A51

Technische Änderungen vorbehalten • Verkaufspreise = unverbindliche Preisempfehlung - Angebot freibleibend • © Copyright

ABITIG®-Brennerpreisliste

passend für WIG-Stromquellen des Fabrikates „esseti“

Brennertyp	Länge	Schalterfunktion	maschinenseitiger Anschluss	Schlauchpaketausführung	Bestellnummer
ABITIG® 26	4 m	DD	BSB 35-50 Rundsteckverb. 3-pol.	Standard	7S3SK043020041A51
	8 m	DD	BSB 35-50 Rundsteckverb. 3-pol.	Standard	7S3SK083020041A51
	4 m	DD	BSB 35-50 Rundsteckverb. 3-pol.	High Flex Leder	7S3SH043020041A51
	8 m	DD	BSB 35-50 Rundsteckverb. 3-pol.	High Flex Leder	7S3SH083020041A51

ABITIG® 26F	4 m	DD	BSB 35-50 Rundsteckverb. 3-pol.	Standard	7S3FK043020041A51
	8 m	DD	BSB 35-50 Rundsteckverb. 3-pol.	Standard	7S3FK083020041A51
	4 m	DD	BSB 35-50 Rundsteckverb. 3-pol.	High Flex Leder	7S3FH043020041A51
	8 m	DD	BSB 35-50 Rundsteckverb. 3-pol.	High Flex Leder	7S3FH083020041A51

ABITIG® 24G	4 m	DD	BSB 35-50 Rundsteckverb. 3-pol.	Standard	7S8SK043020041A51
	8 m	DD	BSB 35-50 Rundsteckverb. 3-pol.	Standard	7S8SK083020041A51
	4 m	DD	BSB 35-50 Rundsteckverb. 3-pol.	High Flex Leder	7S8SH043020041A51
	8 m	DD	BSB 35-50 Rundsteckverb. 3-pol.	High Flex Leder	7S8SH083020041A51

ABITIG® 200	4 m	DD	BSB 35-50 Rundsteckverb. 3-pol.	Standard	7T4SK043020041A51
	8 m	DD	BSB 35-50 Rundsteckverb. 3-pol.	Standard	7T4SK083020041A51
	4 m	DD	BSB 35-50 Rundsteckverb. 3-pol.	High Flex Leder	7T4SH043020041A51
	8 m	DD	BSB 35-50 Rundsteckverb. 3-pol.	High Flex Leder	7T4SH083020041A51

ABITIG® 150	4 m	DD	BSB 35-50 Rundsteckverb. 3-pol.	Standard	7T6SK043020041A51
	8 m	DD	BSB 35-50 Rundsteckverb. 3-pol.	Standard	7T6SK083020041A51
	4 m	DD	BSB 35-50 Rundsteckverb. 3-pol.	High Flex Leder	7T6SH043020041A51
	8 m	DD	BSB 35-50 Rundsteckverb. 3-pol.	High Flex Leder	7T6SH083020041A51

ABITIG®-Brennerpreisliste

passend für WIG-Stromquellen des Fabrikates „eseti“

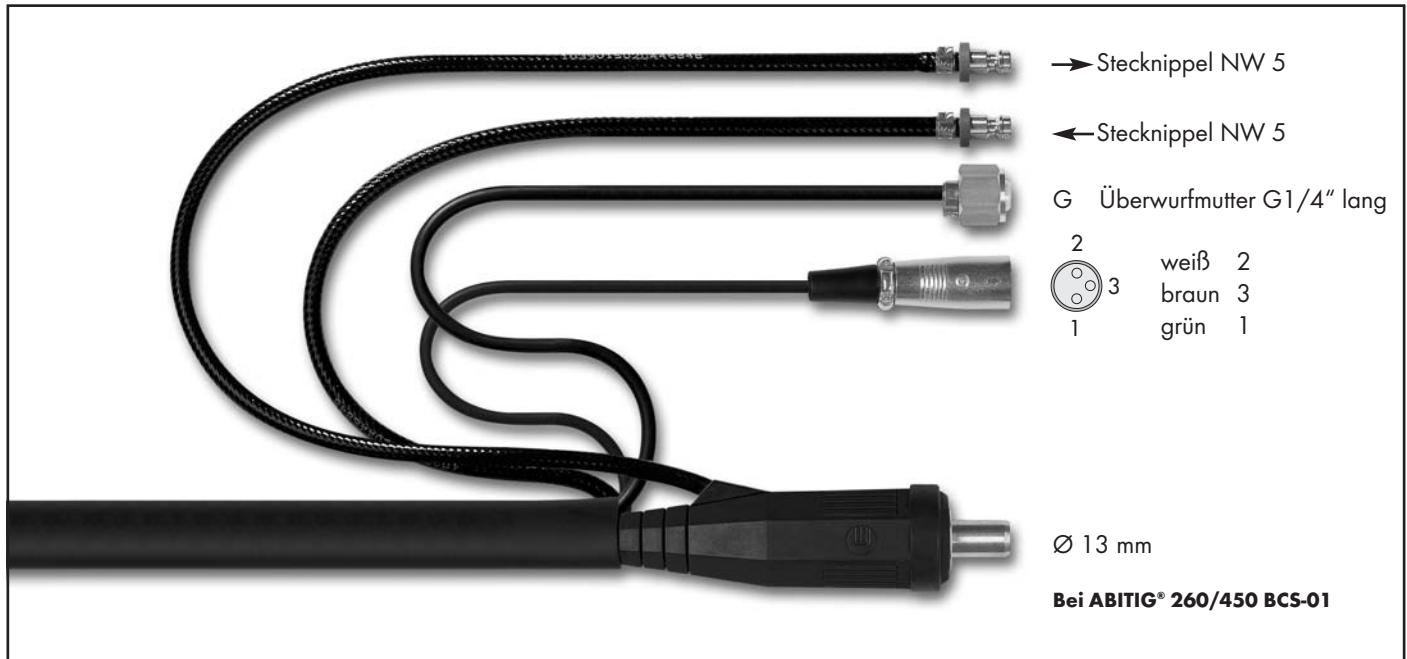

Brennertyp	Länge	Schalterfunktion	maschinenseitiger Anschluss	Schlauchpaketausführung	Bestellnummer
ABITIG® 18	4 m	DD	BSB 35-50 Rundsteckverb. 3-pol.	Standard	7S4SK043020041A81
	8 m	DD	BSB 35-50 Rundsteckverb. 3-pol.	Standard	7S4SK083020041A81
	4 m	DD	BSB 35-50 Rundsteckverb. 3-pol.	High Flex Leder	7S4SH043020041A81
	8 m	DD	BSB 35-50 Rundsteckverb. 3-pol.	High Flex Leder	7S4SH083020041A81
ABITIG® 18F	4 m	DD	BSB 35-50 Rundsteckverb. 3-pol.	Standard	7S4FK043020041A81
	8 m	DD	BSB 35-50 Rundsteckverb. 3-pol.	Standard	7S4FK083020041A81
	4 m	DD	BSB 35-50 Rundsteckverb. 3-pol.	High Flex Leder	7S4FH043020041A81
	8 m	DD	BSB 35-50 Rundsteckverb. 3-pol.	High Flex Leder	7S4FH083020041A81
ABITIG® 20	4 m	DD	BSB 35-50 Rundsteckverb. 3-pol.	Standard	7S5SK043020041A81
	8 m	DD	BSB 35-50 Rundsteckverb. 3-pol.	Standard	7S5SK083020041A81
	4 m	DD	BSB 35-50 Rundsteckverb. 3-pol.	High Flex Leder	7S5SH043020041A81
	8 m	DD	BSB 35-50 Rundsteckverb. 3-pol.	High Flex Leder	7S5SH083020041A81
ABITIG® 20F	4 m	DD	BSB 35-50 Rundsteckverb. 3-pol.	Standard	7S5FK043020041A81
	8 m	DD	BSB 35-50 Rundsteckverb. 3-pol.	Standard	7S5FK083020041A81
	4 m	DD	BSB 35-50 Rundsteckverb. 3-pol.	High Flex Leder	7S5FH043020041A81
	8 m	DD	BSB 35-50 Rundsteckverb. 3-pol.	High Flex Leder	7S5FH083020041A81

Technische Änderungen vorbehalten • Verkaufspreise = unverbindliche Preisempfehlung - Angebot freibleibend • © Copyright

ABITIG®-Brennerpreisliste

passend für WIG-Stromquellen des Fabrikates „esseti“

Brennertyp	Länge	Schalterfunktion	maschinenseitiger Anschluss	Schlauchpaketausführung	Bestellnummer
ABITIG® 12-1	4 m	DD	BSB 35-50 Rundsteckverb. 3-pol.	Standard	7S6SK043020041A81
	8 m	DD	BSB 35-50 Rundsteckverb. 3-pol.	Standard	7S6SK083020041A81
	4 m	DD	BSB 35-50 Rundsteckverb. 3-pol.	High Flex Leder	7S6SH043020041A81
	8 m	DD	BSB 35-50 Rundsteckverb. 3-pol.	High Flex Leder	7S6SH083020041A81
ABITIG® 18SC	4 m	DD	BSB 35-50 Rundsteckverb. 3-pol.	Standard	7S7SK043020041A81
	8 m	DD	BSB 35-50 Rundsteckverb. 3-pol.	Standard	7S7SK083020041A81
	4 m	DD	BSB 35-50 Rundsteckverb. 3-pol.	High Flex Leder	7S7SH043020041A81
	8 m	DD	BSB 35-50 Rundsteckverb. 3-pol.	High Flex Leder	7S7SH083020041A81
ABITIG® 24W	4 m	DD	BSB 35-50 Rundsteckverb. 3-pol.	Standard	7S9SK043020041A81
	8 m	DD	BSB 35-50 Rundsteckverb. 3-pol.	Standard	7S9SK083020041A81
	4 m	DD	BSB 35-50 Rundsteckverb. 3-pol.	High Flex Leder	7S9SH043020041A81
	8 m	DD	BSB 35-50 Rundsteckverb. 3-pol.	High Flex Leder	7S9SH083020041A81
ABITIG® 450W	4 m	DD	BSB 35-50 Rundsteckverb. 3-pol.	Standard	7T5SK043020141A81
	8 m	DD	BSB 35-50 Rundsteckverb. 3-pol.	Standard	7T5SK083020141A81
	4 m	DD	BSB 35-50 Rundsteckverb. 3-pol.	High Flex Leder	7T5SH043020141A81
	8 m	DD	BSB 35-50 Rundsteckverb. 3-pol.	High Flex Leder	7T5SH083020141A81
ABITIG® 260W	4 m	DD	BSB 35-50 Rundsteckverb. 3-pol.	Standard	7T7SK043020141A81
	8 m	DD	BSB 35-50 Rundsteckverb. 3-pol.	Standard	7T7SK083020141A81
	4 m	DD	BSB 35-50 Rundsteckverb. 3-pol.	High Flex Leder	7T7SH043020141A81
	8 m	DD	BSB 35-50 Rundsteckverb. 3-pol.	High Flex Leder	7T7SH083020141A81
ABITIG® 450W SC	4 m	DD	BSB 35-50 Rundsteckverb. 3-pol.	Standard	
	8 m	DD	BSB 35-50 Rundsteckverb. 3-pol.	Standard	
	4 m	DD	BSB 35-50 Rundsteckverb. 3-pol.	High Flex Leder	7T8SH043020141A81
	8 m	DD	BSB 35-50 Rundsteckverb. 3-pol.	High Flex Leder	7T8SH083020141A81

ABITIG®-Brennerpreisliste

passend für WIG-Stromquellen des Fabrikates „ewm“



Brennertyp	Länge	Schalterfunktion	maschinenseitiger Anschluss	Schlauchpaketausführung	Bestellnummer
ABITIG® 9	4 m	DD	BSB 35-50 Tuchel 5-pol.	Standard	7S1SK043020001A01
	8 m	DD	BSB 35-50 Tuchel 5-pol.	Standard	7S1SK083020001A01
	4 m	DD	BSB 35-50 Tuchel 5-pol.	High Flex Leder	7S1SH043020001A01
	8 m	DD	BSB 35-50 Tuchel 5-pol.	High Flex Leder	7S1SH083020001A01

ABITIG® 9F	4 m	DD	BSB 35-50 Tuchel 5-pol.	Standard	7S1FK043020001A01
	8 m	DD	BSB 35-50 Tuchel 5-pol.	Standard	7S1FK083020001A01
	4 m	DD	BSB 35-50 Tuchel 5-pol.	High Flex Leder	7S1FH043020001A01
	8 m	DD	BSB 35-50 Tuchel 5-pol.	High Flex Leder	7S1FH083020001A01

ABITIG® 17	4 m	DD	BSB 35-50 Tuchel 5-pol.	Standard	7S2SK043020001A01
	8 m	DD	BSB 35-50 Tuchel 5-pol.	Standard	7S2SK083020001A01
	4 m	DD	BSB 35-50 Tuchel 5-pol.	High Flex Leder	7S2SH043020001A01
	8 m	DD	BSB 35-50 Tuchel 5-pol.	High Flex Leder	7S2SH083020001A01

ABITIG® 17F	4 m	DD	BSB 35-50 Tuchel 5-pol.	Standard	7S2FK043020001A01
	8 m	DD	BSB 35-50 Tuchel 5-pol.	Standard	7S2FK083020001A01
	4 m	DD	BSB 35-50 Tuchel 5-pol.	High Flex Leder	7S2FH043020001A01
	8 m	DD	BSB 35-50 Tuchel 5-pol.	High Flex Leder	7S2FH083020001A01

Technische Änderungen vorbehalten • Verkaufspreise = unverbindliche Preisempfehlung - Angebot freibleibend • © Copyright

ABITIG®-Brennerpreisliste

passend für WIG-Stromquellen des Fabrikates „ewm“

Brennertyp	Länge	Schalterfunktion	maschinenseitiger Anschluss	Schlauchpaketausführung	Bestellnummer
ABITIG® 26	4 m	DD	BSB 35-50 Tuchel 5-pol.	Standard	7S3SK043020001A01
	8 m	DD	BSB 35-50 Tuchel 5-pol.	Standard	7S3SK083020001A01
	4 m	DD	BSB 35-50 Tuchel 5-pol.	High Flex Leder	7S3SH043020001A01
	8 m	DD	BSB 35-50 Tuchel 5-pol.	High Flex Leder	7S3SH083020001A01
ABITIG® 26F	4 m	DD	BSB 35-50 Tuchel 5-pol.	Standard	7S3FK043020001A01
	8 m	DD	BSB 35-50 Tuchel 5-pol.	Standard	7S3FK083020001A01
	4 m	DD	BSB 35-50 Tuchel 5-pol.	High Flex Leder	7S3FH043020001A01
	8 m	DD	BSB 35-50 Tuchel 5-pol.	High Flex Leder	7S3FH083020001A01
ABITIG® 24G	4 m	DD	BSB 35-50 Tuchel 5-pol.	Standard	7S8SK043020001A01
	8 m	DD	BSB 35-50 Tuchel 5-pol.	Standard	7S8SK083020001A01
	4 m	DD	BSB 35-50 Tuchel 5-pol.	High Flex Leder	7S8SH043020001A01
	8 m	DD	BSB 35-50 Tuchel 5-pol.	High Flex Leder	7S8SH083020001A01
ABITIG® 200	4 m	DD	BSB 35-50 Tuchel 5-pol.	Standard	7T4SK043020001A01
	8 m	DD	BSB 35-50 Tuchel 5-pol.	Standard	7T4SK083020001A01
	4 m	DD	BSB 35-50 Tuchel 5-pol.	High Flex Leder	7T4SH043020001A01
	8 m	DD	BSB 35-50 Tuchel 5-pol.	High Flex Leder	7T4SH083020001A01
ABITIG® 200F	4 m	DD	BSB 35-50 Tuchel 5-pol.	Standard	7T4FK043020001A01
	8 m	DD	BSB 35-50 Tuchel 5-pol.	Standard	7T4FK083020001A01
	4 m	DD	BSB 35-50 Tuchel 5-pol.	High Flex Leder	7T4FH043020001A01
	8 m	DD	BSB 35-50 Tuchel 5-pol.	High Flex Leder	7T4FH083020001A01
ABITIG® 150	4 m	DD	BSB 35-50 Tuchel 5-pol.	Standard	7T6SK043020001A01
	8 m	DD	BSB 35-50 Tuchel 5-pol.	Standard	7T6SK083020001A01
	4 m	DD	BSB 35-50 Tuchel 5-pol.	High Flex Leder	7T6SH043020001A01
	8 m	DD	BSB 35-50 Tuchel 5-pol.	High Flex Leder	7T6SH083020001A01
ABITIG® 150F	4 m	DD	BSB 35-50 Tuchel 5-pol.	Standard	7T6FK043020001A01
	8 m	DD	BSB 35-50 Tuchel 5-pol.	Standard	7T6FK083020001A01
	4 m	DD	BSB 35-50 Tuchel 5-pol.	High Flex Leder	7T6FH043020001A01
	8 m	DD	BSB 35-50 Tuchel 5-pol.	High Flex Leder	7T6FH083020001A01

ABITIG®-Brennerpreisliste

passend für WIG-Stromquellen des Fabrikates „ewm“



Brennertyp	Länge	Schalterfunktion	maschinenseitiger Anschluss	Schlauchpaketausführung	Bestellnummer
ABITIG® 9	4 m	DD	ZA - GZ Tuchel 5-pol.	Standard	7S1SK043020301A00
	8 m	DD	ZA - GZ Tuchel 5-pol.	Standard	7S1SK083020301A00
	4 m	DD	ZA - GZ Tuchel 5-pol.	High Flex Leder	7S1SH043020301A00
	8 m	DD	ZA - GZ Tuchel 5-pol.	High Flex Leder	7S1SH083020301A00
ABITIG® 9F	4 m	DD	ZA - GZ Tuchel 5-pol.	Standard	7S1FK043020301A00
	8 m	DD	ZA - GZ Tuchel 5-pol.	Standard	7S1FK083020301A00
	4 m	DD	ZA - GZ Tuchel 5-pol.	High Flex Leder	7S1FH043020301A00
	8 m	DD	ZA - GZ Tuchel 5-pol.	High Flex Leder	7S1FH083020301A00
ABITIG® 17	4 m	DD	ZA - GZ Tuchel 5-pol.	Standard	7S2SK043020301A00
	8 m	DD	ZA - GZ Tuchel 5-pol.	Standard	7S2SK083020301A00
	4 m	DD	ZA - GZ Tuchel 5-pol.	High Flex Leder	7S2SH043020301A00
	8 m	DD	ZA - GZ Tuchel 5-pol.	High Flex Leder	7S2SH083020301A00
ABITIG® 17F	4 m	DD	ZA - GZ Tuchel 5-pol.	Standard	7S2FK043020301A00
	8 m	DD	ZA - GZ Tuchel 5-pol.	Standard	7S2FK083020301A00
	4 m	DD	ZA - GZ Tuchel 5-pol.	High Flex Leder	7S2FH043020301A00
	8 m	DD	ZA - GZ Tuchel 5-pol.	High Flex Leder	7S2FH083020301A00

Technische Änderungen vorbehalten • Verkaufspreise = unverbindliche Preisempfehlung - Angebot freibleibend • © Copyright

ABITIG®-Brennerpreisliste

passend für WIG-Stromquellen des Fabrikates „ewm“

Brennertyp	Länge	Schalterfunktion	maschinenseitiger Anschluss	Schlauchpaketausführung	Bestellnummer
ABITIG® 26	4 m	DD	ZA - GZ Tuchel 5-pol.	Standard	7S3SK043020301A00
	8 m	DD	ZA - GZ Tuchel 5-pol.	Standard	7S3SK083020301A00
	4 m	DD	ZA - GZ Tuchel 5-pol.	High Flex Leder	7S3SH043020301A00
	8 m	DD	ZA - GZ Tuchel 5-pol.	High Flex Leder	7S3SH083020301A00
ABITIG® 26F	4 m	DD	ZA - GZ Tuchel 5-pol.	Standard	7S3FK043020301A00
	8 m	DD	ZA - GZ Tuchel 5-pol.	Standard	7S3FK083020301A00
	4 m	DD	ZA - GZ Tuchel 5-pol.	High Flex Leder	7S3FH043020301A00
	8 m	DD	ZA - GZ Tuchel 5-pol.	High Flex Leder	7S3FH083020301A00
ABITIG® 24G	4 m	DD	ZA - GZ Tuchel 5-pol.	Standard	7S8SK043020301A00
	8 m	DD	ZA - GZ Tuchel 5-pol.	Standard	7S8SK083020301A00
	4 m	DD	ZA - GZ Tuchel 5-pol.	High Flex Leder	7S8SH043020301A00
	8 m	DD	ZA - GZ Tuchel 5-pol.	High Flex Leder	7S8SH083020301A00
ABITIG® 200	4 m	DD	ZA - GZ Tuchel 5-pol.	Standard	7T4SK043020301A00
	8 m	DD	ZA - GZ Tuchel 5-pol.	Standard	7T4SK083020301A00
	4 m	DD	ZA - GZ Tuchel 5-pol.	High Flex Leder	7T4SH043020301A00
	8 m	DD	ZA - GZ Tuchel 5-pol.	High Flex Leder	7T4SH083020301A00
ABITIG® 200F	4 m	DD	ZA - GZ Tuchel 5-pol.	Standard	7T4FK043020301A00
	8 m	DD	ZA - GZ Tuchel 5-pol.	Standard	7T4FK083020301A00
	4 m	DD	ZA - GZ Tuchel 5-pol.	High Flex Leder	7T4FH043020301A00
	8 m	DD	ZA - GZ Tuchel 5-pol.	High Flex Leder	7T4FH083020301A00
ABITIG® 150	4 m	DD	ZA - GZ Tuchel 5-pol.	Standard	7T6SK043020301A00
	8 m	DD	ZA - GZ Tuchel 5-pol.	Standard	7T6SK083020301A00
	4 m	DD	ZA - GZ Tuchel 5-pol.	High Flex Leder	7T6SH043020301A00
	8 m	DD	ZA - GZ Tuchel 5-pol.	High Flex Leder	7T6SH083020301A00
ABITIG® 150F	4 m	DD	ZA - GZ Tuchel 5-pol.	Standard	7T6FK043020301A00
	8 m	DD	ZA - GZ Tuchel 5-pol.	Standard	7T6FK083020301A00
	4 m	DD	ZA - GZ Tuchel 5-pol.	High Flex Leder	7T6FH043020301A00
	8 m	DD	ZA - GZ Tuchel 5-pol.	High Flex Leder	7T6FH083020301A00

ABITIG®-Brennerpreisliste

passend für WIG-Stromquellen des Fabrikates „ewm“



Brennertyp	Länge	Schalterfunktion	maschinenseitiger Anschluss	Schlauchpaketausführung	Bestellnummer
ABITIG® 9	4 m	DDP	BSB 35-50 Burndy 8-pol.	Standard	7S1SK046040028A01
	8 m	DDP	BSB 35-50 Burndy 8-pol.	Standard	7S1SK086040028A01
	4 m	DDP	BSB 35-50 Burndy 8-pol.	High Flex Leder	7S1SH046040028A01
	8 m	DDP	BSB 35-50 Burndy 8-pol.	High Flex Leder	7S1SH086040028A01

ABITIG® 9F	4 m	DDP	BSB 35-50 Burndy 8-pol.	Standard	7S1FK046040028A01
	8 m	DDP	BSB 35-50 Burndy 8-pol.	Standard	7S1FK086040028A01
	4 m	DDP	BSB 35-50 Burndy 8-pol.	High Flex Leder	7S1FH046040028A01
	8 m	DDP	BSB 35-50 Burndy 8-pol.	High Flex Leder	7S1FH086040028A01

ABITIG® 17	4 m	DDP	BSB 35-50 Burndy 8-pol.	Standard	7S2SK046040028A01
	8 m	DDP	BSB 35-50 Burndy 8-pol.	Standard	7S2SK086040028A01
	4 m	DDP	BSB 35-50 Burndy 8-pol.	High Flex Leder	7S2SH046040028A01
	8 m	DDP	BSB 35-50 Burndy 8-pol.	High Flex Leder	7S2SH086040028A01

ABITIG® 17F	4 m	DDP	BSB 35-50 Burndy 8-pol.	Standard	7S2FK046040028A01
	8 m	DDP	BSB 35-50 Burndy 8-pol.	Standard	7S2FK086040028A01
	4 m	DDP	BSB 35-50 Burndy 8-pol.	High Flex Leder	7S2FH046040028A01
	8 m	DDP	BSB 35-50 Burndy 8-pol.	High Flex Leder	7S2FH086040028A01

Technische Änderungen vorbehalten • Verkaufspreise = unverbindliche Preisempfehlung - Angebot freibleibend • © Copyright

ABITIG®-Brennerpreisliste

passend für WIG-Stromquellen des Fabrikates „ewm“

Brennertyp	Länge	Schalterfunktion	maschinenseitiger Anschluss	Schlauchpaketausführung	Bestellnummer
ABITIG® 26	4 m	DDP	BSB 35-50 Burndy 8-pol.	Standard	7S3SK046040028A01
	8 m	DDP	BSB 35-50 Burndy 8-pol.	Standard	7S3SK086040028A01
	4 m	DDP	BSB 35-50 Burndy 8-pol.	High Flex Leder	7S3SH046040028A01
	8 m	DDP	BSB 35-50 Burndy 8-pol.	High Flex Leder	7S3SH086040028A01
ABITIG® 26F	4 m	DDP	BSB 35-50 Burndy 8-pol.	Standard	7S3FK046040028A01
	8 m	DDP	BSB 35-50 Burndy 8-pol.	Standard	7S3FK086040028A01
	4 m	DDP	BSB 35-50 Burndy 8-pol.	High Flex Leder	7S3FH046040028A01
	8 m	DDP	BSB 35-50 Burndy 8-pol.	High Flex Leder	7S3FH086040028A01
ABITIG® 24G	4 m	DDP	BSB 35-50 Burndy 8-pol.	Standard	7S8SK046040028A01
	8 m	DDP	BSB 35-50 Burndy 8-pol.	Standard	7S8SK086040028A01
	4 m	DDP	BSB 35-50 Burndy 8-pol.	High Flex Leder	7S8SH046040028A01
	8 m	DDP	BSB 35-50 Burndy 8-pol.	High Flex Leder	7S8SH086040028A01
ABITIG® 200	4 m	DDP	BSB 35-50 Burndy 8-pol.	Standard	7T4SK046040028A01
	8 m	DDP	BSB 35-50 Burndy 8-pol.	Standard	7T4SK086040028A01
	4 m	DDP	BSB 35-50 Burndy 8-pol.	High Flex Leder	7T4SH046040028A01
	8 m	DDP	BSB 35-50 Burndy 8-pol.	High Flex Leder	7T4SH086040028A01
ABITIG® 200F	4 m	DDP	BSB 35-50 Burndy 8-pol.	Standard	7T4FK046040028A01
	8 m	DDP	BSB 35-50 Burndy 8-pol.	Standard	7T4FK086040028A01
	4 m	DDP	BSB 35-50 Burndy 8-pol.	High Flex Leder	7T4FH046040028A01
	8 m	DDP	BSB 35-50 Burndy 8-pol.	High Flex Leder	7T4FH086040028A01
ABITIG® 150	4 m	DDP	BSB 35-50 Burndy 8-pol.	Standard	7T6SK046040028A01
	8 m	DDP	BSB 35-50 Burndy 8-pol.	Standard	7T6SK086040028A01
	4 m	DDP	BSB 35-50 Burndy 8-pol.	High Flex Leder	7T6SH046040028A01
	8 m	DDP	BSB 35-50 Burndy 8-pol.	High Flex Leder	7T6SH086040028A01
ABITIG® 150F	4 m	DDP	BSB 35-50 Burndy 8-pol.	Standard	7T6FK046040028A01
	8 m	DDP	BSB 35-50 Burndy 8-pol.	Standard	7T6FK086040028A01
	4 m	DDP	BSB 35-50 Burndy 8-pol.	High Flex Leder	7T6FH046040028A01
	8 m	DDP	BSB 35-50 Burndy 8-pol.	High Flex Leder	7T6FH086040028A01

ABITIG®-Brennerpreisliste

passend für WIG-Stromquellen des Fabrikates „ewm“



Brennertyp	Länge	Schalterfunktion	maschinenseitiger Anschluss	Schlauchpaketausführung	Bestellnummer
ABITIG® 9	4 m	DDP	BSB 35-50 Tuchel 5-pol. + AMP 14-pol.	Standard	7S1SK046040023A01
	8 m	DDP	BSB 35-50 Tuchel 5-pol. + AMP 14-pol.	Standard	7S1SK086040023A01
	4 m	DDP	BSB 35-50 Tuchel 5-pol. + AMP 14-pol.	High Flex Leder	7S1SH046040023A01
	8 m	DDP	BSB 35-50 Tuchel 5-pol. + AMP 14-pol.	High Flex Leder	7S1SH086040023A01
ABITIG® 9F	4 m	DDP	BSB 35-50 Tuchel 5-pol. + AMP 14-pol.	Standard	7S1FK046040023A01
	8 m	DDP	BSB 35-50 Tuchel 5-pol. + AMP 14-pol.	Standard	7S1FK086040023A01
	4 m	DDP	BSB 35-50 Tuchel 5-pol. + AMP 14-pol.	High Flex Leder	7S1FH046040023A01
	8 m	DDP	BSB 35-50 Tuchel 5-pol. + AMP 14-pol.	High Flex Leder	7S1FH086040023A01
ABITIG® 17	4 m	DDP	BSB 35-50 Tuchel 5-pol. + AMP 14-pol.	Standard	7S2SK046040023A01
	8 m	DDP	BSB 35-50 Tuchel 5-pol. + AMP 14-pol.	Standard	7S2SK086040023A01
	4 m	DDP	BSB 35-50 Tuchel 5-pol. + AMP 14-pol.	High Flex Leder	7S2SH046040023A01
	8 m	DDP	BSB 35-50 Tuchel 5-pol. + AMP 14-pol.	High Flex Leder	7S2SH086040023A01
ABITIG® 17F	4 m	DDP	BSB 35-50 Tuchel 5-pol. + AMP 14-pol.	Standard	7S2FK046040023A01
	8 m	DDP	BSB 35-50 Tuchel 5-pol. + AMP 14-pol.	Standard	7S2FK086040023A01
	4 m	DDP	BSB 35-50 Tuchel 5-pol. + AMP 14-pol.	High Flex Leder	7S2FH046040023A01
	8 m	DDP	BSB 35-50 Tuchel 5-pol. + AMP 14-pol.	High Flex Leder	7S2FH086040023A01

Technische Änderungen vorbehalten • Verkaufspreise = unverbindliche Preisempfehlung - Angebot freibleibend • © Copyright

ABITIG®-Brennerpreisliste

passend für WIG-Stromquellen des Fabrikates „ewm“

Brennertyp	Länge	Schalterfunktion	maschinenseitiger Anschluss	Schlauchpaketausführung	Bestellnummer
ABITIG® 26	4 m	DDP	BSB 35-50 Tuchel 5-pol. + AMP 14-pol.	Standard	7S3SK046040023A01
	8 m	DDP	BSB 35-50 Tuchel 5-pol. + AMP 14-pol.	Standard	7S3SK086040023A01
	4 m	DDP	BSB 35-50 Tuchel 5-pol. + AMP 14-pol.	High Flex Leder	7S3SH046040023A01
	8 m	DDP	BSB 35-50 Tuchel 5-pol. + AMP 14-pol.	High Flex Leder	7S3SH086040023A01
ABITIG® 26F	4 m	DDP	BSB 35-50 Tuchel 5-pol. + AMP 14-pol.	Standard	7S3FK046040023A01
	8 m	DDP	BSB 35-50 Tuchel 5-pol. + AMP 14-pol.	Standard	7S3FK086040023A01
	4 m	DDP	BSB 35-50 Tuchel 5-pol. + AMP 14-pol.	High Flex Leder	7S3FH046040023A01
	8 m	DDP	BSB 35-50 Tuchel 5-pol. + AMP 14-pol.	High Flex Leder	7S3FH086040023A01
ABITIG® 24G	4 m	DDP	BSB 35-50 Tuchel 5-pol. + AMP 14-pol.	Standard	7S8SK046040023A01
	8 m	DDP	BSB 35-50 Tuchel 5-pol. + AMP 14-pol.	Standard	7S8SK086040023A01
	4 m	DDP	BSB 35-50 Tuchel 5-pol. + AMP 14-pol.	High Flex Leder	7S8SH046040023A01
	8 m	DDP	BSB 35-50 Tuchel 5-pol. + AMP 14-pol.	High Flex Leder	7S8SH086040023A01
ABITIG® 200	4 m	DDP	BSB 35-50 Tuchel 5-pol. + AMP 14-pol.	Standard	7T4SK046040023A01
	8 m	DDP	BSB 35-50 Tuchel 5-pol. + AMP 14-pol.	Standard	7T4SK086040023A01
	4 m	DDP	BSB 35-50 Tuchel 5-pol. + AMP 14-pol.	High Flex Leder	7T4SH046040023A01
	8 m	DDP	BSB 35-50 Tuchel 5-pol. + AMP 14-pol.	High Flex Leder	7T4SH086040023A01
ABITIG® 200F	4 m	DDP	BSB 35-50 Tuchel 5-pol. + AMP 14-pol.	Standard	7T4FK046040023A01
	8 m	DDP	BSB 35-50 Tuchel 5-pol. + AMP 14-pol.	Standard	7T4FK086040023A01
	4 m	DDP	BSB 35-50 Tuchel 5-pol. + AMP 14-pol.	High Flex Leder	7T4FH046040023A01
	8 m	DDP	BSB 35-50 Tuchel 5-pol. + AMP 14-pol.	High Flex Leder	7T4FH086040023A01
ABITIG® 150	4 m	DDP	BSB 35-50 Tuchel 5-pol. + AMP 14-pol.	Standard	7T6SK046040023A01
	8 m	DDP	BSB 35-50 Tuchel 5-pol. + AMP 14-pol.	Standard	7T6SK086040023A01
	4 m	DDP	BSB 35-50 Tuchel 5-pol. + AMP 14-pol.	High Flex Leder	7T6SH046040023A01
	8 m	DDP	BSB 35-50 Tuchel 5-pol. + AMP 14-pol.	High Flex Leder	7T6SH086040023A01
ABITIG® 150F	4 m	DDP	BSB 35-50 Tuchel 5-pol. + AMP 14-pol.	Standard	7T6FK046040023A01
	8 m	DDP	BSB 35-50 Tuchel 5-pol. + AMP 14-pol.	Standard	7T6FK086040023A01
	4 m	DDP	BSB 35-50 Tuchel 5-pol. + AMP 14-pol.	High Flex Leder	7T6FH046040023A01
	8 m	DDP	BSB 35-50 Tuchel 5-pol. + AMP 14-pol.	High Flex Leder	7T6FH086040023A01

ABITIG®-Brennerpreisliste

passend für WIG-Stromquellen des Fabrikates „ewm“ Up/Down



Brennertyp	Länge	Schalterfunktion	maschinenseitiger Anschluss	Schlauchpaketausführung	Bestellnummer
ABITIG® 9	4 m	UD	BSB 35-50 Burndy 8-pol.	Standard	7S1SK046150037B01
	8 m	UD	BSB 35-50 Burndy 8-pol.	Standard	7S1SK086150037B01
	4 m	UD	BSB 35-50 Burndy 8-pol.	High Flex Leder	7S1SH046150037B01
	8 m	UD	BSB 35-50 Burndy 8-pol.	High Flex Leder	7S1SH086150037B01

ABITIG® 9F	4 m	UD	BSB 35-50 Burndy 8-pol.	Standard	7S1FK046150037B01
	8 m	UD	BSB 35-50 Burndy 8-pol.	Standard	7S1FK086150037B01
	4 m	UD	BSB 35-50 Burndy 8-pol.	High Flex Leder	7S1FH046150037B01
	8 m	UD	BSB 35-50 Burndy 8-pol.	High Flex Leder	7S1FH086150037B01

ABITIG® 17	4 m	UD	BSB 35-50 Burndy 8-pol.	Standard	7S2SK046150037B01
	8 m	UD	BSB 35-50 Burndy 8-pol.	Standard	7S2SK086150037B01
	4 m	UD	BSB 35-50 Burndy 8-pol.	High Flex Leder	7S2SH046150037B01
	8 m	UD	BSB 35-50 Burndy 8-pol.	High Flex Leder	7S2SH086150037B01

ABITIG® 17F	4 m	UD	BSB 35-50 Burndy 8-pol.	Standard	7S2FK046150037B01
	8 m	UD	BSB 35-50 Burndy 8-pol.	Standard	7S2FK086150037B01
	4 m	UD	BSB 35-50 Burndy 8-pol.	High Flex Leder	7S2FH046150037B01
	8 m	UD	BSB 35-50 Burndy 8-pol.	High Flex Leder	7S2FH086150037B01

Technische Änderungen vorbehalten • Verkaufspreise = unverbindliche Preisempfehlung - Angebot freibleibend • © Copyright

ABITIG®-Brennerpreisliste

passend für WIG-Stromquellen des Fabrikates „ewm“ Up/Down

Brennertyp	Länge	Schalterfunktion	maschinenseitiger Anschluss	Schlauchpaketausführung	Bestellnummer
ABITIG® 26	4 m	UD	BSB 35-50 Burndy 8-pol.	Standard	7S3SK046150037B01
	8 m	UD	BSB 35-50 Burndy 8-pol.	Standard	7S3SK086150037B01
	4 m	UD	BSB 35-50 Burndy 8-pol.	High Flex Leder	7S3SH046150037B01
	8 m	UD	BSB 35-50 Burndy 8-pol.	High Flex Leder	7S3SH086150037B01

ABITIG® 26F	4 m	UD	BSB 35-50 Burndy 8-pol.	Standard	7S3FK046150037B01
	8 m	UD	BSB 35-50 Burndy 8-pol.	Standard	7S3FK086150037B01
	4 m	UD	BSB 35-50 Burndy 8-pol.	High Flex Leder	7S3FH046150037B01
	8 m	UD	BSB 35-50 Burndy 8-pol.	High Flex Leder	7S3FH086150037B01

ABITIG® 24G	4 m	UD	BSB 35-50 Burndy 8-pol.	Standard	7S8SK046150037B01
	8 m	UD	BSB 35-50 Burndy 8-pol.	Standard	7S8SK086150037B01
	4 m	UD	BSB 35-50 Burndy 8-pol.	High Flex Leder	7S8SH046150037B01
	8 m	UD	BSB 35-50 Burndy 8-pol.	High Flex Leder	7S8SH086150037B01

ABITIG® 200	4 m	UD	BSB 35-50 Burndy 8-pol.	Standard	7T4SK046150037B01
	8 m	UD	BSB 35-50 Burndy 8-pol.	Standard	7T4SK086150037B01
	4 m	UD	BSB 35-50 Burndy 8-pol.	High Flex Leder	7T4SH046150037B01
	8 m	UD	BSB 35-50 Burndy 8-pol.	High Flex Leder	7T4SH086150037B01

ABITIG® 200F	4 m	UD	BSB 35-50 Burndy 8-pol.	Standard	7T4FK046150037B01
	8 m	UD	BSB 35-50 Burndy 8-pol.	Standard	7T4FK086150037B01
	4 m	UD	BSB 35-50 Burndy 8-pol.	High Flex Leder	7T4FH046150037B01
	8 m	UD	BSB 35-50 Burndy 8-pol.	High Flex Leder	7T4FH086150037B01

ABITIG® 150	4 m	UD	BSB 35-50 Burndy 8-pol.	Standard	7T6SK046150037B01
	8 m	UD	BSB 35-50 Burndy 8-pol.	Standard	7T6SK086150037B01
	4 m	UD	BSB 35-50 Burndy 8-pol.	High Flex Leder	7T6SH046150037B01
	8 m	UD	BSB 35-50 Burndy 8-pol.	High Flex Leder	7T6SH086150037B01

ABITIG® 150F	4 m	UD	BSB 35-50 Burndy 8-pol.	Standard	7T6FK046150037B01
	8 m	UD	BSB 35-50 Burndy 8-pol.	Standard	7T6FK086150037B01
	4 m	UD	BSB 35-50 Burndy 8-pol.	High Flex Leder	7T6FH046150037B01
	8 m	UD	BSB 35-50 Burndy 8-pol.	High Flex Leder	7T6FH086150037B01

ABITIG®-Brennerpreisliste

passend für WIG-Stromquellen des Fabrikates „ewm“



Brennertyp	Länge	Schalterfunktion	maschinenseitiger Anschluss	Schlauchpaketausführung	Bestellnummer
ABITIG® 18	4 m	DD	BSB 35-50 Tuchel 5-pol.	Standard	7S4SK043020001A11
	8 m	DD	BSB 35-50 Tuchel 5-pol.	Standard	7S4SK083020001A11
	4 m	DD	BSB 35-50 Tuchel 5-pol.	High Flex Leder	7S4SH043020001A11
	8 m	DD	BSB 35-50 Tuchel 5-pol.	High Flex Leder	7S4SH083020001A11
ABITIG® 18F	4 m	DD	BSB 35-50 Tuchel 5-pol.	Standard	7S4FK043020001A11
	8 m	DD	BSB 35-50 Tuchel 5-pol.	Standard	7S4FK083020001A11
	4 m	DD	BSB 35-50 Tuchel 5-pol.	High Flex Leder	7S4FH043020001A11
	8 m	DD	BSB 35-50 Tuchel 5-pol.	High Flex Leder	7S4FH083020001A11
ABITIG® 20	4 m	DD	BSB 35-50 Tuchel 5-pol.	Standard	7S5SK043020001A11
	8 m	DD	BSB 35-50 Tuchel 5-pol.	Standard	7S5SK083020001A11
	4 m	DD	BSB 35-50 Tuchel 5-pol.	High Flex Leder	7S5SH043020001A11
	8 m	DD	BSB 35-50 Tuchel 5-pol.	High Flex Leder	7S5SH083020001A11
ABITIG® 20F	4 m	DD	BSB 35-50 Tuchel 5-pol.	Standard	7S5FK043020001A11
	8 m	DD	BSB 35-50 Tuchel 5-pol.	Standard	7S5FK083020001A11
	4 m	DD	BSB 35-50 Tuchel 5-pol.	High Flex Leder	7S5FH043020001A11
	8 m	DD	BSB 35-50 Tuchel 5-pol.	High Flex Leder	7S5FH083020001A11

Technische Änderungen vorbehalten • Verkaufspreise = unverbindliche Preisempfehlung - Angebot freibleibend • © Copyright

ABITIG®-Brennerpreisliste

passend für WIG-Stromquellen des Fabrikates „ewm“

Brennertyp	Länge	Schalterfunktion	maschinenseitiger Anschluss	Schlauchpaketausführung	Bestellnummer
ABITIG® 12-1	4 m	DD	BSB 35-50 Tuchel 5-pol.	Standard	7S6SK043020001A11
	8 m	DD	BSB 35-50 Tuchel 5-pol.	Standard	7S6SK083020001A11
	4 m	DD	BSB 35-50 Tuchel 5-pol.	High Flex Leder	7S6SH043020001A11
	8 m	DD	BSB 35-50 Tuchel 5-pol.	High Flex Leder	7S6SH083020001A11
ABITIG® 18SC	4 m	DD	BSB 35-50 Tuchel 5-pol.	Standard	7S7SK043020001A11
	8 m	DD	BSB 35-50 Tuchel 5-pol.	Standard	7S7SK083020001A11
	4 m	DD	BSB 35-50 Tuchel 5-pol.	High Flex Leder	7S7SH043020001A11
	8 m	DD	BSB 35-50 Tuchel 5-pol.	High Flex Leder	7S7SH083020001A11
ABITIG® 24W	4 m	DD	BSB 35-50 Tuchel 5-pol.	Standard	7S9SK043020001A11
	8 m	DD	BSB 35-50 Tuchel 5-pol.	Standard	7S9SK083020001A11
	4 m	DD	BSB 35-50 Tuchel 5-pol.	High Flex Leder	7S9SH043020001A11
	8 m	DD	BSB 35-50 Tuchel 5-pol.	High Flex Leder	7S9SH083020001A11
ABITIG® 450W	4 m	DD	BSB 35-50 Tuchel 5-pol.	Standard	7T5SK043020101A11
	8 m	DD	BSB 35-50 Tuchel 5-pol.	Standard	7T5SK083020101A11
	4 m	DD	BSB 35-50 Tuchel 5-pol.	High Flex Leder	7T5SH043020101A11
	8 m	DD	BSB 35-50 Tuchel 5-pol.	High Flex Leder	7T5SH083020101A11
ABITIG® 260W	4 m	DD	BSB 35-50 Tuchel 5-pol.	Standard	7T7SK043020101A11
	8 m	DD	BSB 35-50 Tuchel 5-pol.	Standard	7T7SK083020101A11
	4 m	DD	BSB 35-50 Tuchel 5-pol.	High Flex Leder	7T7SH043020101A11
	8 m	DD	BSB 35-50 Tuchel 5-pol.	High Flex Leder	7T7SH083020101A11
ABITIG® 450W SC	4 m	DD	BSB 35-50 Tuchel 5-pol.	Standard	
	8 m	DD	BSB 35-50 Tuchel 5-pol.	Standard	
	4 m	DD	BSB 35-50 Tuchel 5-pol.	High Flex Leder	7T8SH043020101A11
	8 m	DD	BSB 35-50 Tuchel 5-pol.	High Flex Leder	7T8SH083020101A11

ABITIG®-Brennerpreisliste

passend für WIG-Stromquellen des Fabrikates „ewm“

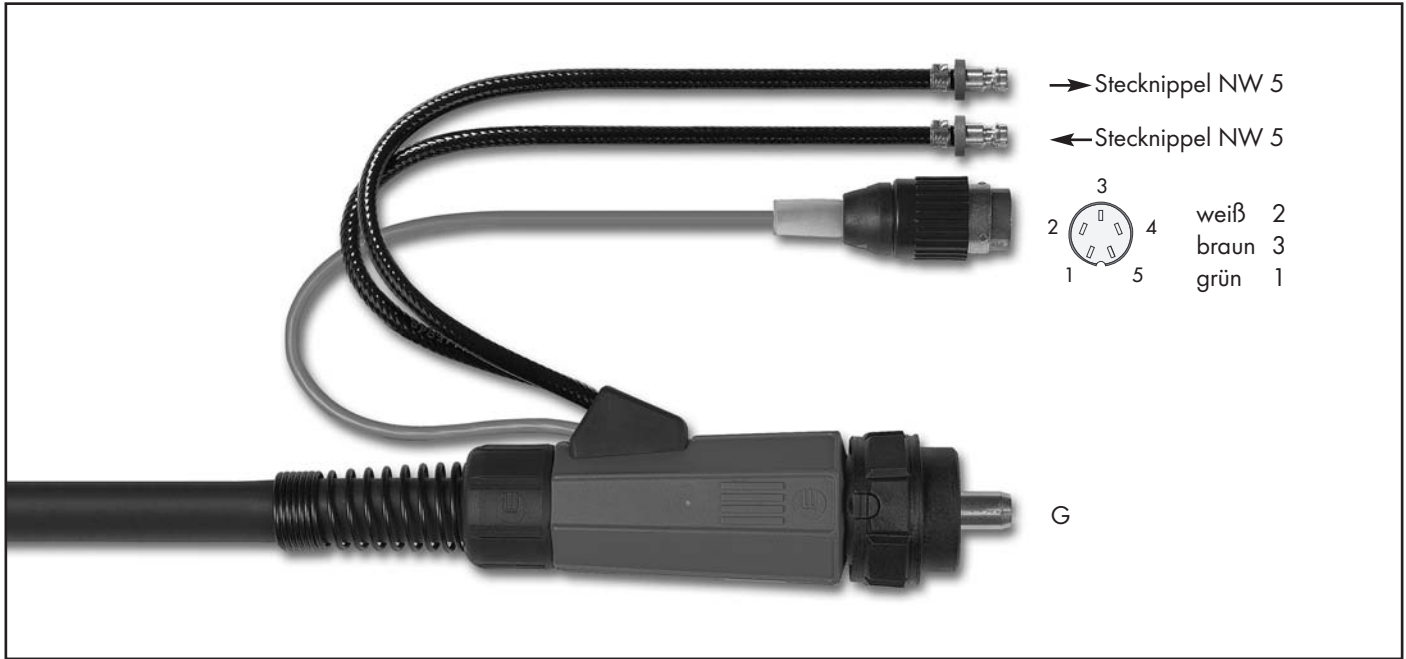

Brennertyp	Länge	Schalterfunktion	maschinenseitiger Anschluss	Schlauchpaketausführung	Bestellnummer
ABITIG® 18	4 m	DD	ZA - WZ-0 Tuchel 5-pol.	Standard	7S4SK043020301A12
	8 m	DD	ZA - WZ-0 Tuchel 5-pol.	Standard	7S4SK083020301A12
	4 m	DD	ZA - WZ-0 Tuchel 5-pol.	High Flex Leder	7S4SH043020301A12
	8 m	DD	ZA - WZ-0 Tuchel 5-pol.	High Flex Leder	7S4SH083020301A12
ABITIG® 18F	4 m	DD	ZA - WZ-0 Tuchel 5-pol.	Standard	7S4FK043020301A12
	8 m	DD	ZA - WZ-0 Tuchel 5-pol.	Standard	7S4FK083020301A12
	4 m	DD	ZA - WZ-0 Tuchel 5-pol.	High Flex Leder	7S4FH043020301A12
	8 m	DD	ZA - WZ-0 Tuchel 5-pol.	High Flex Leder	7S4FH083020301A12
ABITIG® 20	4 m	DD	ZA - WZ-0 Tuchel 5-pol.	Standard	7S5SK043020301A12
	8 m	DD	ZA - WZ-0 Tuchel 5-pol.	Standard	7S5SK083020301A12
	4 m	DD	ZA - WZ-0 Tuchel 5-pol.	High Flex Leder	7S5SH043020301A12
	8 m	DD	ZA - WZ-0 Tuchel 5-pol.	High Flex Leder	7S5SH083020301A12
ABITIG® 20F	4 m	DD	ZA - WZ-0 Tuchel 5-pol.	Standard	7S5FK043020301A12
	8 m	DD	ZA - WZ-0 Tuchel 5-pol.	Standard	7S5FK083020301A12
	4 m	DD	ZA - WZ-0 Tuchel 5-pol.	High Flex Leder	7S5FH043020301A12
	8 m	DD	ZA - WZ-0 Tuchel 5-pol.	High Flex Leder	7S5FH083020301A12

Technische Änderungen vorbehalten • Verkaufspreise = unverbindliche Preisempfehlung - Angebot freibleibend • © Copyright

ABITIG®-Brennerpreisliste

passend für WIG-Stromquellen des Fabrikates „ewm“

Brennertyp	Länge	Schalterfunktion	maschinenseitiger Anschluss	Schlauchpaketausführung	Bestellnummer
ABITIG® 12-1	4 m	DD	ZA - WZ-0 Tuchel 5-pol.	Standard	7S6SK043020301A12
	8 m	DD	ZA - WZ-0 Tuchel 5-pol.	Standard	7S6SK083020301A12
	4 m	DD	ZA - WZ-0 Tuchel 5-pol.	High Flex Leder	7S6SH043020301A12
	8 m	DD	ZA - WZ-0 Tuchel 5-pol.	High Flex Leder	7S6SH083020301A12
<hr/>					
ABITIG® 18SC	4 m	DD	ZA - WZ-0 Tuchel 5-pol.	Standard	7S7SK043020301A12
	8 m	DD	ZA - WZ-0 Tuchel 5-pol.	Standard	7S7SK083020301A12
	4 m	DD	ZA - WZ-0 Tuchel 5-pol.	High Flex Leder	7S7SH043020301A12
	8 m	DD	ZA - WZ-0 Tuchel 5-pol.	High Flex Leder	7S7SH083020301A12
<hr/>					
ABITIG® 24W	4 m	DD	ZA - WZ-0 Tuchel 5-pol.	Standard	7S9SK043020301A12
	8 m	DD	ZA - WZ-0 Tuchel 5-pol.	Standard	7S9SK083020301A12
	4 m	DD	ZA - WZ-0 Tuchel 5-pol.	High Flex Leder	7S9SH043020301A12
	8 m	DD	ZA - WZ-0 Tuchel 5-pol.	High Flex Leder	7S9SH083020301A12
<hr/>					
ABITIG® 450W	4 m	DD	ZA - WZ-0 Tuchel 5-pol.	Standard	7T5SK043020301A12
	8 m	DD	ZA - WZ-0 Tuchel 5-pol.	Standard	7T5SK083020301A12
	4 m	DD	ZA - WZ-0 Tuchel 5-pol.	High Flex Leder	7T5SH043020301A12
	8 m	DD	ZA - WZ-0 Tuchel 5-pol.	High Flex Leder	7T5SH083020301A12
<hr/>					
ABITIG® 260W	4 m	DD	ZA - WZ-0 Tuchel 5-pol.	Standard	7T7SK043020301A12
	8 m	DD	ZA - WZ-0 Tuchel 5-pol.	Standard	7T7SK083020301A12
	4 m	DD	ZA - WZ-0 Tuchel 5-pol.	High Flex Leder	7T7SH043020301A12
	8 m	DD	ZA - WZ-0 Tuchel 5-pol.	High Flex Leder	7T7SH083020301A12
<hr/>					
ABITIG® 450W SC	4 m	DD	ZA - WZ-0 Tuchel 5-pol.	Standard	
	8 m	DD	ZA - WZ-0 Tuchel 5-pol.	Standard	
	4 m	DD	ZA - WZ-0 Tuchel 5-pol.	High Flex Leder	7T8SH043020301A12
	8 m	DD	ZA - WZ-0 Tuchel 5-pol.	High Flex Leder	7T8SH083020301A12

ABITIG®-Brennerpreisliste

passend für WIG-Stromquellen des Fabrikates „ewm“



Brennertyp	Länge	Schalterfunktion	maschinenseitiger Anschluss	Schlauchpaketausführung	Bestellnummer
ABITIG® 18	4 m	DDP	BSB 35-50 Burndy 8-pol.	Standard	7S4SK046040028A11
	8 m	DDP	BSB 35-50 Burndy 8-pol.	Standard	7S4SK086040028A11
	4 m	DDP	BSB 35-50 Burndy 8-pol.	High Flex Leder	7S4SH046040028A11
	8 m	DDP	BSB 35-50 Burndy 8-pol.	High Flex Leder	7S4SH086040028A11
ABITIG® 18F	4 m	DDP	BSB 35-50 Burndy 8-pol.	Standard	7S4FK046040028A11
	8 m	DDP	BSB 35-50 Burndy 8-pol.	Standard	7S4FK086040028A11
	4 m	DDP	BSB 35-50 Burndy 8-pol.	High Flex Leder	7S4FH046040028A11
	8 m	DDP	BSB 35-50 Burndy 8-pol.	High Flex Leder	7S4FH086040028A11
ABITIG® 20	4 m	DDP	BSB 35-50 Burndy 8-pol.	Standard	7S5SK046040028A11
	8 m	DDP	BSB 35-50 Burndy 8-pol.	Standard	7S5SK086040028A11
	4 m	DDP	BSB 35-50 Burndy 8-pol.	High Flex Leder	7S5SH046040028A11
	8 m	DDP	BSB 35-50 Burndy 8-pol.	High Flex Leder	7S5SH086040028A11
ABITIG® 20F	4 m	DDP	BSB 35-50 Burndy 8-pol.	Standard	7S5FK046040028A11
	8 m	DDP	BSB 35-50 Burndy 8-pol.	Standard	7S5FK086040028A11
	4 m	DDP	BSB 35-50 Burndy 8-pol.	High Flex Leder	7S5FH046040028A11
	8 m	DDP	BSB 35-50 Burndy 8-pol.	High Flex Leder	7S5FH086040028A11

Technische Änderungen vorbehalten • Verkaufspreise = unverbindliche Preisempfehlung - Angebot freibleibend • © Copyright

ABITIG®-Brennerpreisliste

passend für WIG-Stromquellen des Fabrikates „ewm“

Brennertyp	Länge	Schalterfunktion	maschinenseitiger Anschluss	Schlauchpaketausführung	Bestellnummer
ABITIG® 12-1	4 m	DDP	BSB 35-50 Burndy 8-pol.	Standard	7S6SK046040028A11
	8 m	DDP	BSB 35-50 Burndy 8-pol.	Standard	7S6SK086040028A11
	4 m	DDP	BSB 35-50 Burndy 8-pol.	High Flex Leder	7S6SH046040028A11
	8 m	DDP	BSB 35-50 Burndy 8-pol.	High Flex Leder	7S6SH086040028A11

ABITIG® 18SC	4 m	DDP	BSB 35-50 Burndy 8-pol.	Standard	7S7SK046040028A11
	8 m	DDP	BSB 35-50 Burndy 8-pol.	Standard	7S7SK086040028A11
	4 m	DDP	BSB 35-50 Burndy 8-pol.	High Flex Leder	7S7SH046040028A11
	8 m	DDP	BSB 35-50 Burndy 8-pol.	High Flex Leder	7S7SH086040028A11

ABITIG® 24W	4 m	DDP	BSB 35-50 Burndy 8-pol.	Standard	7S9SK046040028A11
	8 m	DDP	BSB 35-50 Burndy 8-pol.	Standard	7S9SK086040028A11
	4 m	DDP	BSB 35-50 Burndy 8-pol.	High Flex Leder	7S9SH046040028A11
	8 m	DDP	BSB 35-50 Burndy 8-pol.	High Flex Leder	7S9SH086040028A11

ABITIG® 450W	4 m	DDP	BSB 35-50 Burndy 8-pol.	Standard	7T5SK046040128A11
	8 m	DDP	BSB 35-50 Burndy 8-pol.	Standard	7T5SK086040128A11
	4 m	DDP	BSB 35-50 Burndy 8-pol.	High Flex Leder	7T5SH046040128A11
	8 m	DDP	BSB 35-50 Burndy 8-pol.	High Flex Leder	7T5SH086040128A11

ABITIG® 260W	4 m	DDP	BSB 35-50 Burndy 8-pol.	Standard	7T7SK046040128A11
	8 m	DDP	BSB 35-50 Burndy 8-pol.	Standard	7T7SK086040128A11
	4 m	DDP	BSB 35-50 Burndy 8-pol.	High Flex Leder	7T7SH046040128A11
	8 m	DDP	BSB 35-50 Burndy 8-pol.	High Flex Leder	7T7SH086040128A11

ABITIG® 450W SC	4 m	DDP	BSB 35-50 Burndy 8-pol.	Standard	
	8 m	DDP	BSB 35-50 Burndy 8-pol.	Standard	
	4 m	DDP	BSB 35-50 Burndy 8-pol.	High Flex Leder	7T8SH046040128A11
	8 m	DDP	BSB 35-50 Burndy 8-pol.	High Flex Leder	7T8SH086040128A11

ABITIG®-Brennerpreisliste

passend für WIG-Stromquellen des Fabrikates „ewm“



Brennertyp	Länge	Schalterfunktion	maschinenseitiger Anschluss	Schlauchpaketausführung	Bestellnummer
ABITIG® 18	4 m	DDP	BSB 35-50 Tuchel 5-pol. + AMP 14-pol.	Standard	7S4SK046040023A11
	8 m	DDP	BSB 35-50 Tuchel 5-pol. + AMP 14-pol.	Standard	7S4SK086040023A11
	4 m	DDP	BSB 35-50 Tuchel 5-pol. + AMP 14-pol.	High Flex Leder	7S4SH046040023A11
	8 m	DDP	BSB 35-50 Tuchel 5-pol. + AMP 14-pol.	High Flex Leder	7S4SH086040023A11
ABITIG® 18F	4 m	DDP	BSB 35-50 Tuchel 5-pol. + AMP 14-pol.	Standard	7S4FK046040023A11
	8 m	DDP	BSB 35-50 Tuchel 5-pol. + AMP 14-pol.	Standard	7S4FK086040023A11
	4 m	DDP	BSB 35-50 Tuchel 5-pol. + AMP 14-pol.	High Flex Leder	7S4FH046040023A11
	8 m	DDP	BSB 35-50 Tuchel 5-pol. + AMP 14-pol.	High Flex Leder	7S4FH086040023A11
ABITIG® 20	4 m	DDP	BSB 35-50 Tuchel 5-pol. + AMP 14-pol.	Standard	7S5SK046040023A11
	8 m	DDP	BSB 35-50 Tuchel 5-pol. + AMP 14-pol.	Standard	7S5SK086040023A11
	4 m	DDP	BSB 35-50 Tuchel 5-pol. + AMP 14-pol.	High Flex Leder	7S5SH046040023A11
	8 m	DDP	BSB 35-50 Tuchel 5-pol. + AMP 14-pol.	High Flex Leder	7S5SH086040023A11
ABITIG® 20F	4 m	DDP	BSB 35-50 Tuchel 5-pol. + AMP 14-pol.	Standard	7S5FK046040023A11
	8 m	DDP	BSB 35-50 Tuchel 5-pol. + AMP 14-pol.	Standard	7S5FK086040023A11
	4 m	DDP	BSB 35-50 Tuchel 5-pol. + AMP 14-pol.	High Flex Leder	7S5FH046040023A11
	8 m	DDP	BSB 35-50 Tuchel 5-pol. + AMP 14-pol.	High Flex Leder	7S5FH086040023A11

Technische Änderungen vorbehalten • Verkaufspreise = unverbindliche Preisempfehlung - Angebot freibleibend • © Copyright

ABITIG®-Brennerpreisliste

passend für WIG-Stromquellen des Fabrikates „ewm“

Brennertyp	Länge	Schalterfunktion	maschinenseitiger Anschluss	Schlauchpaketausführung	Bestellnummer
ABITIG® 12-1	4 m	DDP	BSB 35-50 Tuchel 5-pol. + AMP 14-pol.	Standard	7S6SK046040023A11
	8 m	DDP	BSB 35-50 Tuchel 5-pol. + AMP 14-pol.	Standard	7S6SK086040023A11
	4 m	DDP	BSB 35-50 Tuchel 5-pol. + AMP 14-pol.	High Flex Leder	7S6SH046040023A11
	8 m	DDP	BSB 35-50 Tuchel 5-pol. + AMP 14-pol.	High Flex Leder	7S6SH086040023A11
ABITIG® 18SC	4 m	DDP	BSB 35-50 Tuchel 5-pol. + AMP 14-pol.	Standard	7S7SK046040023A11
	8 m	DDP	BSB 35-50 Tuchel 5-pol. + AMP 14-pol.	Standard	7S7SK086040023A11
	4 m	DDP	BSB 35-50 Tuchel 5-pol. + AMP 14-pol.	High Flex Leder	7S7SH046040023A11
	8 m	DDP	BSB 35-50 Tuchel 5-pol. + AMP 14-pol.	High Flex Leder	7S7SH086040023A11
ABITIG® 24W	4 m	DDP	BSB 35-50 Tuchel 5-pol. + AMP 14-pol.	Standard	7S9SK046040023A11
	8 m	DDP	BSB 35-50 Tuchel 5-pol. + AMP 14-pol.	Standard	7S9SK086040023A11
	4 m	DDP	BSB 35-50 Tuchel 5-pol. + AMP 14-pol.	High Flex Leder	7S9SH046040023A11
	8 m	DDP	BSB 35-50 Tuchel 5-pol. + AMP 14-pol.	High Flex Leder	7S9SH086040023A11
ABITIG® 450W	4 m	DDP	BSB 35-50 Tuchel 5-pol. + AMP 14-pol.	Standard	7T5SK046040123A11
	8 m	DDP	BSB 35-50 Tuchel 5-pol. + AMP 14-pol.	Standard	7T5SK086040123A11
	4 m	DDP	BSB 35-50 Tuchel 5-pol. + AMP 14-pol.	High Flex Leder	7T5SH046040123A11
	8 m	DDP	BSB 35-50 Tuchel 5-pol. + AMP 14-pol.	High Flex Leder	7T5SH086040123A11
ABITIG® 260W	4 m	DDP	BSB 35-50 Tuchel 5-pol. + AMP 14-pol.	Standard	7T7SK046040123A11
	8 m	DDP	BSB 35-50 Tuchel 5-pol. + AMP 14-pol.	Standard	7T7SK086040123A11
	4 m	DDP	BSB 35-50 Tuchel 5-pol. + AMP 14-pol.	High Flex Leder	7T7SH046040123A11
	8 m	DDP	BSB 35-50 Tuchel 5-pol. + AMP 14-pol.	High Flex Leder	7T7SH086040123A11
ABITIG® 450W SC	4 m	DDP	BSB 35-50 Tuchel 5-pol. + AMP 14-pol.	Standard	
	8 m	DDP	BSB 35-50 Tuchel 5-pol. + AMP 14-pol.	Standard	
	4 m	DDP	BSB 35-50 Tuchel 5-pol. + AMP 14-pol.	High Flex Leder	7T8SH046040123A11
	8 m	DDP	BSB 35-50 Tuchel 5-pol. + AMP 14-pol.	High Flex Leder	7T8SH086040123A11

ABITIG®-Brennerpreisliste

passend für WIG-Stromquellen des Fabrikates „ewm“ Up/Down



Brennertyp	Länge	Schalterfunktion	maschinenseitiger Anschluss	Schlauchpaketausführung	Bestellnummer
ABITIG® 18	4 m	UD	BSB 35-50 Burndy 8-pol.	Standard	7S4SK046150037B11
	8 m	UD	BSB 35-50 Burndy 8-pol.	Standard	7S4SK086150037B11
	4 m	UD	BSB 35-50 Burndy 8-pol.	High Flex Leder	7S4SH046150037B11
	8 m	UD	BSB 35-50 Burndy 8-pol.	High Flex Leder	7S4SH086150037B11
ABITIG® 18F	4 m	UD	BSB 35-50 Burndy 8-pol.	Standard	7S4FK046150037B11
	8 m	UD	BSB 35-50 Burndy 8-pol.	Standard	7S4FK086150037B11
	4 m	UD	BSB 35-50 Burndy 8-pol.	High Flex Leder	7S4FH046150037B11
	8 m	UD	BSB 35-50 Burndy 8-pol.	High Flex Leder	7S4FH086150037B11
ABITIG® 20	4 m	UD	BSB 35-50 Burndy 8-pol.	Standard	7S5SK046150037B11
	8 m	UD	BSB 35-50 Burndy 8-pol.	Standard	7S5SK086150037B11
	4 m	UD	BSB 35-50 Burndy 8-pol.	High Flex Leder	7S5SH046150037B11
	8 m	UD	BSB 35-50 Burndy 8-pol.	High Flex Leder	7S5SH086150037B11
ABITIG® 20F	4 m	UD	BSB 35-50 Burndy 8-pol.	Standard	7S5FK046150037B11
	8 m	UD	BSB 35-50 Burndy 8-pol.	Standard	7S5FK086150037B11
	4 m	UD	BSB 35-50 Burndy 8-pol.	High Flex Leder	7S5FH046150037B11
	8 m	UD	BSB 35-50 Burndy 8-pol.	High Flex Leder	7S5FH086150037B11

Technische Änderungen vorbehalten • Verkaufspreise = unverbindliche Preisempfehlung - Angebot freibleibend • © Copyright

ABITIG®-Brennerpreisliste

passend für WIG-Stromquellen des Fabrikates „ewm“ Up/Down

Brennertyp	Länge	Schalterfunktion	maschinenseitiger Anschluss	Schlauchpaketausführung	Bestellnummer
ABITIG® 12-1	4 m	UD	BSB 35-50 Burndy 8-pol.	Standard	7S6SK046150037B11
	8 m	UD	BSB 35-50 Burndy 8-pol.	Standard	7S6SK086150037B11
	4 m	UD	BSB 35-50 Burndy 8-pol.	High Flex Leder	7S6SH046150037B11
	8 m	UD	BSB 35-50 Burndy 8-pol.	High Flex Leder	7S6SH086150037B11
ABITIG® 18SC	4 m	UD	BSB 35-50 Burndy 8-pol.	Standard	7S7SK046150037B11
	8 m	UD	BSB 35-50 Burndy 8-pol.	Standard	7S7SK086150037B11
	4 m	UD	BSB 35-50 Burndy 8-pol.	High Flex Leder	7S7SH046150037B11
	8 m	UD	BSB 35-50 Burndy 8-pol.	High Flex Leder	7S7SH086150037B11
ABITIG® 24W	4 m	UD	BSB 35-50 Burndy 8-pol.	Standard	7S9SK046150037B11
	8 m	UD	BSB 35-50 Burndy 8-pol.	Standard	7S9SK086150037B11
	4 m	UD	BSB 35-50 Burndy 8-pol.	High Flex Leder	7S9SH046150037B11
	8 m	UD	BSB 35-50 Burndy 8-pol.	High Flex Leder	7S9SH086150037B11
ABITIG® 450W	4 m	UD	BSB 35-50 Burndy 8-pol.	Standard	7T5SK046150137B11
	8 m	UD	BSB 35-50 Burndy 8-pol.	Standard	7T5SK086150137B11
	4 m	UD	BSB 35-50 Burndy 8-pol.	High Flex Leder	7T5SH046150137B11
	8 m	UD	BSB 35-50 Burndy 8-pol.	High Flex Leder	7T5SH086150137B11
ABITIG® 260W	4 m	UD	BSB 35-50 Burndy 8-pol.	Standard	7T7SK046150137B11
	8 m	UD	BSB 35-50 Burndy 8-pol.	Standard	7T7SK086150137B11
	4 m	UD	BSB 35-50 Burndy 8-pol.	High Flex Leder	7T7SH046150137B11
	8 m	UD	BSB 35-50 Burndy 8-pol.	High Flex Leder	7T7SH086150137B11
ABITIG® 450W SC	4 m	UD	BSB 35-50 Burndy 8-pol.	Standard	
	8 m	UD	BSB 35-50 Burndy 8-pol.	Standard	
	4 m	UD	BSB 35-50 Burndy 8-pol.	High Flex Leder	7T8SH046150137B11
	8 m	UD	BSB 35-50 Burndy 8-pol.	High Flex Leder	7T8SH086150137B11

ABITIG®-Brennerpreisliste

passend für WIG-Stromquellen des Fabrikates „fronius“



Brennertyp	Länge	Schalterfunktion	maschinenseitiger Anschluss	Schlauchpaketausführung	Bestellnummer
ABITIG® 9	4 m	DD	EA Rechtecksteckverbinder 9-pol.	Standard	7S1SK043020615A00
	8 m	DD	EA Rechtecksteckverbinder 9-pol.	Standard	7S1SK083020615A00
	4 m	DD	EA Rechtecksteckverbinder 9-pol.	High Flex Leder	7S1SH043020615A00
	8 m	DD	EA Rechtecksteckverbinder 9-pol.	High Flex Leder	7S1SH083020615A00

ABITIG® 9F	4 m	DD	EA Rechtecksteckverbinder 9-pol.	Standard	7S1FK043020615A00
	8 m	DD	EA Rechtecksteckverbinder 9-pol.	Standard	7S1FK083020615A00
	4 m	DD	EA Rechtecksteckverbinder 9-pol.	High Flex Leder	7S1FH043020615A00
	8 m	DD	EA Rechtecksteckverbinder 9-pol.	High Flex Leder	7S1FH083020615A00

ABITIG® 17	4 m	DD	EA Rechtecksteckverbinder 9-pol.	Standard	7S2SK043020615A00
	8 m	DD	EA Rechtecksteckverbinder 9-pol.	Standard	7S2SK083020615A00
	4 m	DD	EA Rechtecksteckverbinder 9-pol.	High Flex Leder	7S2SH043020615A00
	8 m	DD	EA Rechtecksteckverbinder 9-pol.	High Flex Leder	7S2SH083020615A00

ABITIG® 17F	4 m	DD	EA Rechtecksteckverbinder 9-pol.	Standard	7S2FK043020615A00
	8 m	DD	EA Rechtecksteckverbinder 9-pol.	Standard	7S2FK083020615A00
	4 m	DD	EA Rechtecksteckverbinder 9-pol.	High Flex Leder	7S2FH043020615A00
	8 m	DD	EA Rechtecksteckverbinder 9-pol.	High Flex Leder	7S2FH083020615A00

Technische Änderungen vorbehalten • Verkaufspreise = unverbindliche Preisempfehlung - Angebot freibleibend • © Copyright

ABITIG®-Brennerpreisliste

passend für WIG-Stromquellen des Fabrikates „fronius“

Brennertyp	Länge	Schalterfunktion	maschinenseitiger Anschluss	Schlauchpaketausführung	Bestellnummer
ABITIG® 26	4 m	DD	EA Rechtecksteckverbinder 9-pol.	Standard	7S3SK043020615A00
	8 m	DD	EA Rechtecksteckverbinder 9-pol.	Standard	7S3SK083020615A00
	4 m	DD	EA Rechtecksteckverbinder 9-pol.	High Flex Leder	7S3SH043020615A00
	8 m	DD	EA Rechtecksteckverbinder 9-pol.	High Flex Leder	7S3SH083020615A00
ABITIG® 26F	4 m	DD	EA Rechtecksteckverbinder 9-pol.	Standard	7S3FK043020615A00
	8 m	DD	EA Rechtecksteckverbinder 9-pol.	Standard	7S3FK083020615A00
	4 m	DD	EA Rechtecksteckverbinder 9-pol.	High Flex Leder	7S3FH043020615A00
	8 m	DD	EA Rechtecksteckverbinder 9-pol.	High Flex Leder	7S3FH083020615A00
ABITIG® 24G	4 m	DD	EA Rechtecksteckverbinder 9-pol.	Standard	7S8SK043020615A00
	8 m	DD	EA Rechtecksteckverbinder 9-pol.	Standard	7S8SK083020615A00
	4 m	DD	EA Rechtecksteckverbinder 9-pol.	High Flex Leder	7S8SH043020615A00
	8 m	DD	EA Rechtecksteckverbinder 9-pol.	High Flex Leder	7S8SH083020615A00
ABITIG® 200	4 m	DD	EA Rechtecksteckverbinder 9-pol.	Standard	7T4SK043020615A00
	8 m	DD	EA Rechtecksteckverbinder 9-pol.	Standard	7T4SK083020615A00
	4 m	DD	EA Rechtecksteckverbinder 9-pol.	High Flex Leder	7T4SH043020615A00
	8 m	DD	EA Rechtecksteckverbinder 9-pol.	High Flex Leder	7T4SH083020615A00
ABITIG® 200F	4 m	DD	EA Rechtecksteckverbinder 9-pol.	Standard	7T4FK043020615A00
	8 m	DD	EA Rechtecksteckverbinder 9-pol.	Standard	7T4FK083020615A00
	4 m	DD	EA Rechtecksteckverbinder 9-pol.	High Flex Leder	7T4FH043020615A00
	8 m	DD	EA Rechtecksteckverbinder 9-pol.	High Flex Leder	7T4FH083020615A00
ABITIG® 150	4 m	DD	EA Rechtecksteckverbinder 9-pol.	Standard	7T6SK043020615A00
	8 m	DD	EA Rechtecksteckverbinder 9-pol.	Standard	7T6SK083020615A00
	4 m	DD	EA Rechtecksteckverbinder 9-pol.	High Flex Leder	7T6SH043020615A00
	8 m	DD	EA Rechtecksteckverbinder 9-pol.	High Flex Leder	7T6SH083020615A00
ABITIG® 150F	4 m	DD	EA Rechtecksteckverbinder 9-pol.	Standard	7T6FK043020615A00
	8 m	DD	EA Rechtecksteckverbinder 9-pol.	Standard	7T6FK083020615A00
	4 m	DD	EA Rechtecksteckverbinder 9-pol.	High Flex Leder	7T6FH043020615A00
	8 m	DD	EA Rechtecksteckverbinder 9-pol.	High Flex Leder	7T6FH083020615A00

ABITIG®-Brennerpreisliste

passend für WIG-Stromquellen des Fabrikates „fronius“ Up/Down



Brennertyp	Länge	Schalterfunktion	maschinenseitiger Anschluss	Schlauchpaketausführung	Bestellnummer
ABITIG® 9	4 m	UD	EA Rechtecksteckverbinder 9-pol.	Standard	7S1SK046150616A00
	8 m	UD	EA Rechtecksteckverbinder 9-pol.	Standard	7S1SK086150616A00
	4 m	UD	EA Rechtecksteckverbinder 9-pol.	High Flex Leder	7S1SH046150616A00
	8 m	UD	EA Rechtecksteckverbinder 9-pol.	High Flex Leder	7S1SH086150616A00

ABITIG® 9F	4 m	UD	EA Rechtecksteckverbinder 9-pol.	Standard	7S1FK046150616A00
	8 m	UD	EA Rechtecksteckverbinder 9-pol.	Standard	7S1FK086150616A00
	4 m	UD	EA Rechtecksteckverbinder 9-pol.	High Flex Leder	7S1FH046150616A00
	8 m	UD	EA Rechtecksteckverbinder 9-pol.	High Flex Leder	7S1FH086150616A00

ABITIG® 17	4 m	UD	EA Rechtecksteckverbinder 9-pol.	Standard	7S2SK046150616A00
	8 m	UD	EA Rechtecksteckverbinder 9-pol.	Standard	7S2SK086150616A00
	4 m	UD	EA Rechtecksteckverbinder 9-pol.	High Flex Leder	7S2SH046150616A00
	8 m	UD	EA Rechtecksteckverbinder 9-pol.	High Flex Leder	7S2SH086150616A00

ABITIG® 17F	4 m	UD	EA Rechtecksteckverbinder 9-pol.	Standard	7S2FK046150616A00
	8 m	UD	EA Rechtecksteckverbinder 9-pol.	Standard	7S2FK086150616A00
	4 m	UD	EA Rechtecksteckverbinder 9-pol.	High Flex Leder	7S2FH046150616A00
	8 m	UD	EA Rechtecksteckverbinder 9-pol.	High Flex Leder	7S2FH086150616A00

ABITIG®-Brennerpreisliste

passend für WIG-Stromquellen des Fabrikates „fronius“ Up/Down

Brennertyp	Länge	Schalterfunktion	maschinenseitiger Anschluss	Schlauchpaketausführung	Bestellnummer
ABITIG® 26	4 m	UD	EA Rechtecksteckverbinder 9-pol.	Standard	7S3SK046150616A00
	8 m	UD	EA Rechtecksteckverbinder 9-pol.	Standard	7S3SK086150616A00
	4 m	UD	EA Rechtecksteckverbinder 9-pol.	High Flex Leder	7S3SH046150616A00
	8 m	UD	EA Rechtecksteckverbinder 9-pol.	High Flex Leder	7S3SH086150616A00
ABITIG® 26F	4 m	UD	EA Rechtecksteckverbinder 9-pol.	Standard	7S3FK046150616A00
	8 m	UD	EA Rechtecksteckverbinder 9-pol.	Standard	7S3FK086150616A00
	4 m	UD	EA Rechtecksteckverbinder 9-pol.	High Flex Leder	7S3FH046150616A00
	8 m	UD	EA Rechtecksteckverbinder 9-pol.	High Flex Leder	7S3FH086150616A00
ABITIG® 24G	4 m	UD	EA Rechtecksteckverbinder 9-pol.	Standard	7S8SK046150616A00
	8 m	UD	EA Rechtecksteckverbinder 9-pol.	Standard	7S8SK086150616A00
	4 m	UD	EA Rechtecksteckverbinder 9-pol.	High Flex Leder	7S8SH046150616A00
	8 m	UD	EA Rechtecksteckverbinder 9-pol.	High Flex Leder	7S8SH086150616A00
ABITIG® 200	4 m	UD	EA Rechtecksteckverbinder 9-pol.	Standard	7T4SK046150616A00
	8 m	UD	EA Rechtecksteckverbinder 9-pol.	Standard	7T4SK086150616A00
	4 m	UD	EA Rechtecksteckverbinder 9-pol.	High Flex Leder	7T4SH046150616A00
	8 m	UD	EA Rechtecksteckverbinder 9-pol.	High Flex Leder	7T4SH086150616A00
ABITIG® 200F	4 m	UD	EA Rechtecksteckverbinder 9-pol.	Standard	7T4FK046150616A00
	8 m	UD	EA Rechtecksteckverbinder 9-pol.	Standard	7T4FK086150616A00
	4 m	UD	EA Rechtecksteckverbinder 9-pol.	High Flex Leder	7T4FH046150616A00
	8 m	UD	EA Rechtecksteckverbinder 9-pol.	High Flex Leder	7T4FH086150616A00
ABITIG® 150	4 m	UD	EA Rechtecksteckverbinder 9-pol.	Standard	7T6SK046150616A00
	8 m	UD	EA Rechtecksteckverbinder 9-pol.	Standard	7T6SK086150616A00
	4 m	UD	EA Rechtecksteckverbinder 9-pol.	High Flex Leder	7T6SH046150616A00
	8 m	UD	EA Rechtecksteckverbinder 9-pol.	High Flex Leder	7T6SH086150616A00
ABITIG® 150F	4 m	UD	EA Rechtecksteckverbinder 9-pol.	Standard	7T6FK046150616A00
	8 m	UD	EA Rechtecksteckverbinder 9-pol.	Standard	7T6FK086150616A00
	4 m	UD	EA Rechtecksteckverbinder 9-pol.	High Flex Leder	7T6FH046150616A00
	8 m	UD	EA Rechtecksteckverbinder 9-pol.	High Flex Leder	7T6FH086150616A00

ABITIG®-Brennerpreisliste

passend für WIG-Stromquellen des Fabrikates „fronius“

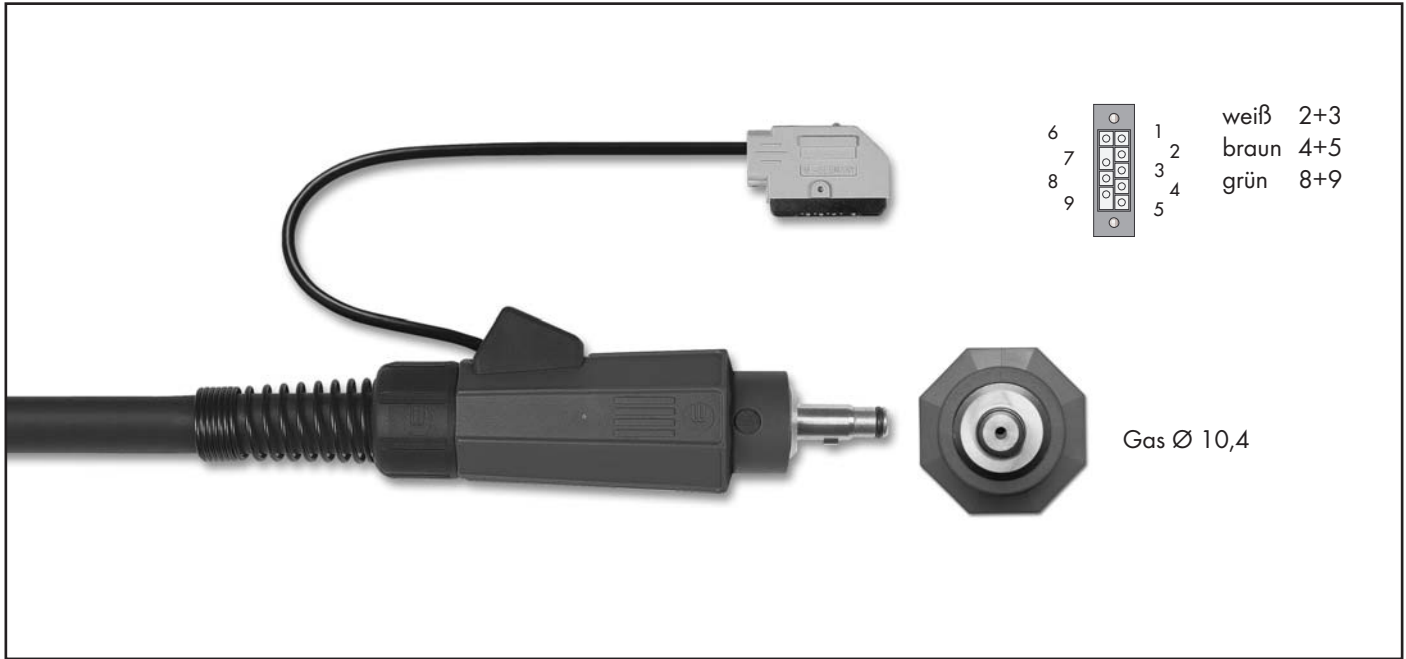

Brennertyp	Länge	Schalterfunktion	maschinenseitiger Anschluss	Schlauchpaketausführung	Bestellnummer
ABITIG® 9	4 m	DD	ZA Rechtecksteckverbinder 9-pol.	Standard	7S1SK043023615A00
	8 m	DD	ZA Rechtecksteckverbinder 9-pol.	Standard	7S1SK083023615A00
	4 m	DD	ZA Rechtecksteckverbinder 9-pol.	High Flex Leder	7S1SH043023615A00
	8 m	DD	ZA Rechtecksteckverbinder 9-pol.	High Flex Leder	7S1SH083023615A00

ABITIG® 9F	4 m	DD	ZA Rechtecksteckverbinder 9-pol.	Standard	7S1FK043023615A00
	8 m	DD	ZA Rechtecksteckverbinder 9-pol.	Standard	7S1FK083023615A00
	4 m	DD	ZA Rechtecksteckverbinder 9-pol.	High Flex Leder	7S1FH043023615A00
	8 m	DD	ZA Rechtecksteckverbinder 9-pol.	High Flex Leder	7S1FH083023615A00

ABITIG® 17	4 m	DD	ZA Rechtecksteckverbinder 9-pol.	Standard	7S2SK043023615A00
	8 m	DD	ZA Rechtecksteckverbinder 9-pol.	Standard	7S2SK083023615A00
	4 m	DD	ZA Rechtecksteckverbinder 9-pol.	High Flex Leder	7S2SH043023615A00
	8 m	DD	ZA Rechtecksteckverbinder 9-pol.	High Flex Leder	7S2SH083023615A00

ABITIG® 17F	4 m	DD	ZA Rechtecksteckverbinder 9-pol.	Standard	7S2FK043023615A00
	8 m	DD	ZA Rechtecksteckverbinder 9-pol.	Standard	7S2FK083023615A00
	4 m	DD	ZA Rechtecksteckverbinder 9-pol.	High Flex Leder	7S2FH043023615A00
	8 m	DD	ZA Rechtecksteckverbinder 9-pol.	High Flex Leder	7S2FH083023615A00

Technische Änderungen vorbehalten • Verkaufspreise = unverbindliche Preisempfehlung - Angebot freibleibend • © Copyright

ABITIG®-Brennerpreisliste

passend für WIG-Stromquellen des Fabrikates „fronius“

Brennertyp	Länge	Schalterfunktion	maschinenseitiger Anschluss	Schlauchpaketausführung	Bestellnummer
ABITIG® 26	4 m	DD	ZA Rechtecksteckverbinder 9-pol.	Standard	7S3SK043023615A00
	8 m	DD	ZA Rechtecksteckverbinder 9-pol.	Standard	7S3SK083023615A00
	4 m	DD	ZA Rechtecksteckverbinder 9-pol.	High Flex Leder	7S3SH043023615A00
	8 m	DD	ZA Rechtecksteckverbinder 9-pol.	High Flex Leder	7S3SH083023615A00
ABITIG® 26F	4 m	DD	ZA Rechtecksteckverbinder 9-pol.	Standard	7S3FK043023615A00
	8 m	DD	ZA Rechtecksteckverbinder 9-pol.	Standard	7S3FK083023615A00
	4 m	DD	ZA Rechtecksteckverbinder 9-pol.	High Flex Leder	7S3FH043023615A00
	8 m	DD	ZA Rechtecksteckverbinder 9-pol.	High Flex Leder	7S3FH083023615A00
ABITIG® 24G	4 m	DD	ZA Rechtecksteckverbinder 9-pol.	Standard	7S8SK043023615A00
	8 m	DD	ZA Rechtecksteckverbinder 9-pol.	Standard	7S8SK083023615A00
	4 m	DD	ZA Rechtecksteckverbinder 9-pol.	High Flex Leder	7S8SH043023615A00
	8 m	DD	ZA Rechtecksteckverbinder 9-pol.	High Flex Leder	7S8SH083023615A00
ABITIG® 200	4 m	DD	ZA Rechtecksteckverbinder 9-pol.	Standard	7T4SK043023615A00
	8 m	DD	ZA Rechtecksteckverbinder 9-pol.	Standard	7T4SK083023615A00
	4 m	DD	ZA Rechtecksteckverbinder 9-pol.	High Flex Leder	7T4SH043023615A00
	8 m	DD	ZA Rechtecksteckverbinder 9-pol.	High Flex Leder	7T4SH083023615A00
ABITIG® 200F	4 m	DD	ZA Rechtecksteckverbinder 9-pol.	Standard	7T4FK043023615A00
	8 m	DD	ZA Rechtecksteckverbinder 9-pol.	Standard	7T4FK083023615A00
	4 m	DD	ZA Rechtecksteckverbinder 9-pol.	High Flex Leder	7T4FH043023615A00
	8 m	DD	ZA Rechtecksteckverbinder 9-pol.	High Flex Leder	7T4FH083023615A00
ABITIG® 150	4 m	DD	ZA Rechtecksteckverbinder 9-pol.	Standard	7T6SK043023615A00
	8 m	DD	ZA Rechtecksteckverbinder 9-pol.	Standard	7T6SK083023615A00
	4 m	DD	ZA Rechtecksteckverbinder 9-pol.	High Flex Leder	7T6SH043023615A00
	8 m	DD	ZA Rechtecksteckverbinder 9-pol.	High Flex Leder	7T6SH083023615A00
ABITIG® 150F	4 m	DD	ZA Rechtecksteckverbinder 9-pol.	Standard	7T6FK043023615A00
	8 m	DD	ZA Rechtecksteckverbinder 9-pol.	Standard	7T6FK083023615A00
	4 m	DD	ZA Rechtecksteckverbinder 9-pol.	High Flex Leder	7T6FH043023615A00
	8 m	DD	ZA Rechtecksteckverbinder 9-pol.	High Flex Leder	7T6FH083023615A00

ABITIG®-Brennerpreisliste

passend für WIG-Stromquellen des Fabrikates „fronius“ Up/Down

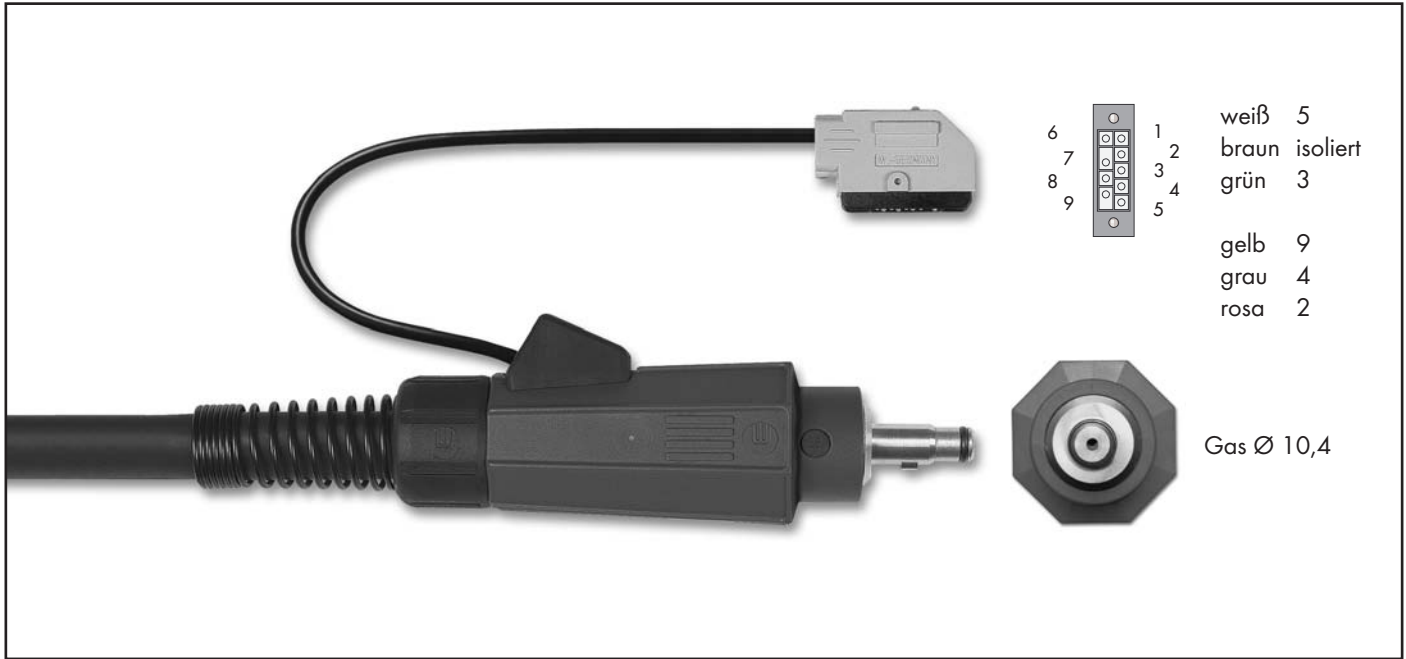

Brennertyp	Länge	Schalterfunktion	maschinenseitiger Anschluss	Schlauchpaketausführung	Bestellnummer
ABITIG® 9	4 m	UD	ZA Rechtecksteckverbinder 9-pol.	Standard	7S1SK046153616A00
	8 m	UD	ZA Rechtecksteckverbinder 9-pol.	Standard	7S1SK086153616A00
	4 m	UD	ZA Rechtecksteckverbinder 9-pol.	High Flex Leder	7S1SH046153616A00
	8 m	UD	ZA Rechtecksteckverbinder 9-pol.	High Flex Leder	7S1SH086153616A00

ABITIG® 9F	4 m	UD	ZA Rechtecksteckverbinder 9-pol.	Standard	7S1FK046153616A00
	8 m	UD	ZA Rechtecksteckverbinder 9-pol.	Standard	7S1FK086153616A00
	4 m	UD	ZA Rechtecksteckverbinder 9-pol.	High Flex Leder	7S1FH046153616A00
	8 m	UD	ZA Rechtecksteckverbinder 9-pol.	High Flex Leder	7S1FH086153616A00

ABITIG® 17	4 m	UD	ZA Rechtecksteckverbinder 9-pol.	Standard	7S2SK046153616A00
	8 m	UD	ZA Rechtecksteckverbinder 9-pol.	Standard	7S2SK086153616A00
	4 m	UD	ZA Rechtecksteckverbinder 9-pol.	High Flex Leder	7S2SH046153616A00
	8 m	UD	ZA Rechtecksteckverbinder 9-pol.	High Flex Leder	7S2SH086153616A00

ABITIG® 17F	4 m	UD	ZA Rechtecksteckverbinder 9-pol.	Standard	7S2FK046153616A00
	8 m	UD	ZA Rechtecksteckverbinder 9-pol.	Standard	7S2FK086153616A00
	4 m	UD	ZA Rechtecksteckverbinder 9-pol.	High Flex Leder	7S2FH046153616A00
	8 m	UD	ZA Rechtecksteckverbinder 9-pol.	High Flex Leder	7S2FH086153616A00

Technische Änderungen vorbehalten • Verkaufspreise = unverbindliche Preisempfehlung - Angebot freibleibend • © Copyright

ABITIG®-Brennerpreisliste

passend für WIG-Stromquellen des Fabrikates „fronius“ Up/Down

Brennertyp	Länge	Schalterfunktion	maschinenseitiger Anschluss	Schlauchpaketausführung	Bestellnummer
ABITIG® 26	4 m	UD	ZA Rechtecksteckverbinder 9-pol.	Standard	7S3SK046153616A00
	8 m	UD	ZA Rechtecksteckverbinder 9-pol.	Standard	7S3SK086153616A00
	4 m	UD	ZA Rechtecksteckverbinder 9-pol.	High Flex Leder	7S3SH046153616A00
	8 m	UD	ZA Rechtecksteckverbinder 9-pol.	High Flex Leder	7S3SH086153616A00
ABITIG® 26F	4 m	UD	ZA Rechtecksteckverbinder 9-pol.	Standard	7S3FK046153616A00
	8 m	UD	ZA Rechtecksteckverbinder 9-pol.	Standard	7S3FK086153616A00
	4 m	UD	ZA Rechtecksteckverbinder 9-pol.	High Flex Leder	7S3FH046153616A00
	8 m	UD	ZA Rechtecksteckverbinder 9-pol.	High Flex Leder	7S3FH086153616A00
ABITIG® 24G	4 m	UD	ZA Rechtecksteckverbinder 9-pol.	Standard	7S8SK046153616A00
	8 m	UD	ZA Rechtecksteckverbinder 9-pol.	Standard	7S8SK086153616A00
	4 m	UD	ZA Rechtecksteckverbinder 9-pol.	High Flex Leder	7S8SH046153616A00
	8 m	UD	ZA Rechtecksteckverbinder 9-pol.	High Flex Leder	7S8SH086153616A00
ABITIG® 200	4 m	UD	ZA Rechtecksteckverbinder 9-pol.	Standard	7T4SK046153616A00
	8 m	UD	ZA Rechtecksteckverbinder 9-pol.	Standard	7T4SK086153616A00
	4 m	UD	ZA Rechtecksteckverbinder 9-pol.	High Flex Leder	7T4SH046153616A00
	8 m	UD	ZA Rechtecksteckverbinder 9-pol.	High Flex Leder	7T4SH086153616A00
ABITIG® 200F	4 m	UD	ZA Rechtecksteckverbinder 9-pol.	Standard	7T4FK046153616A00
	8 m	UD	ZA Rechtecksteckverbinder 9-pol.	Standard	7T4FK086153616A00
	4 m	UD	ZA Rechtecksteckverbinder 9-pol.	High Flex Leder	7T4FH046153616A00
	8 m	UD	ZA Rechtecksteckverbinder 9-pol.	High Flex Leder	7T4FH086153616A00
ABITIG® 150	4 m	UD	ZA Rechtecksteckverbinder 9-pol.	Standard	7T6SK046153616A00
	8 m	UD	ZA Rechtecksteckverbinder 9-pol.	Standard	7T6SK086153616A00
	4 m	UD	ZA Rechtecksteckverbinder 9-pol.	High Flex Leder	7T6SH046153616A00
	8 m	UD	ZA Rechtecksteckverbinder 9-pol.	High Flex Leder	7T6SH086153616A00
ABITIG® 150F	4 m	UD	ZA Rechtecksteckverbinder 9-pol.	Standard	7T6FK046153616A00
	8 m	UD	ZA Rechtecksteckverbinder 9-pol.	Standard	7T6FK086153616A00
	4 m	UD	ZA Rechtecksteckverbinder 9-pol.	High Flex Leder	7T6FH046153616A00
	8 m	UD	ZA Rechtecksteckverbinder 9-pol.	High Flex Leder	7T6FH086153616A00

ABITIG®-Brennerpreisliste

passend für WIG-Stromquellen des Fabrikates „fronius“

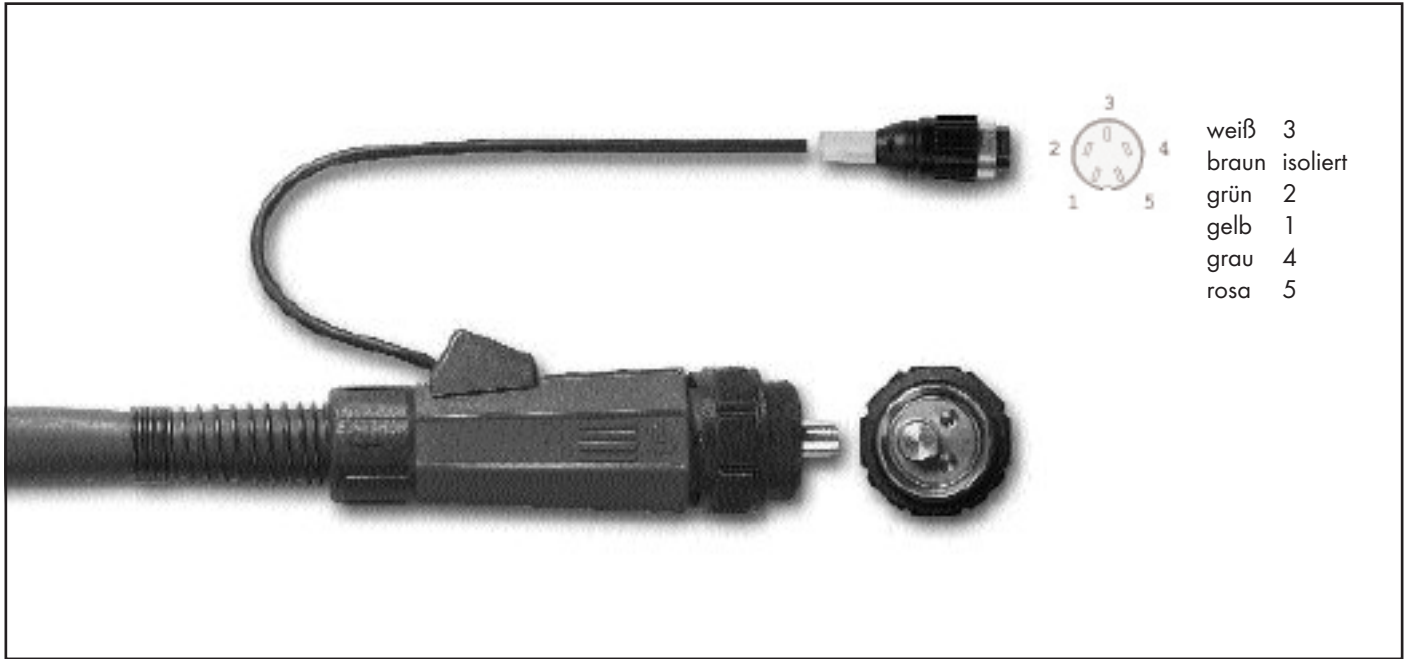

Brennertyp	Länge	Schalterfunktion	maschinenseitiger Anschluss	Schlauchpaketausführung	Bestellnummer
ABITIG® 9	4 m	UD	ZA - GZ Tuchel 5-pol.	Standard	7S1SK043150363B00
	8 m	UD	ZA - GZ Tuchel 5-pol.	Standard	7S1SK083150363B00
	4 m	UD	ZA - GZ Tuchel 5-pol.	High Flex Leder	7S1SH043150363B00
	8 m	UD	ZA - GZ Tuchel 5-pol.	High Flex Leder	7S1SH083150363B00

ABITIG® 9F	4 m	UD	ZA - GZ Tuchel 5-pol.	Standard	7S1FK043150363B00
	8 m	UD	ZA - GZ Tuchel 5-pol.	Standard	7S1FK083150363B00
	4 m	UD	ZA - GZ Tuchel 5-pol.	High Flex Leder	7S1FH043150363B00
	8 m	UD	ZA - GZ Tuchel 5-pol.	High Flex Leder	7S1FH083150363B00

ABITIG® 17	4 m	UD	ZA - GZ Tuchel 5-pol.	Standard	7S2SK043150363B00
	8 m	UD	ZA - GZ Tuchel 5-pol.	Standard	7S2SK083150363B00
	4 m	UD	ZA - GZ Tuchel 5-pol.	High Flex Leder	7S2SH043150363B00
	8 m	UD	ZA - GZ Tuchel 5-pol.	High Flex Leder	7S2SH083150363B00

ABITIG® 17F	4 m	UD	ZA - GZ Tuchel 5-pol.	Standard	7S2FK043150363B00
	8 m	UD	ZA - GZ Tuchel 5-pol.	Standard	7S2FK083150363B00
	4 m	UD	ZA - GZ Tuchel 5-pol.	High Flex Leder	7S2FH043150363B00
	8 m	UD	ZA - GZ Tuchel 5-pol.	High Flex Leder	7S2FH083150363B00

Technische Änderungen vorbehalten • Verkaufspreise = unverbindliche Preisempfehlung - Angebot freibleibend • © Copyright

ABITIG®-Brennerpreisliste

passend für WIG-Stromquellen des Fabrikates „fronius“

Brennertyp	Länge	Schalterfunktion	maschinenseitiger Anschluss	Schlauchpaketausführung	Bestellnummer
ABITIG® 26	4 m	UD	ZA - GZ Tuchel 5-pol.	Standard	7S3SK043150363B00
	8 m	UD	ZA - GZ Tuchel 5-pol.	Standard	7S3SK083150363B00
	4 m	UD	ZA - GZ Tuchel 5-pol.	High Flex Leder	7S3SH043150363B00
	8 m	UD	ZA - GZ Tuchel 5-pol.	High Flex Leder	7S3SH083150363B00
ABITIG® 26F	4 m	UD	ZA - GZ Tuchel 5-pol.	Standard	7S3FK043150363B00
	8 m	UD	ZA - GZ Tuchel 5-pol.	Standard	7S3FK083150363B00
	4 m	UD	ZA - GZ Tuchel 5-pol.	High Flex Leder	7S3FH043150363B00
	8 m	UD	ZA - GZ Tuchel 5-pol.	High Flex Leder	7S3FH083150363B00
ABITIG® 24G	4 m	UD	ZA - GZ Tuchel 5-pol.	Standard	7S8SK043150363B00
	8 m	UD	ZA - GZ Tuchel 5-pol.	Standard	7S8SK083150363B00
	4 m	UD	ZA - GZ Tuchel 5-pol.	High Flex Leder	7S8SH043150363B00
	8 m	UD	ZA - GZ Tuchel 5-pol.	High Flex Leder	7S8SH083150363B00
ABITIG® 200	4 m	UD	ZA - GZ Tuchel 5-pol.	Standard	7T4SK043150363B00
	8 m	UD	ZA - GZ Tuchel 5-pol.	Standard	7T4SK083150363B00
	4 m	UD	ZA - GZ Tuchel 5-pol.	High Flex Leder	7T4SH043150363B00
	8 m	UD	ZA - GZ Tuchel 5-pol.	High Flex Leder	7T4SH083150363B00
ABITIG® 200F	4 m	UD	ZA - GZ Tuchel 5-pol.	Standard	7T4FK043150363B00
	8 m	UD	ZA - GZ Tuchel 5-pol.	Standard	7T4FK083150363B00
	4 m	UD	ZA - GZ Tuchel 5-pol.	High Flex Leder	7T4FH043150363B00
	8 m	UD	ZA - GZ Tuchel 5-pol.	High Flex Leder	7T4FH083150363B00
ABITIG® 150	4 m	UD	ZA - GZ Tuchel 5-pol.	Standard	7T6SK043150363B00
	8 m	UD	ZA - GZ Tuchel 5-pol.	Standard	7T6SK083150363B00
	4 m	UD	ZA - GZ Tuchel 5-pol.	High Flex Leder	7T6SH043150363B00
	8 m	UD	ZA - GZ Tuchel 5-pol.	High Flex Leder	7T6SH083150363B00
ABITIG® 150F	4 m	UD	ZA - GZ Tuchel 5-pol.	Standard	7T6FK043150363B00
	8 m	UD	ZA - GZ Tuchel 5-pol.	Standard	7T6FK083150363B00
	4 m	UD	ZA - GZ Tuchel 5-pol.	High Flex Leder	7T6FH043150363B00
	8 m	UD	ZA - GZ Tuchel 5-pol.	High Flex Leder	7T6FH083150363B00

ABITIG®-Brennerpreisliste

passend für WIG-Stromquellen des Fabrikates „fronius“

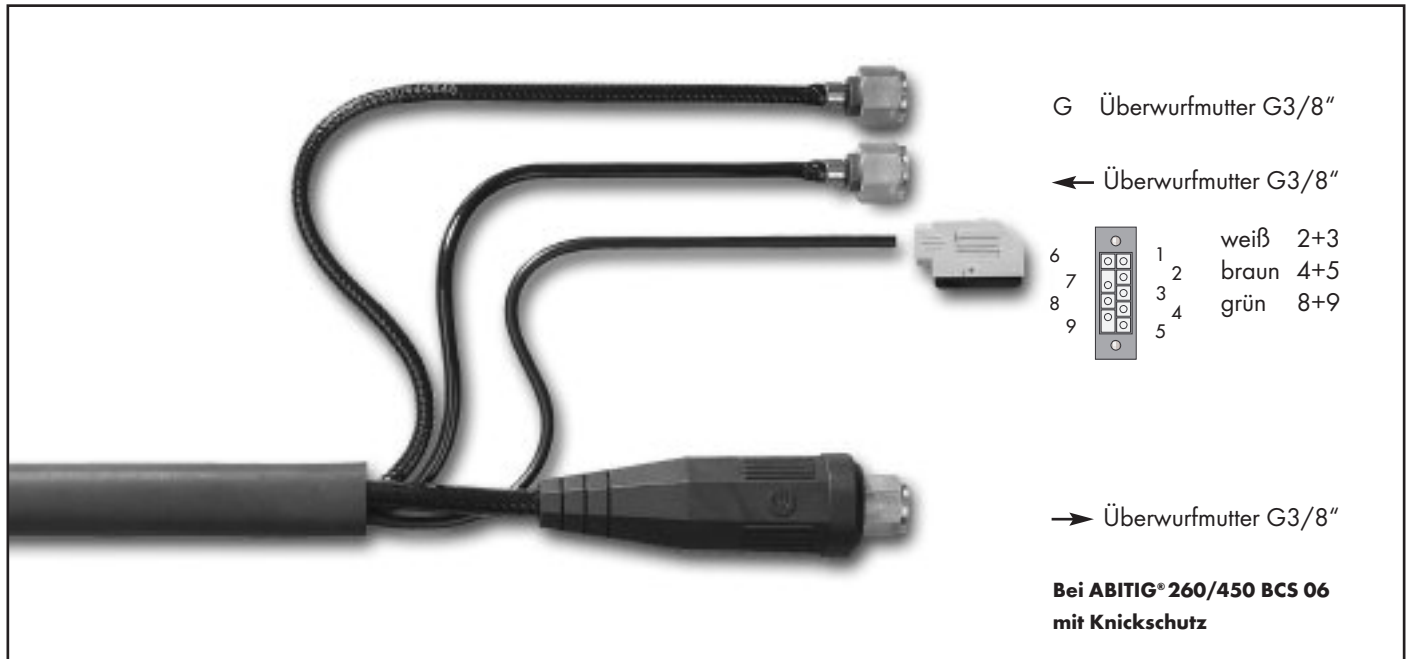

Brennertyp	Länge	Schalterfunktion	maschinenseitiger Anschluss	Schlauchpaketausführung	Bestellnummer
ABITIG® 18	4 m	DD	EA Rechtecksteckverbinder 9-pol.	Standard	7S4SK043020615A14
	8 m	DD	EA Rechtecksteckverbinder 9-pol.	Standard	7S4SK083020615A14
	4 m	DD	EA Rechtecksteckverbinder 9-pol.	High Flex Leder	7S4SH043020615A14
	8 m	DD	EA Rechtecksteckverbinder 9-pol.	High Flex Leder	7S4SH083020615A14

ABITIG® 18F	4 m	DD	EA Rechtecksteckverbinder 9-pol.	Standard	7S4FK043020615A14
	8 m	DD	EA Rechtecksteckverbinder 9-pol.	Standard	7S4FK083020615A14
	4 m	DD	EA Rechtecksteckverbinder 9-pol.	High Flex Leder	7S4FH043020615A14
	8 m	DD	EA Rechtecksteckverbinder 9-pol.	High Flex Leder	7S4FH083020615A14

ABITIG® 20	4 m	DD	EA Rechtecksteckverbinder 9-pol.	Standard	7S5SK043020615A14
	8 m	DD	EA Rechtecksteckverbinder 9-pol.	Standard	7S5SK083020615A14
	4 m	DD	EA Rechtecksteckverbinder 9-pol.	High Flex Leder	7S5SH043020615A14
	8 m	DD	EA Rechtecksteckverbinder 9-pol.	High Flex Leder	7S5SH083020615A14

ABITIG® 20F	4 m	DD	EA Rechtecksteckverbinder 9-pol.	Standard	7S5FK043020615A14
	8 m	DD	EA Rechtecksteckverbinder 9-pol.	Standard	7S5FK083020615A14
	4 m	DD	EA Rechtecksteckverbinder 9-pol.	High Flex Leder	7S5FH043020615A14
	8 m	DD	EA Rechtecksteckverbinder 9-pol.	High Flex Leder	7S5FH083020615A14

ABITIG®-Brennerpreisliste

passend für WIG-Stromquellen des Fabrikates „fronius“

Brennertyp	Länge	Schalterfunktion	maschinenseitiger Anschluss	Schlauchpaketausführung	Bestellnummer
ABITIG® 12-1	4 m	DD	EA Rechtecksteckverbinder 9-pol.	Standard	7S6SK043020615A14
	8 m	DD	EA Rechtecksteckverbinder 9-pol.	Standard	7S6SK083020615A14
	4 m	DD	EA Rechtecksteckverbinder 9-pol.	High Flex Leder	7S6SH043020615A14
	8 m	DD	EA Rechtecksteckverbinder 9-pol.	High Flex Leder	7S6SH083020615A14
ABITIG® 18SC	4 m	DD	EA Rechtecksteckverbinder 9-pol.	Standard	7S7SK043020615A14
	8 m	DD	EA Rechtecksteckverbinder 9-pol.	Standard	7S7SK083020615A14
	4 m	DD	EA Rechtecksteckverbinder 9-pol.	High Flex Leder	7S7SH043020615A14
	8 m	DD	EA Rechtecksteckverbinder 9-pol.	High Flex Leder	7S7SH083020615A14
ABITIG® 24W	4 m	DD	EA Rechtecksteckverbinder 9-pol.	Standard	7S9SK043020615A14
	8 m	DD	EA Rechtecksteckverbinder 9-pol.	Standard	7S9SK083020615A14
	4 m	DD	EA Rechtecksteckverbinder 9-pol.	High Flex Leder	7S9SH043020615A14
	8 m	DD	EA Rechtecksteckverbinder 9-pol.	High Flex Leder	7S9SH083020615A14
ABITIG® 450W	4 m	DD	EA Rechtecksteckverbinder 9-pol.	Standard	7T5SK043020615A14
	8 m	DD	EA Rechtecksteckverbinder 9-pol.	Standard	7T5SK083020615A14
	4 m	DD	EA Rechtecksteckverbinder 9-pol.	High Flex Leder	7T5SH043020615A14
	8 m	DD	EA Rechtecksteckverbinder 9-pol.	High Flex Leder	7T5SH083020615A14
ABITIG® 260W	4 m	DD	EA Rechtecksteckverbinder 9-pol.	Standard	7T7SK043020615A14
	8 m	DD	EA Rechtecksteckverbinder 9-pol.	Standard	7T7SK083020615A14
	4 m	DD	EA Rechtecksteckverbinder 9-pol.	High Flex Leder	7T7SH043020615A14
	8 m	DD	EA Rechtecksteckverbinder 9-pol.	High Flex Leder	7T7SH083020615A14
ABITIG® 450W SC	4 m	DD	EA Rechtecksteckverbinder 9-pol.	Standard	
	8 m	DD	EA Rechtecksteckverbinder 9-pol.	Standard	
	4 m	DD	EA Rechtecksteckverbinder 9-pol.	High Flex Leder	7T8SH043020615A14
	8 m	DD	EA Rechtecksteckverbinder 9-pol.	High Flex Leder	7T8SH083020615A14

ABITIG®-Brennerpreisliste

passend für WIG-Stromquellen des Fabrikates „fronius“

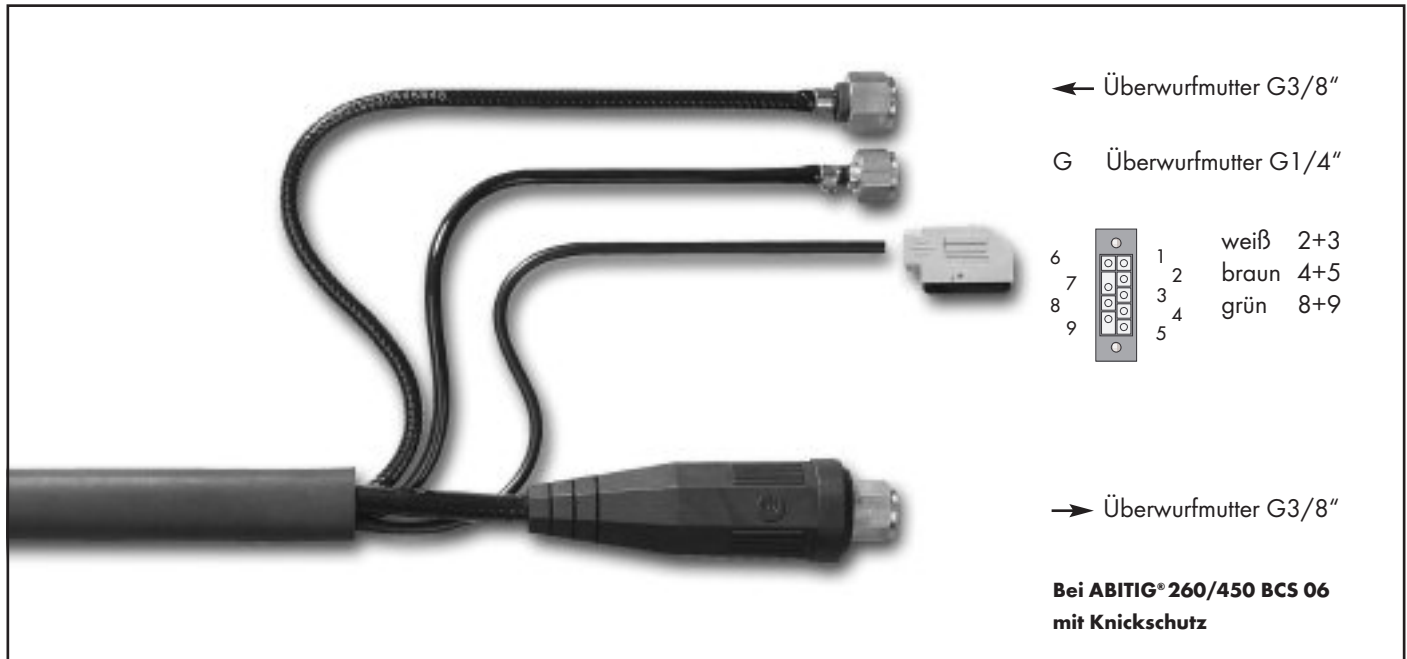

Brennertyp	Länge	Schalterfunktion	maschinenseitiger Anschluss	Schlauchpaketausführung	Bestellnummer
ABITIG® 18	4 m	DD	EA Rechtecksteckverbinder 9-pol.	Standard	7S4SK043020615A15
	8 m	DD	EA Rechtecksteckverbinder 9-pol.	Standard	7S4SK083020615A15
	4 m	DD	EA Rechtecksteckverbinder 9-pol.	High Flex Leder	7S4SH043020615A15
	8 m	DD	EA Rechtecksteckverbinder 9-pol.	High Flex Leder	7S4SH083020615A15

ABITIG® 18F	4 m	DD	EA Rechtecksteckverbinder 9-pol.	Standard	7S4FK043020615A15
	8 m	DD	EA Rechtecksteckverbinder 9-pol.	Standard	7S4FK083020615A15
	4 m	DD	EA Rechtecksteckverbinder 9-pol.	High Flex Leder	7S4FH043020615A15
	8 m	DD	EA Rechtecksteckverbinder 9-pol.	High Flex Leder	7S4FH083020615A15

ABITIG® 20	4 m	DD	EA Rechtecksteckverbinder 9-pol.	Standard	7S5SK043020615A15
	8 m	DD	EA Rechtecksteckverbinder 9-pol.	Standard	7S5SK083020615A15
	4 m	DD	EA Rechtecksteckverbinder 9-pol.	High Flex Leder	7S5SH043020615A15
	8 m	DD	EA Rechtecksteckverbinder 9-pol.	High Flex Leder	7S5SH083020615A15

ABITIG® 20F	4 m	DD	EA Rechtecksteckverbinder 9-pol.	Standard	7S5FK043020615A15
	8 m	DD	EA Rechtecksteckverbinder 9-pol.	Standard	7S5FK083020615A15
	4 m	DD	EA Rechtecksteckverbinder 9-pol.	High Flex Leder	7S5FH043020615A15
	8 m	DD	EA Rechtecksteckverbinder 9-pol.	High Flex Leder	7S5FH083020615A15

Technische Änderungen vorbehalten • Verkaufspreise = unverbindliche Preisempfehlung - Angebot freibleibend • © Copyright

ABITIG®-Brennerpreisliste

passend für WIG-Stromquellen des Fabrikates „fronius“

Brennertyp	Länge	Schalterfunktion	maschinenseitiger Anschluss	Schlauchpaketausführung	Bestellnummer
ABITIG® 12-1	4 m	DD	EA Rechtecksteckverbinder 9-pol.	Standard	7S6SK043020615A15
	8 m	DD	EA Rechtecksteckverbinder 9-pol.	Standard	7S6SK083020615A15
	4 m	DD	EA Rechtecksteckverbinder 9-pol.	High Flex Leder	7S6SH043020615A15
	8 m	DD	EA Rechtecksteckverbinder 9-pol.	High Flex Leder	7S6SH083020615A15
ABITIG® 18SC	4 m	DD	EA Rechtecksteckverbinder 9-pol.	Standard	7S7SK043020615A15
	8 m	DD	EA Rechtecksteckverbinder 9-pol.	Standard	7S7SK083020615A15
	4 m	DD	EA Rechtecksteckverbinder 9-pol.	High Flex Leder	7S7SH043020615A15
	8 m	DD	EA Rechtecksteckverbinder 9-pol.	High Flex Leder	7S7SH083020615A15
ABITIG® 24W	4 m	DD	EA Rechtecksteckverbinder 9-pol.	Standard	7S9SK043020615A15
	8 m	DD	EA Rechtecksteckverbinder 9-pol.	Standard	7S9SK083020615A15
	4 m	DD	EA Rechtecksteckverbinder 9-pol.	High Flex Leder	7S9SH043020615A15
	8 m	DD	EA Rechtecksteckverbinder 9-pol.	High Flex Leder	7S9SH083020615A15
ABITIG® 450W	4 m	DD	EA Rechtecksteckverbinder 9-pol.	Standard	7T5SK043020615A15
	8 m	DD	EA Rechtecksteckverbinder 9-pol.	Standard	7T5SK083020615A15
	4 m	DD	EA Rechtecksteckverbinder 9-pol.	High Flex Leder	7T5SH043020615A15
	8 m	DD	EA Rechtecksteckverbinder 9-pol.	High Flex Leder	7T5SH083020615A15
ABITIG® 260W	4 m	DD	EA Rechtecksteckverbinder 9-pol.	Standard	7T7SK043020615A15
	8 m	DD	EA Rechtecksteckverbinder 9-pol.	Standard	7T7SK083020615A15
	4 m	DD	EA Rechtecksteckverbinder 9-pol.	High Flex Leder	7T7SH043020615A15
	8 m	DD	EA Rechtecksteckverbinder 9-pol.	High Flex Leder	7T7SH083020615A15
ABITIG® 450W SC	4 m	DD	EA Rechtecksteckverbinder 9-pol.	Standard	
	8 m	DD	EA Rechtecksteckverbinder 9-pol.	Standard	
	4 m	DD	EA Rechtecksteckverbinder 9-pol.	High Flex Leder	7T8SH043020615A15
	8 m	DD	EA Rechtecksteckverbinder 9-pol.	High Flex Leder	7T8SH083020615A15

ABITIG®-Brennerpreisliste

passend für WIG-Stromquellen des Fabrikates „fronius“ Up/Down

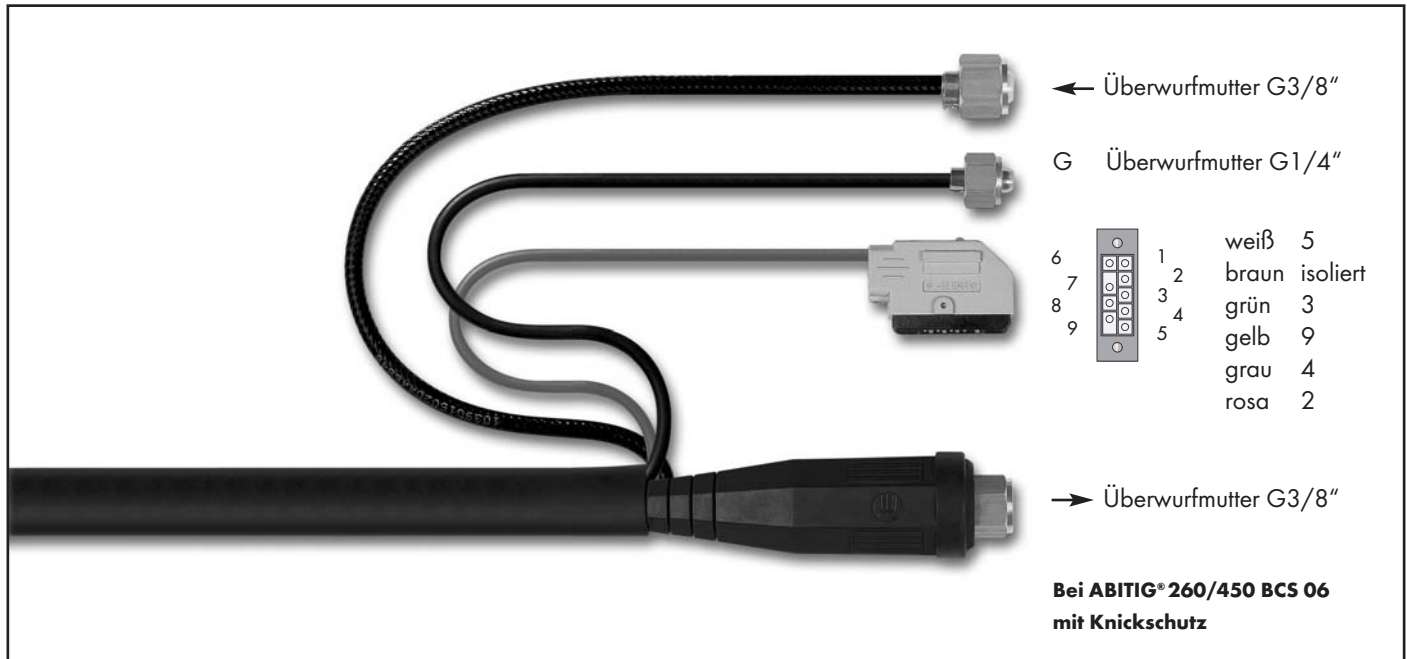

Brennertyp	Länge	Schalterfunktion	maschinenseitiger Anschluss	Schlauchpaketausführung	Bestellnummer
ABITIG® 18	4 m	UD	EA Rechtecksteckverbinder 9-pol.	Standard	7S4SK046150616A15
	8 m	UD	EA Rechtecksteckverbinder 9-pol.	Standard	7S4SK086150616A15
	4 m	UD	EA Rechtecksteckverbinder 9-pol.	High Flex Leder	7S4SH046150616A15
	8 m	UD	EA Rechtecksteckverbinder 9-pol.	High Flex Leder	7S4SH086150616A15
ABITIG® 18F	4 m	UD	EA Rechtecksteckverbinder 9-pol.	Standard	7S4FK046150616A15
	8 m	UD	EA Rechtecksteckverbinder 9-pol.	Standard	7S4FK086150616A15
	4 m	UD	EA Rechtecksteckverbinder 9-pol.	High Flex Leder	7S4FH046150616A15
	8 m	UD	EA Rechtecksteckverbinder 9-pol.	High Flex Leder	7S4FH086150616A15
ABITIG® 20	4 m	UD	EA Rechtecksteckverbinder 9-pol.	Standard	7S5SK046150616A15
	8 m	UD	EA Rechtecksteckverbinder 9-pol.	Standard	7S5SK086150616A15
	4 m	UD	EA Rechtecksteckverbinder 9-pol.	High Flex Leder	7S5SH046150616A15
	8 m	UD	EA Rechtecksteckverbinder 9-pol.	High Flex Leder	7S5SH086150616A15
ABITIG® 20F	4 m	UD	EA Rechtecksteckverbinder 9-pol.	Standard	7S5FK046150616A15
	8 m	UD	EA Rechtecksteckverbinder 9-pol.	Standard	7S5FK086150616A15
	4 m	UD	EA Rechtecksteckverbinder 9-pol.	High Flex Leder	7S5FH046150616A15
	8 m	UD	EA Rechtecksteckverbinder 9-pol.	High Flex Leder	7S5FH086150616A15

Technische Änderungen vorbehalten • Verkaufspreise = unverbindliche Preisempfehlung - Angebot freibleibend • © Copyright

ABITIG®-Brennerpreisliste

passend für WIG-Stromquellen des Fabrikates „fronius“ Up/Down

Brennertyp	Länge	Schalterfunktion	maschinenseitiger Anschluss	Schlauchpaketausführung	Bestellnummer
ABITIG® 12-1	4 m	UD	EA Rechtecksteckverbinder 9-pol.	Standard	7S6SK046150616A15
	8 m	UD	EA Rechtecksteckverbinder 9-pol.	Standard	7S6SK086150616A15
	4 m	UD	EA Rechtecksteckverbinder 9-pol.	High Flex Leder	7S6SH046150616A15
	8 m	UD	EA Rechtecksteckverbinder 9-pol.	High Flex Leder	7S6SH086150616A15
ABITIG® 18SC	4 m	UD	EA Rechtecksteckverbinder 9-pol.	Standard	7S7SK046150616A15
	8 m	UD	EA Rechtecksteckverbinder 9-pol.	Standard	7S7SK086150616A15
	4 m	UD	EA Rechtecksteckverbinder 9-pol.	High Flex Leder	7S7SH046150616A15
	8 m	UD	EA Rechtecksteckverbinder 9-pol.	High Flex Leder	7S7SH086150616A15
ABITIG® 24W	4 m	UD	EA Rechtecksteckverbinder 9-pol.	Standard	7S9SK046150616A15
	8 m	UD	EA Rechtecksteckverbinder 9-pol.	Standard	7S9SK086150616A15
	4 m	UD	EA Rechtecksteckverbinder 9-pol.	High Flex Leder	7S9SH046150616A15
	8 m	UD	EA Rechtecksteckverbinder 9-pol.	High Flex Leder	7S9SH086150616A15
ABITIG® 450W	4 m	UD	EA Rechtecksteckverbinder 9-pol.	Standard	7T5SK046150616A15
	8 m	UD	EA Rechtecksteckverbinder 9-pol.	Standard	7T5SK086150616A15
	4 m	UD	EA Rechtecksteckverbinder 9-pol.	High Flex Leder	7T5SH046150616A15
	8 m	UD	EA Rechtecksteckverbinder 9-pol.	High Flex Leder	7T5SH086150616A15
ABITIG® 260W	4 m	UD	EA Rechtecksteckverbinder 9-pol.	Standard	7T7SK046150616A15
	8 m	UD	EA Rechtecksteckverbinder 9-pol.	Standard	7T7SK086150616A15
	4 m	UD	EA Rechtecksteckverbinder 9-pol.	High Flex Leder	7T7SH046150616A15
	8 m	UD	EA Rechtecksteckverbinder 9-pol.	High Flex Leder	7T7SH086150616A15
ABITIG® 450W SC	4 m	UD	EA Rechtecksteckverbinder 9-pol.	Standard	
	8 m	UD	EA Rechtecksteckverbinder 9-pol.	Standard	
	4 m	UD	EA Rechtecksteckverbinder 9-pol.	High Flex Leder	7T8SH046150616A15
	8 m	UD	EA Rechtecksteckverbinder 9-pol.	High Flex Leder	7T8SH086150616A15

ABITIG®-Brennerpreisliste

passend für WIG-Stromquellen des Fabrikates „fronius“

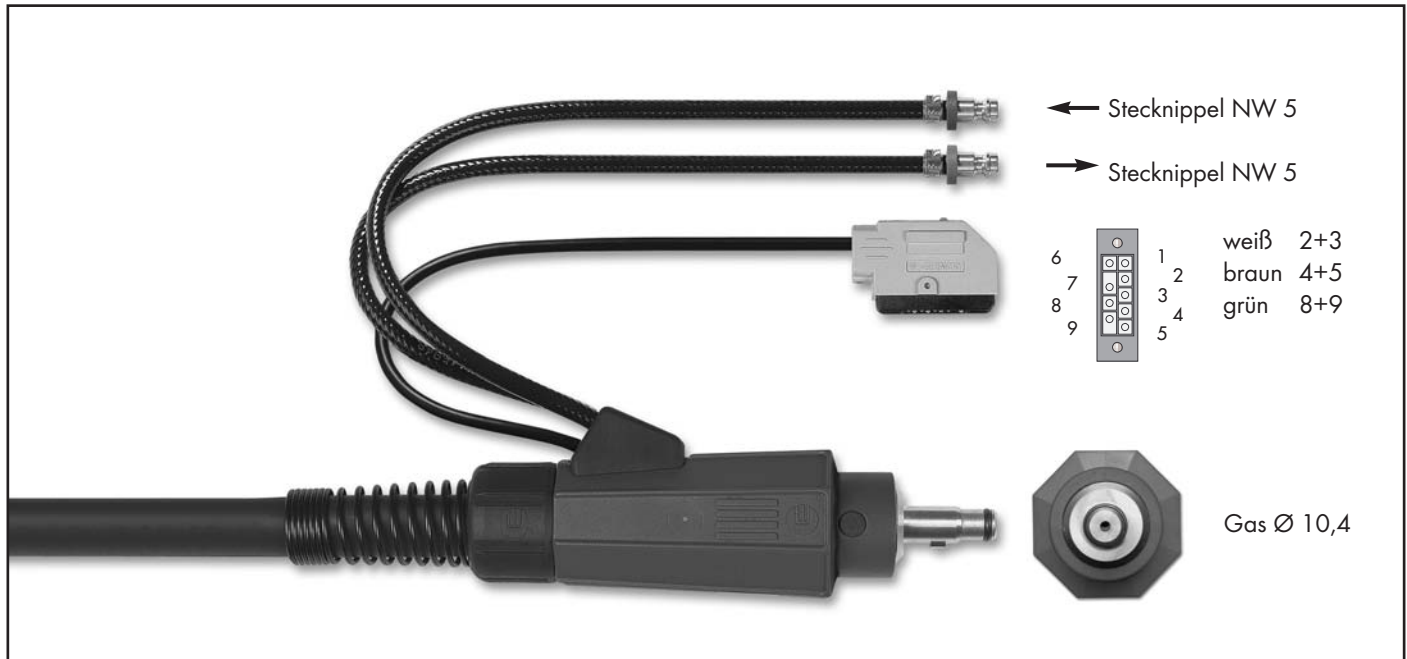

Brennertyp	Länge	Schalterfunktion	maschinenseitiger Anschluss	Schlauchpaketausführung	Bestellnummer
ABITIG® 18	4 m	DD	ZA Rechtecksteckverbinder 9-pol.	Standard	7S4SK043023615A12
	8 m	DD	ZA Rechtecksteckverbinder 9-pol.	Standard	7S4SK083023615A12
	4 m	DD	ZA Rechtecksteckverbinder 9-pol.	High Flex Leder	7S4SH043023615A12
	8 m	DD	ZA Rechtecksteckverbinder 9-pol.	High Flex Leder	7S4SH083023615A12
ABITIG® 18F	4 m	DD	ZA Rechtecksteckverbinder 9-pol.	Standard	7S4FK043023615A12
	8 m	DD	ZA Rechtecksteckverbinder 9-pol.	Standard	7S4FK083023615A12
	4 m	DD	ZA Rechtecksteckverbinder 9-pol.	High Flex Leder	7S4FH043023615A12
	8 m	DD	ZA Rechtecksteckverbinder 9-pol.	High Flex Leder	7S4FH083023615A12
ABITIG® 20	4 m	DD	ZA Rechtecksteckverbinder 9-pol.	Standard	7S5SK043023615A12
	8 m	DD	ZA Rechtecksteckverbinder 9-pol.	Standard	7S5SK083023615A12
	4 m	DD	ZA Rechtecksteckverbinder 9-pol.	High Flex Leder	7S5SH043023615A12
	8 m	DD	ZA Rechtecksteckverbinder 9-pol.	High Flex Leder	7S5SH083023615A12
ABITIG® 20F	4 m	DD	ZA Rechtecksteckverbinder 9-pol.	Standard	7S5FK043023615A12
	8 m	DD	ZA Rechtecksteckverbinder 9-pol.	Standard	7S5FK083023615A12
	4 m	DD	ZA Rechtecksteckverbinder 9-pol.	High Flex Leder	7S5FH043023615A12
	8 m	DD	ZA Rechtecksteckverbinder 9-pol.	High Flex Leder	7S5FH083023615A12

Technische Änderungen vorbehalten • Verkaufspreise = unverbindliche Preisempfehlung - Angebot freibleibend • © Copyright

ABITIG®-Brennerpreisliste

passend für WIG-Stromquellen des Fabrikates „fronius“

Brennertyp	Länge	Schalterfunktion	maschinenseitiger Anschluss	Schlauchpaketausführung	Bestellnummer
ABITIG® 12-1	4 m	DD	ZA Rechtecksteckverbinder 9-pol.	Standard	7S6SK043023615A12
	8 m	DD	ZA Rechtecksteckverbinder 9-pol.	Standard	7S6SK083023615A12
	4 m	DD	ZA Rechtecksteckverbinder 9-pol.	High Flex Leder	7S6SH043023615A12
	8 m	DD	ZA Rechtecksteckverbinder 9-pol.	High Flex Leder	7S6SH083023615A12
ABITIG® 18SC	4 m	DD	ZA Rechtecksteckverbinder 9-pol.	Standard	7S7SK043023615A12
	8 m	DD	ZA Rechtecksteckverbinder 9-pol.	Standard	7S7SK083023615A12
	4 m	DD	ZA Rechtecksteckverbinder 9-pol.	High Flex Leder	7S7SH043023615A12
	8 m	DD	ZA Rechtecksteckverbinder 9-pol.	High Flex Leder	7S7SH083023615A12
ABITIG® 24W	4 m	DD	ZA Rechtecksteckverbinder 9-pol.	Standard	7S9SK043023615A12
	8 m	DD	ZA Rechtecksteckverbinder 9-pol.	Standard	7S9SK083023615A12
	4 m	DD	ZA Rechtecksteckverbinder 9-pol.	High Flex Leder	7S9SH043023615A12
	8 m	DD	ZA Rechtecksteckverbinder 9-pol.	High Flex Leder	7S9SH083023615A12
ABITIG® 450W	4 m	DD	ZA Rechtecksteckverbinder 9-pol.	Standard	7T5SK043023615A12
	8 m	DD	ZA Rechtecksteckverbinder 9-pol.	Standard	7T5SK083023615A12
	4 m	DD	ZA Rechtecksteckverbinder 9-pol.	High Flex Leder	7T5SH043023615A12
	8 m	DD	ZA Rechtecksteckverbinder 9-pol.	High Flex Leder	7T5SH083023615A12
ABITIG® 260W	4 m	DD	ZA Rechtecksteckverbinder 9-pol.	Standard	7T7SK043023615A12
	8 m	DD	ZA Rechtecksteckverbinder 9-pol.	Standard	7T7SK083023615A12
	4 m	DD	ZA Rechtecksteckverbinder 9-pol.	High Flex Leder	7T7SH043023615A12
	8 m	DD	ZA Rechtecksteckverbinder 9-pol.	High Flex Leder	7T7SH083023615A12
ABITIG® 450W SC	4 m	DD	ZA Rechtecksteckverbinder 9-pol.	Standard	
	8 m	DD	ZA Rechtecksteckverbinder 9-pol.	Standard	
	4 m	DD	ZA Rechtecksteckverbinder 9-pol.	High Flex Leder	7T8SH043023615A12
	8 m	DD	ZA Rechtecksteckverbinder 9-pol.	High Flex Leder	7T8SH083023615A12

ABITIG®-Brennerpreisliste

passend für WIG-Stromquellen des Fabrikates „fronius“ Up/Down

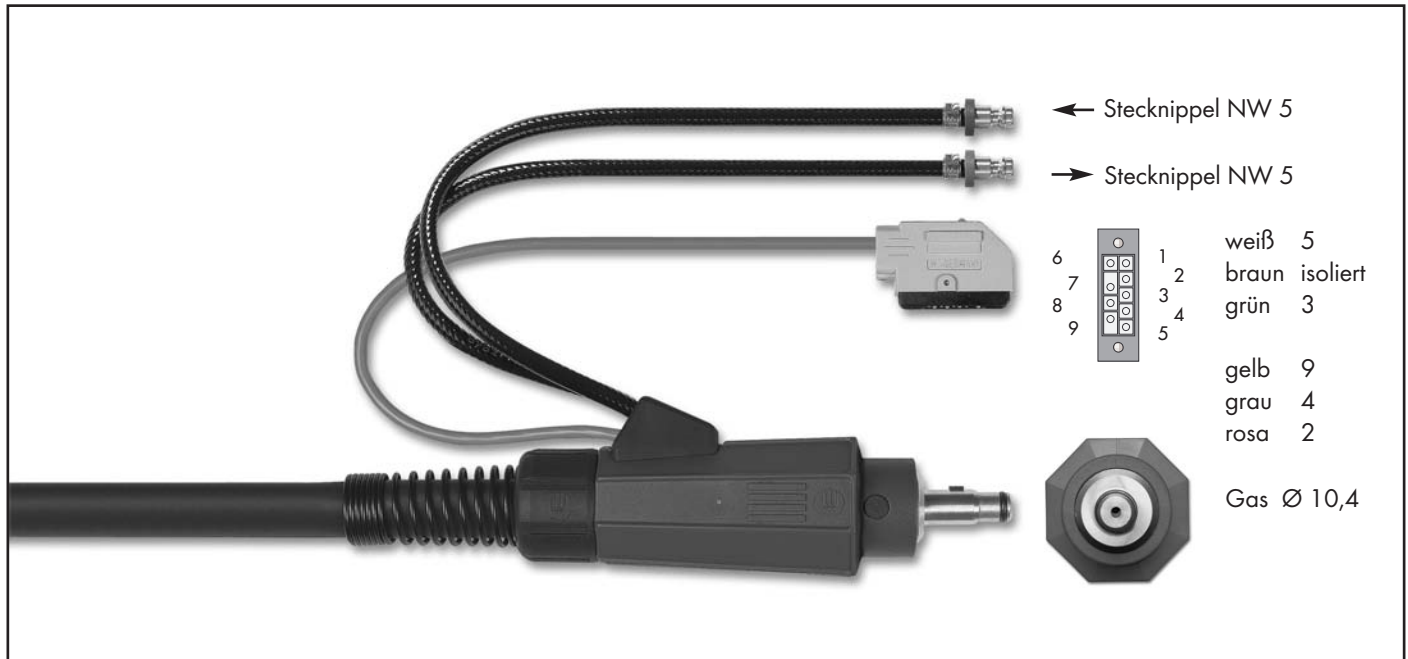

Brennertyp	Länge	Schalterfunktion	maschinenseitiger Anschluss	Schlauchpaketausführung	Bestellnummer
ABITIG® 18	4 m	UD	ZA Rechtecksteckverbinder 9-pol.	Standard	7S4SK046153616A12
	8 m	UD	ZA Rechtecksteckverbinder 9-pol.	Standard	7S4SK086153616A12
	4 m	UD	ZA Rechtecksteckverbinder 9-pol.	High Flex Leder	7S4SH046153616A12
	8 m	UD	ZA Rechtecksteckverbinder 9-pol.	High Flex Leder	7S4SH086153616A12
ABITIG® 18F	4 m	UD	ZA Rechtecksteckverbinder 9-pol.	Standard	7S4FK046153616A12
	8 m	UD	ZA Rechtecksteckverbinder 9-pol.	Standard	7S4FK086153616A12
	4 m	UD	ZA Rechtecksteckverbinder 9-pol.	High Flex Leder	7S4FH046153616A12
	8 m	UD	ZA Rechtecksteckverbinder 9-pol.	High Flex Leder	7S4FH086153616A12
ABITIG® 20	4 m	UD	ZA Rechtecksteckverbinder 9-pol.	Standard	7S5SK046153616A12
	8 m	UD	ZA Rechtecksteckverbinder 9-pol.	Standard	7S5SK086153616A12
	4 m	UD	ZA Rechtecksteckverbinder 9-pol.	High Flex Leder	7S5SH046153616A12
	8 m	UD	ZA Rechtecksteckverbinder 9-pol.	High Flex Leder	7S5SH086153616A12
ABITIG® 20F	4 m	UD	ZA Rechtecksteckverbinder 9-pol.	Standard	7S5FK046153616A12
	8 m	UD	ZA Rechtecksteckverbinder 9-pol.	Standard	7S5FK086153616A12
	4 m	UD	ZA Rechtecksteckverbinder 9-pol.	High Flex Leder	7S5FH046153616A12
	8 m	UD	ZA Rechtecksteckverbinder 9-pol.	High Flex Leder	7S5FH086153616A12

Technische Änderungen vorbehalten • Verkaufspreise = unverbindliche Preisempfehlung - Angebot freibleibend • © Copyright

ABITIG®-Brennerpreisliste

passend für WIG-Stromquellen des Fabrikates „fronius“ Up/Down

Brennertyp	Länge	Schalterfunktion	maschinenseitiger Anschluss	Schlauchpaketausführung	Bestellnummer
ABITIG® 12-1	4 m	UD	ZA Rechtecksteckverbinder 9-pol.	Standard	7S6SK046153616A12
	8 m	UD	ZA Rechtecksteckverbinder 9-pol.	Standard	7S6SK086153616A12
	4 m	UD	ZA Rechtecksteckverbinder 9-pol.	High Flex Leder	7S6SH046153616A12
	8 m	UD	ZA Rechtecksteckverbinder 9-pol.	High Flex Leder	7S6SH086153616A12
ABITIG® 18SC	4 m	UD	ZA Rechtecksteckverbinder 9-pol.	Standard	7S7SK046153616A12
	8 m	UD	ZA Rechtecksteckverbinder 9-pol.	Standard	7S7SK086153616A12
	4 m	UD	ZA Rechtecksteckverbinder 9-pol.	High Flex Leder	7S7SH046153616A12
	8 m	UD	ZA Rechtecksteckverbinder 9-pol.	High Flex Leder	7S7SH086153616A12
ABITIG® 24W	4 m	UD	ZA Rechtecksteckverbinder 9-pol.	Standard	7S9SK046153616A12
	8 m	UD	ZA Rechtecksteckverbinder 9-pol.	Standard	7S9SK086153616A12
	4 m	UD	ZA Rechtecksteckverbinder 9-pol.	High Flex Leder	7S9SH046153616A12
	8 m	UD	ZA Rechtecksteckverbinder 9-pol.	High Flex Leder	7S9SH086153616A12
ABITIG® 450W	4 m	UD	ZA Rechtecksteckverbinder 9-pol.	Standard	7T5SK046153616A12
	8 m	UD	ZA Rechtecksteckverbinder 9-pol.	Standard	7T5SK086153616A12
	4 m	UD	ZA Rechtecksteckverbinder 9-pol.	High Flex Leder	7T5SH046153616A12
	8 m	UD	ZA Rechtecksteckverbinder 9-pol.	High Flex Leder	7T5SH086153616A12
ABITIG® 260W	4 m	UD	ZA Rechtecksteckverbinder 9-pol.	Standard	7T7SK046153616A12
	8 m	UD	ZA Rechtecksteckverbinder 9-pol.	Standard	7T7SK086153616A12
	4 m	UD	ZA Rechtecksteckverbinder 9-pol.	High Flex Leder	7T7SH046153616A12
	8 m	UD	ZA Rechtecksteckverbinder 9-pol.	High Flex Leder	7T7SH086153616A12
ABITIG® 450W SC	4 m	UD	ZA Rechtecksteckverbinder 9-pol.	Standard	
	8 m	UD	ZA Rechtecksteckverbinder 9-pol.	Standard	
	4 m	UD	ZA Rechtecksteckverbinder 9-pol.	High Flex Leder	7T8SH046153616A12
	8 m	UD	ZA Rechtecksteckverbinder 9-pol.	High Flex Leder	7T8SH086153616A12

ABITIG®-Brennerpreisliste

passend für WIG-Stromquellen des Fabrikates „fronius“



Brennertyp	Länge	Schalterfunktion	maschinenseitiger Anschluss	Schlauchpaketausführung	Bestellnummer
ABITIG® 18	4 m	UD	ZA - WZ-0 Tuchel 5-pol.	Standard	7S4SK043150363B12
	8 m	UD	ZA - WZ-0 Tuchel 5-pol.	Standard	7S4SK083150363B12
	4 m	UD	ZA - WZ-0 Tuchel 5-pol.	High Flex Leder	7S4SH043150363B12
	8 m	UD	ZA - WZ-0 Tuchel 5-pol.	High Flex Leder	7S4SH083150363B12
ABITIG® 18F	4 m	UD	ZA - WZ-0 Tuchel 5-pol.	Standard	7S4FK043150363B12
	8 m	UD	ZA - WZ-0 Tuchel 5-pol.	Standard	7S4FK083150363B12
	4 m	UD	ZA - WZ-0 Tuchel 5-pol.	High Flex Leder	7S4FH043150363B12
	8 m	UD	ZA - WZ-0 Tuchel 5-pol.	High Flex Leder	7S4FH083150363B12
ABITIG® 20	4 m	UD	ZA - WZ-0 Tuchel 5-pol.	Standard	7S5SK043150363B12
	8 m	UD	ZA - WZ-0 Tuchel 5-pol.	Standard	7S5SK083150363B12
	4 m	UD	ZA - WZ-0 Tuchel 5-pol.	High Flex Leder	7S5SH043150363B12
	8 m	UD	ZA - WZ-0 Tuchel 5-pol.	High Flex Leder	7S5SH083150363B12
ABITIG® 20F	4 m	UD	ZA - WZ-0 Tuchel 5-pol.	Standard	7S5FK043150363B12
	8 m	UD	ZA - WZ-0 Tuchel 5-pol.	Standard	7S5FK083150363B12
	4 m	UD	ZA - WZ-0 Tuchel 5-pol.	High Flex Leder	7S5FH043150363B12
	8 m	UD	ZA - WZ-0 Tuchel 5-pol.	High Flex Leder	7S5FH083150363B12

Technische Änderungen vorbehalten • Verkaufspreise = unverbindliche Preisempfehlung - Angebot freibleibend • © Copyright

ABITIG®-Brennerpreisliste

passend für WIG-Stromquellen des Fabrikates „fronius“

Brennertyp	Länge	Schalterfunktion	maschinenseitiger Anschluss	Schlauchpaketausführung	Bestellnummer
ABITIG® 12-1	4 m	UD	ZA - WZ-0 Tuchel 5-pol.	Standard	7S6SK043150363B12
	8 m	UD	ZA - WZ-0 Tuchel 5-pol.	Standard	7S6SK083150363B12
	4 m	UD	ZA - WZ-0 Tuchel 5-pol.	High Flex Leder	7S6SH043150363B12
	8 m	UD	ZA - WZ-0 Tuchel 5-pol.	High Flex Leder	7S6SH083150363B12
<hr/>					
ABITIG® 18SC	4 m	UD	ZA - WZ-0 Tuchel 5-pol.	Standard	7S7SK043150363B12
	8 m	UD	ZA - WZ-0 Tuchel 5-pol.	Standard	7S7SK083150363B12
	4 m	UD	ZA - WZ-0 Tuchel 5-pol.	High Flex Leder	7S7SH043150363B12
	8 m	UD	ZA - WZ-0 Tuchel 5-pol.	High Flex Leder	7S7SH083150363B12
<hr/>					
ABITIG® 24W	4 m	UD	ZA - WZ-0 Tuchel 5-pol.	Standard	7S9SK043150363B12
	8 m	UD	ZA - WZ-0 Tuchel 5-pol.	Standard	7S9SK083150363B12
	4 m	UD	ZA - WZ-0 Tuchel 5-pol.	High Flex Leder	7S9SH043150363B12
	8 m	UD	ZA - WZ-0 Tuchel 5-pol.	High Flex Leder	7S9SH083150363B12
<hr/>					
ABITIG® 450W	4 m	UD	ZA - WZ-0 Tuchel 5-pol.	Standard	7T5SK043150363B12
	8 m	UD	ZA - WZ-0 Tuchel 5-pol.	Standard	7T5SK083150363B12
	4 m	UD	ZA - WZ-0 Tuchel 5-pol.	High Flex Leder	7T5SH043150363B12
	8 m	UD	ZA - WZ-0 Tuchel 5-pol.	High Flex Leder	7T5SH083150363B12
<hr/>					
ABITIG® 260W	4 m	UD	ZA - WZ-0 Tuchel 5-pol.	Standard	7T7SK043150363B12
	8 m	UD	ZA - WZ-0 Tuchel 5-pol.	Standard	7T7SK083150363B12
	4 m	UD	ZA - WZ-0 Tuchel 5-pol.	High Flex Leder	7T7SH043150363B12
	8 m	UD	ZA - WZ-0 Tuchel 5-pol.	High Flex Leder	7T7SH083150363B12
<hr/>					
ABITIG® 450W SC	4 m	UD	ZA - WZ-0 Tuchel 5-pol.	Standard	
	8 m	UD	ZA - WZ-0 Tuchel 5-pol.	Standard	
	4 m	UD	ZA - WZ-0 Tuchel 5-pol.	High Flex Leder	7T8SH043150363B12
	8 m	UD	ZA - WZ-0 Tuchel 5-pol.	High Flex Leder	7T8SH083150363B12

ABITIG®-Brennerpreisliste

passend für WIG-Stromquellen des Fabrikates „hermann“

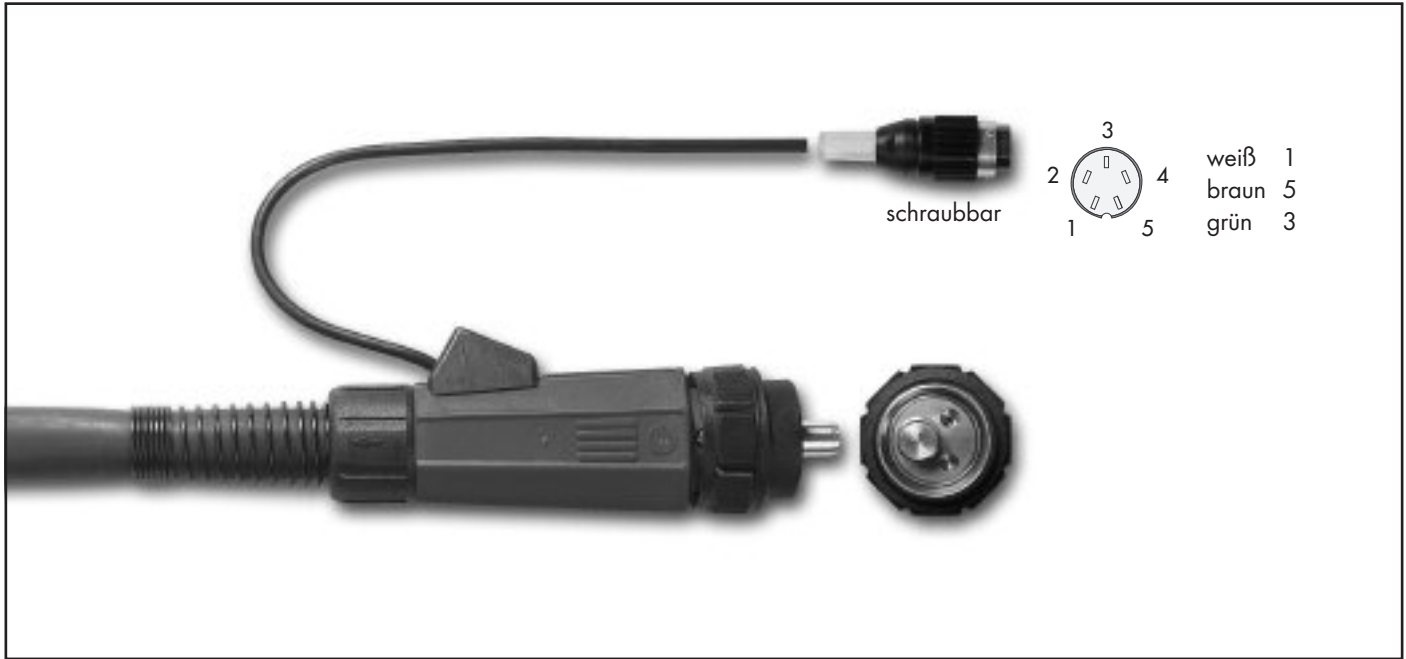

Brennertyp	Länge	Schalterfunktion	maschinenseitiger Anschluss	Schlauchpaketausführung	Bestellnummer
ABITIG® 9	4 m	DD	ZA - GZ Tuchel 5-pol. schraub.	Standard	7S1SK043020345A00
	8 m	DD	ZA - GZ Tuchel 5-pol. schraub.	Standard	7S1SK083020345A00
	4 m	DD	ZA - GZ Tuchel 5-pol. schraub.	High Flex Leder	7S1SH043020345A00
	8 m	DD	ZA - GZ Tuchel 5-pol. schraub.	High Flex Leder	7S1SH083020345A00
ABITIG® 9F	4 m	DD	ZA - GZ Tuchel 5-pol. schraub.	Standard	7S1FK043020345A00
	8 m	DD	ZA - GZ Tuchel 5-pol. schraub.	Standard	7S1FK083020345A00
	4 m	DD	ZA - GZ Tuchel 5-pol. schraub.	High Flex Leder	7S1FH043020345A00
	8 m	DD	ZA - GZ Tuchel 5-pol. schraub.	High Flex Leder	7S1FH083020345A00
ABITIG® 17	4 m	DD	ZA - GZ Tuchel 5-pol. schraub.	Standard	7S2SK043020345A00
	8 m	DD	ZA - GZ Tuchel 5-pol. schraub.	Standard	7S2SK083020345A00
	4 m	DD	ZA - GZ Tuchel 5-pol. schraub.	High Flex Leder	7S2SH043020345A00
	8 m	DD	ZA - GZ Tuchel 5-pol. schraub.	High Flex Leder	7S2SH083020345A00
ABITIG® 17F	4 m	DD	ZA - GZ Tuchel 5-pol. schraub.	Standard	7S2FK043020345A00
	8 m	DD	ZA - GZ Tuchel 5-pol. schraub.	Standard	7S2FK083020345A00
	4 m	DD	ZA - GZ Tuchel 5-pol. schraub.	High Flex Leder	7S2FH043020345A00
	8 m	DD	ZA - GZ Tuchel 5-pol. schraub.	High Flex Leder	7S2FH083020345A00

Technische Änderungen vorbehalten • Verkaufspreise = unverbindliche Preisempfehlung - Angebot freibleibend • © Copyright

ABITIG®-Brennerpreisliste

passend für WIG-Stromquellen des Fabrikates „hermann“

Brennertyp	Länge	Schalterfunktion	maschinenseitiger Anschluss	Schlauchpaketausführung	Bestellnummer
ABITIG® 26	4 m	DD	ZA - GZ Tuchel 5-pol. schraub.	Standard	7S3SK043020345A00
	8 m	DD	ZA - GZ Tuchel 5-pol. schraub.	Standard	7S3SK083020345A00
	4 m	DD	ZA - GZ Tuchel 5-pol. schraub.	High Flex Leder	7S3SH043020345A00
	8 m	DD	ZA - GZ Tuchel 5-pol. schraub.	High Flex Leder	7S3SH083020345A00

ABITIG® 26F	4 m	DD	ZA - GZ Tuchel 5-pol. schraub.	Standard	7S3FK043020345A00
	8 m	DD	ZA - GZ Tuchel 5-pol. schraub.	Standard	7S3FK083020345A00
	4 m	DD	ZA - GZ Tuchel 5-pol. schraub.	High Flex Leder	7S3FH043020345A00
	8 m	DD	ZA - GZ Tuchel 5-pol. schraub.	High Flex Leder	7S3FH083020345A00

ABITIG® 24G	4 m	DD	ZA - GZ Tuchel 5-pol. schraub.	Standard	7S8SK043020345A00
	8 m	DD	ZA - GZ Tuchel 5-pol. schraub.	Standard	7S8SK083020345A00
	4 m	DD	ZA - GZ Tuchel 5-pol. schraub.	High Flex Leder	7S8SH043020345A00
	8 m	DD	ZA - GZ Tuchel 5-pol. schraub.	High Flex Leder	7S8SH083020345A00

ABITIG® 200	4 m	DD	ZA - GZ Tuchel 5-pol. schraub.	Standard	7T4SK043020345A00
	8 m	DD	ZA - GZ Tuchel 5-pol. schraub.	Standard	7T4SK083020345A00
	4 m	DD	ZA - GZ Tuchel 5-pol. schraub.	High Flex Leder	7T4SH043020345A00
	8 m	DD	ZA - GZ Tuchel 5-pol. schraub.	High Flex Leder	7T4SH083020345A00

ABITIG® 200F	4 m	DD	ZA - GZ Tuchel 5-pol. schraub.	Standard	7T4FK043020345A00
	8 m	DD	ZA - GZ Tuchel 5-pol. schraub.	Standard	7T4FK083020345A00
	4 m	DD	ZA - GZ Tuchel 5-pol. schraub.	High Flex Leder	7T4FH043020345A00
	8 m	DD	ZA - GZ Tuchel 5-pol. schraub.	High Flex Leder	7T4FH083020345A00

ABITIG® 150	4 m	DD	ZA - GZ Tuchel 5-pol. schraub.	Standard	7T6SK043020345A00
	8 m	DD	ZA - GZ Tuchel 5-pol. schraub.	Standard	7T6SK083020345A00
	4 m	DD	ZA - GZ Tuchel 5-pol. schraub.	High Flex Leder	7T6SH043020345A00
	8 m	DD	ZA - GZ Tuchel 5-pol. schraub.	High Flex Leder	7T6SH083020345A00

ABITIG® 150F	4 m	DD	ZA - GZ Tuchel 5-pol. schraub.	Standard	7T6FK043020345A00
	8 m	DD	ZA - GZ Tuchel 5-pol. schraub.	Standard	7T6FK083020345A00
	4 m	DD	ZA - GZ Tuchel 5-pol. schraub.	High Flex Leder	7T6FH043020345A00
	8 m	DD	ZA - GZ Tuchel 5-pol. schraub.	High Flex Leder	7T6FH083020345A00

ABITIG®-Brennerpreisliste

passend für WIG-Stromquellen des Fabrikates „hermann“

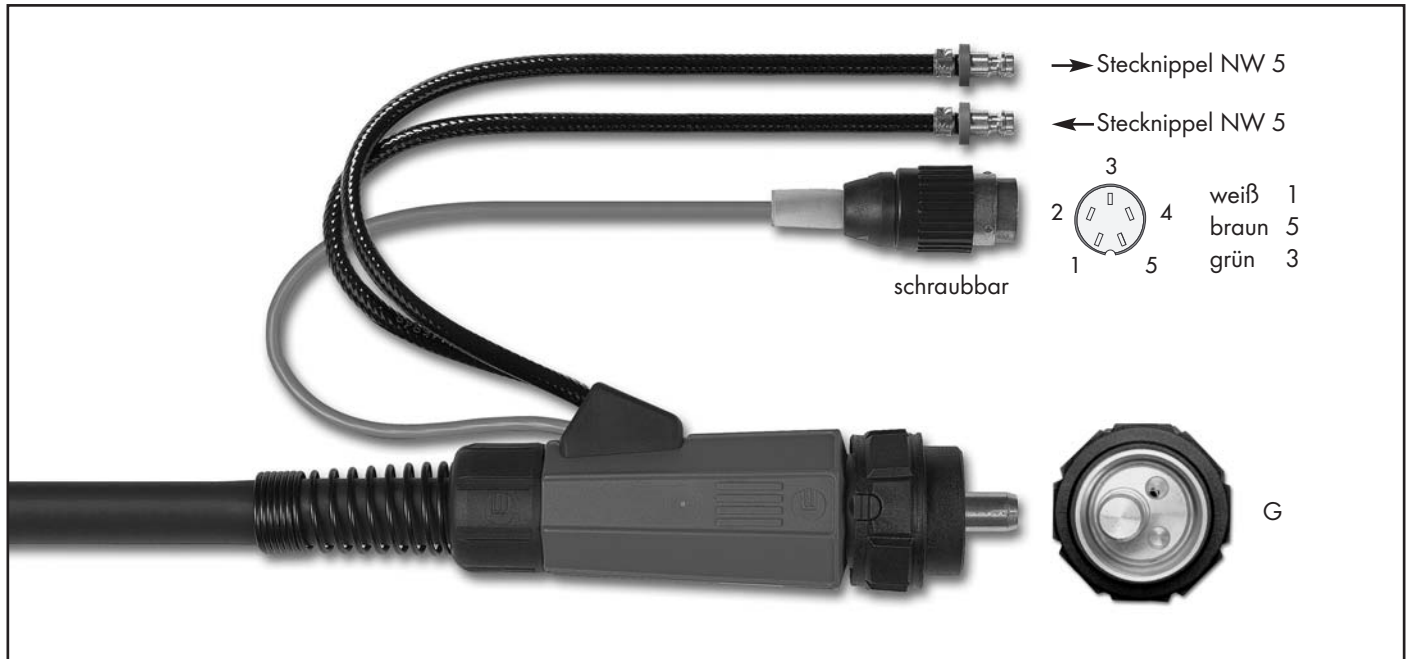

Brennertyp	Länge	Schalterfunktion	maschinenseitiger Anschluss	Schlauchpaketausführung	Bestellnummer
ABITIG® 18	4 m	DD	ZA - WZ-0 Tuchel 5-pol. schraub.	Standard	7S4SK043020345A12
	8 m	DD	ZA - WZ-0 Tuchel 5-pol. schraub.	Standard	7S4SK083020345A12
	4 m	DD	ZA - WZ-0 Tuchel 5-pol. schraub.	High Flex Leder	7S4SH043020345A12
	8 m	DD	ZA - WZ-0 Tuchel 5-pol. schraub.	High Flex Leder	7S4SH083020345A12

ABITIG® 18F	4 m	DD	ZA - WZ-0 Tuchel 5-pol. schraub.	Standard	7S4FK043020345A12
	8 m	DD	ZA - WZ-0 Tuchel 5-pol. schraub.	Standard	7S4FK083020345A12
	4 m	DD	ZA - WZ-0 Tuchel 5-pol. schraub.	High Flex Leder	7S4FH043020345A12
	8 m	DD	ZA - WZ-0 Tuchel 5-pol. schraub.	High Flex Leder	7S4FH083020345A12

ABITIG® 20	4 m	DD	ZA - WZ-0 Tuchel 5-pol. schraub.	Standard	7S5SK043020345A12
	8 m	DD	ZA - WZ-0 Tuchel 5-pol. schraub.	Standard	7S5SK083020345A12
	4 m	DD	ZA - WZ-0 Tuchel 5-pol. schraub.	High Flex Leder	7S5SH043020345A12
	8 m	DD	ZA - WZ-0 Tuchel 5-pol. schraub.	High Flex Leder	7S5SH083020345A12

ABITIG® 20F	4 m	DD	ZA - WZ-0 Tuchel 5-pol. schraub.	Standard	7S5FK043020345A12
	8 m	DD	ZA - WZ-0 Tuchel 5-pol. schraub.	Standard	7S5FK083020345A12
	4 m	DD	ZA - WZ-0 Tuchel 5-pol. schraub.	High Flex Leder	7S5FH043020345A12
	8 m	DD	ZA - WZ-0 Tuchel 5-pol. schraub.	High Flex Leder	7S5FH083020345A12

Technische Änderungen vorbehalten • Verkaufspreise = unverbindliche Preisempfehlung - Angebot freibleibend • © Copyright

ABITIG®-Brennerpreisliste

passend für WIG-Stromquellen des Fabrikates „hermann“

Brennertyp	Länge	Schalterfunktion	maschinenseitiger Anschluss	Schlauchpaketausführung	Bestellnummer
ABITIG® 12-1	4 m	DD	ZA - WZ-0 Tuchel 5-pol. schraub.	Standard	7S6SK043020345A12
	8 m	DD	ZA - WZ-0 Tuchel 5-pol. schraub.	Standard	7S6SK083020345A12
	4 m	DD	ZA - WZ-0 Tuchel 5-pol. schraub.	High Flex Leder	7S6SH043020345A12
	8 m	DD	ZA - WZ-0 Tuchel 5-pol. schraub.	High Flex Leder	7S6SH083020345A12
ABITIG® 18 SC	4 m	DD	ZA - WZ-0 Tuchel 5-pol. schraub.	Standard	7S7SK043020345A12
	8 m	DD	ZA - WZ-0 Tuchel 5-pol. schraub.	Standard	7S7SK083020345A12
	4 m	DD	ZA - WZ-0 Tuchel 5-pol. schraub.	High Flex Leder	7S7SH043020345A12
	8 m	DD	ZA - WZ-0 Tuchel 5-pol. schraub.	High Flex Leder	7S7SH083020345A12
ABITIG® 24W	4 m	DD	ZA - WZ-0 Tuchel 5-pol. schraub.	Standard	7S9SK043020345A12
	8 m	DD	ZA - WZ-0 Tuchel 5-pol. schraub.	Standard	7S9SK083020345A12
	4 m	DD	ZA - WZ-0 Tuchel 5-pol. schraub.	High Flex Leder	7S9SH043020345A12
	8 m	DD	ZA - WZ-0 Tuchel 5-pol. schraub.	High Flex Leder	7S9SH083020345A12
ABITIG® 450W	4 m	DD	ZA - WZ-0 Tuchel 5-pol. schraub.	Standard	7T5SK043020345A12
	8 m	DD	ZA - WZ-0 Tuchel 5-pol. schraub.	Standard	7T5SK083020345A12
	4 m	DD	ZA - WZ-0 Tuchel 5-pol. schraub.	High Flex Leder	7T5SH043020345A12
	8 m	DD	ZA - WZ-0 Tuchel 5-pol. schraub.	High Flex Leder	7T5SH083020345A12
ABITIG® 260W	4 m	DD	ZA - WZ-0 Tuchel 5-pol. schraub.	Standard	7T7SK043020345A12
	8 m	DD	ZA - WZ-0 Tuchel 5-pol. schraub.	Standard	7T7SK083020345A12
	4 m	DD	ZA - WZ-0 Tuchel 5-pol. schraub.	High Flex Leder	7T7SH043020345A12
	8 m	DD	ZA - WZ-0 Tuchel 5-pol. schraub.	High Flex Leder	7T7SH083020345A12
ABITIG® 450W SC	4 m	DD	ZA - WZ-0 Tuchel 5-pol. schraub.	Standard	
	8 m	DD	ZA - WZ-0 Tuchel 5-pol. schraub.	Standard	
	4 m	DD	ZA - WZ-0 Tuchel 5-pol. schraub.	High Flex Leder	7T8SH043020345A12
	8 m	DD	ZA - WZ-0 Tuchel 5-pol. schraub.	High Flex Leder	7T8SH083020345A12

ABITIG®-Brennerpreisliste

passend für WIG-Stromquellen des Fabrikates „jäckle“

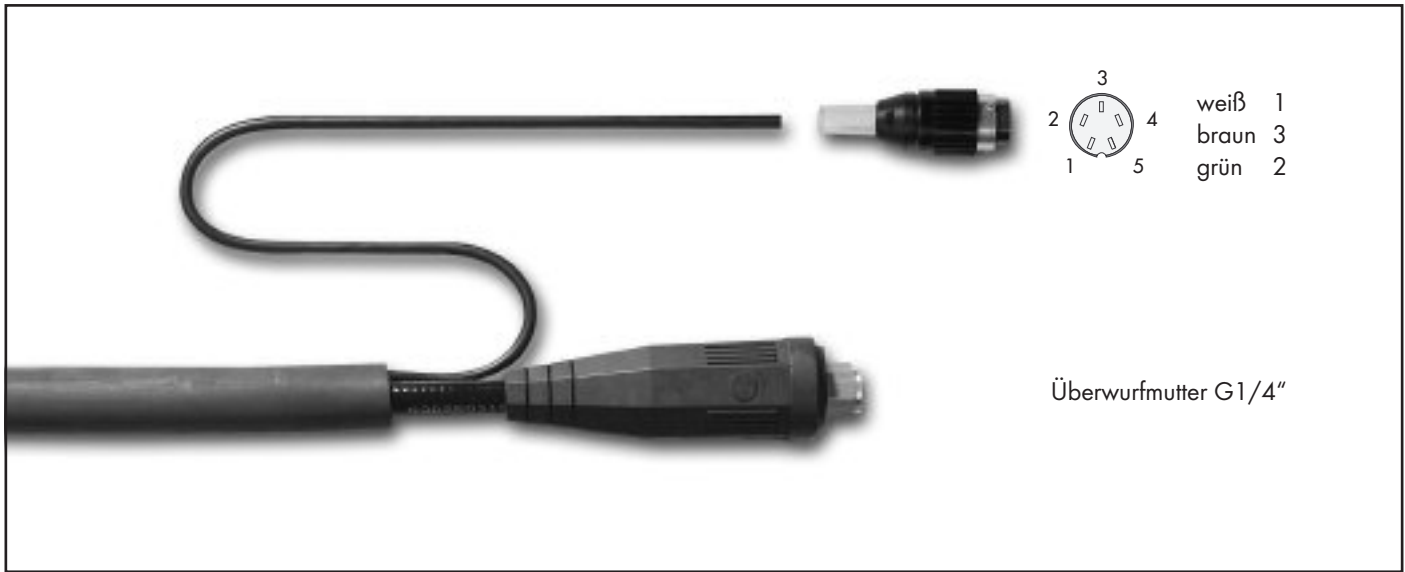

Brennertyp	Länge	Schalterfunktion	maschinenseitiger Anschluss	Schlauchpaketausführung	Bestellnummer
ABITIG® 9	4 m	DD	EA Tuchel 5-pol.	Standard	7S1SK043111101B00
	8 m	DD	EA Tuchel 5-pol.	Standard	7S1SK083111101B00
	4 m	DD	EA Tuchel 5-pol.	High Flex Leder	7S1SH043111101B00
	8 m	DD	EA Tuchel 5-pol.	High Flex Leder	7S1SH083111101B00
ABITIG® 9F	4 m	DD	EA Tuchel 5-pol.	Standard	7S1FK043111101B00
	8 m	DD	EA Tuchel 5-pol.	Standard	7S1FK083111101B00
	4 m	DD	EA Tuchel 5-pol.	High Flex Leder	7S1FH043111101B00
	8 m	DD	EA Tuchel 5-pol.	High Flex Leder	7S1FH083111101B00
ABITIG® 17	4 m	DD	EA Tuchel 5-pol.	Standard	7S2SK043111101B00
	8 m	DD	EA Tuchel 5-pol.	Standard	7S2SK083111101B00
	4 m	DD	EA Tuchel 5-pol.	High Flex Leder	7S2SH043111101B00
	8 m	DD	EA Tuchel 5-pol.	High Flex Leder	7S2SH083111101B00
ABITIG® 17F	4 m	DD	EA Tuchel 5-pol.	Standard	7S2FK043111101B00
	8 m	DD	EA Tuchel 5-pol.	Standard	7S2FK083111101B00
	4 m	DD	EA Tuchel 5-pol.	High Flex Leder	7S2FH043111101B00
	8 m	DD	EA Tuchel 5-pol.	High Flex Leder	7S2FH083111101B00

Technische Änderungen vorbehalten • Verkaufspreise = unverbindliche Preisempfehlung - Angebot freibleibend • © Copyright

ABITIG®-Brennerpreisliste

passend für WIG-Stromquellen des Fabrikates „jäckle“

Brennertyp	Länge	Schalterfunktion	maschinenseitiger Anschluss	Schlauchpaketausführung	Bestellnummer
ABITIG® 26	4 m	DD	EA Tuchel 5-pol.	Standard	7S3SK043111101B00
	8 m	DD	EA Tuchel 5-pol.	Standard	7S3SK083111101B00
	4 m	DD	EA Tuchel 5-pol.	High Flex Leder	7S3SH043111101B00
	8 m	DD	EA Tuchel 5-pol.	High Flex Leder	7S3SH083111101B00

ABITIG® 26F	4 m	DD	EA Tuchel 5-pol.	Standard	7S3FK043111101B00
	8 m	DD	EA Tuchel 5-pol.	Standard	7S3FK083111101B00
	4 m	DD	EA Tuchel 5-pol.	High Flex Leder	7S3FH043111101B00
	8 m	DD	EA Tuchel 5-pol.	High Flex Leder	7S3FH083111101B00

ABITIG® 24G	4 m	DD	EA Tuchel 5-pol.	Standard	7S8SK043111101B00
	8 m	DD	EA Tuchel 5-pol.	Standard	7S8SK083111101B00
	4 m	DD	EA Tuchel 5-pol.	High Flex Leder	7S8SH043111101B00
	8 m	DD	EA Tuchel 5-pol.	High Flex Leder	7S8SH083111101B00

ABITIG® 200	4 m	DD	EA Tuchel 5-pol.	Standard	7T4SK043111101B00
	8 m	DD	EA Tuchel 5-pol.	Standard	7T4SK083111101B00
	4 m	DD	EA Tuchel 5-pol.	High Flex Leder	7T4SH043111101B00
	8 m	DD	EA Tuchel 5-pol.	High Flex Leder	7T4SH083111101B00

ABITIG® 200F	4 m	DD	EA Tuchel 5-pol.	Standard	7T4FK043111101B00
	8 m	DD	EA Tuchel 5-pol.	Standard	7T4FK083111101B00
	4 m	DD	EA Tuchel 5-pol.	High Flex Leder	7T4FH043111101B00
	8 m	DD	EA Tuchel 5-pol.	High Flex Leder	7T4FH083111101B00

ABITIG® 150	4 m	DD	EA Tuchel 5-pol.	Standard	7T6SK043111101B00
	8 m	DD	EA Tuchel 5-pol.	Standard	7T6SK083111101B00
	4 m	DD	EA Tuchel 5-pol.	High Flex Leder	7T6SH043111101B00
	8 m	DD	EA Tuchel 5-pol.	High Flex Leder	7T6SH083111101B00

ABITIG® 150F	4 m	DD	EA Tuchel 5-pol.	Standard	7T6FK043111101B00
	8 m	DD	EA Tuchel 5-pol.	Standard	7T6FK083111101B00
	4 m	DD	EA Tuchel 5-pol.	High Flex Leder	7T6FH043111101B00
	8 m	DD	EA Tuchel 5-pol.	High Flex Leder	7T6FH083111101B00

ABITIG®-Brennerpreisliste

passend für WIG-Stromquellen des Fabrikates „jäckle“

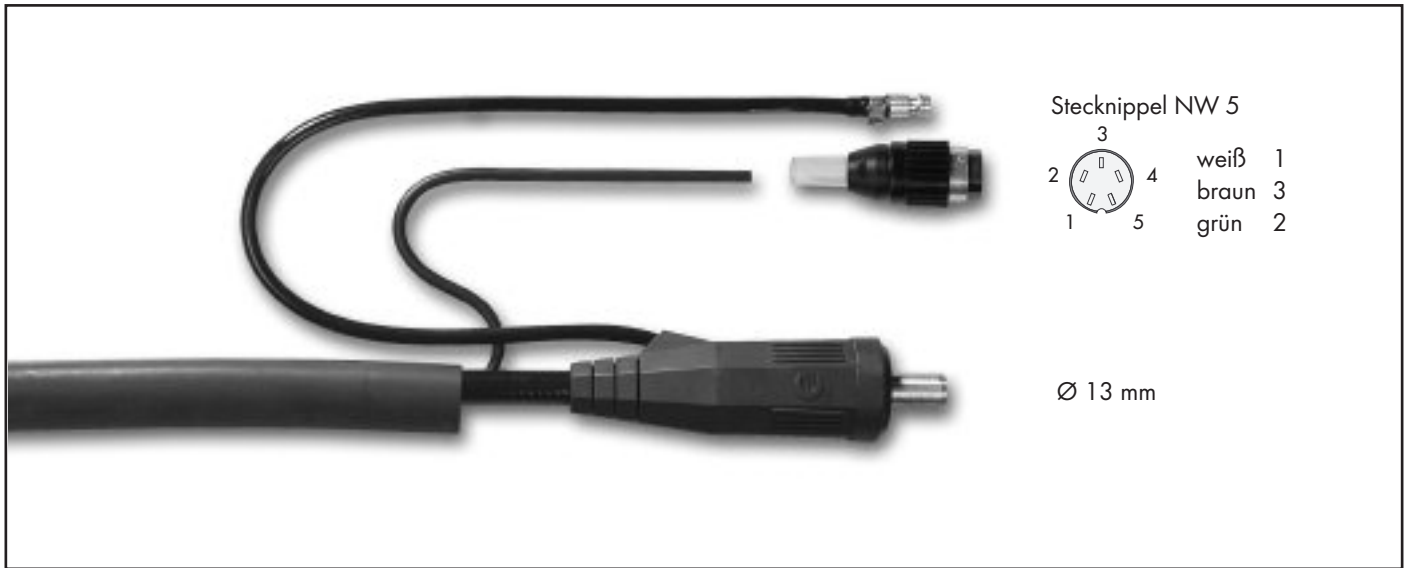

Brennertyp	Länge	Schalterfunktion	maschinenseitiger Anschluss	Schlauchpaketausführung	Bestellnummer
ABITIG® 9	4 m	DD	BSB 35-30 Tuchel 5-pol.	Standard	7S1SK043110001B06
	8 m	DD	BSB 35-30 Tuchel 5-pol.	Standard	7S1SK083110001B06
	4 m	DD	BSB 35-30 Tuchel 5-pol.	High Flex Leder	7S1SH043110001B06
	8 m	DD	BSB 35-30 Tuchel 5-pol.	High Flex Leder	7S1SH083110001B06

ABITIG® 9F	4 m	DD	BSB 35-30 Tuchel 5-pol.	Standard	7S1FK043110001B06
	8 m	DD	BSB 35-30 Tuchel 5-pol.	Standard	7S1FK083110001B06
	4 m	DD	BSB 35-30 Tuchel 5-pol.	High Flex Leder	7S1FH043110001B06
	8 m	DD	BSB 35-30 Tuchel 5-pol.	High Flex Leder	7S1FH083110001B06

ABITIG® 17	4 m	DD	BSB 35-30 Tuchel 5-pol.	Standard	7S2SK043110001B06
	8 m	DD	BSB 35-30 Tuchel 5-pol.	Standard	7S2SK083110001B06
	4 m	DD	BSB 35-30 Tuchel 5-pol.	High Flex Leder	7S2SH043110001B06
	8 m	DD	BSB 35-30 Tuchel 5-pol.	High Flex Leder	7S2SH083110001B06

ABITIG® 17F	4 m	DD	BSB 35-30 Tuchel 5-pol.	Standard	7S2FK043110001B06
	8 m	DD	BSB 35-30 Tuchel 5-pol.	Standard	7S2FK083110001B06
	4 m	DD	BSB 35-30 Tuchel 5-pol.	High Flex Leder	7S2FH043110001B06
	8 m	DD	BSB 35-30 Tuchel 5-pol.	High Flex Leder	7S2FH083110001B06

Technische Änderungen vorbehalten • Verkaufspreise = unverbindliche Preisempfehlung - Angebot freibleibend • © Copyright

ABITIG®-Brennerpreisliste

passend für WIG-Stromquellen des Fabrikates „jäckle“

Brennertyp	Länge	Schalterfunktion	maschinenseitiger Anschluss	Schlauchpaketausführung	Bestellnummer
ABITIG® 26	4 m	DD	BSB 35-50 Tuchel 5-pol.	Standard	7S3SK043110001B06
	8 m	DD	BSB 35-50 Tuchel 5-pol.	Standard	7S3SK083110001B06
	4 m	DD	BSB 35-50 Tuchel 5-pol.	High Flex Leder	7S3SH043110001B06
	8 m	DD	BSB 35-50 Tuchel 5-pol.	High Flex Leder	7S3SH083110001B06

ABITIG® 26F	4 m	DD	BSB 35-50 Tuchel 5-pol.	Standard	7S3FK043110001B06
	8 m	DD	BSB 35-50 Tuchel 5-pol.	Standard	7S3FK083110001B06
	4 m	DD	BSB 35-50 Tuchel 5-pol.	High Flex Leder	7S3FH043110001B06
	8 m	DD	BSB 35-50 Tuchel 5-pol.	High Flex Leder	7S3FH083110001B06

ABITIG® 24G	4 m	DD	BSB 35-50 Tuchel 5-pol.	Standard	7S8SK043110001B06
	8 m	DD	BSB 35-50 Tuchel 5-pol.	Standard	7S8SK083110001B06
	4 m	DD	BSB 35-50 Tuchel 5-pol.	High Flex Leder	7S8SH043110001B06
	8 m	DD	BSB 35-50 Tuchel 5-pol.	High Flex Leder	7S8SH083110001B06

ABITIG® 200	4 m	DD	BSB 35-50 Tuchel 5-pol.	Standard	7T4SK043110001B06
	8 m	DD	BSB 35-50 Tuchel 5-pol.	Standard	7T4SK083110001B06
	4 m	DD	BSB 35-50 Tuchel 5-pol.	High Flex Leder	7T4SH043110001B06
	8 m	DD	BSB 35-50 Tuchel 5-pol.	High Flex Leder	7T4SH083110001B06

ABITIG® 200F	4 m	DD	BSB 35-50 Tuchel 5-pol.	Standard	7T4FK043110001B06
	8 m	DD	BSB 35-50 Tuchel 5-pol.	Standard	7T4FK083110001B06
	4 m	DD	BSB 35-50 Tuchel 5-pol.	High Flex Leder	7T4FH043110001B06
	8 m	DD	BSB 35-50 Tuchel 5-pol.	High Flex Leder	7T4FH083110001B06

ABITIG® 150	4 m	DD	BSB 35-50 Tuchel 5-pol.	Standard	7T6SK043110001B06
	8 m	DD	BSB 35-50 Tuchel 5-pol.	Standard	7T6SK083110001B06
	4 m	DD	BSB 35-50 Tuchel 5-pol.	High Flex Leder	7T6SH043110001B06
	8 m	DD	BSB 35-50 Tuchel 5-pol.	High Flex Leder	7T6SH083110001B06

ABITIG® 150F	4 m	DD	BSB 35-50 Tuchel 5-pol.	Standard	7T6FK043110001B06
	8 m	DD	BSB 35-50 Tuchel 5-pol.	Standard	7T6FK083110001B06
	4 m	DD	BSB 35-50 Tuchel 5-pol.	High Flex Leder	7T6FH043110001B06
	8 m	DD	BSB 35-50 Tuchel 5-pol.	High Flex Leder	7T6FH083110001B06

ABITIG®-Brennerpreisliste

passend für WIG-Stromquellen des Fabrikates „jäckle“



Brennertyp	Länge	Schalterfunktion	maschinenseitiger Anschluss	Schlauchpaketausführung	Bestellnummer
ABITIG® 9	4 m	EDP	BSB 35-50 Tuchel 7-pol.	Standard	7S1SK046040027C06
	8 m	EDP	BSB 35-50 Tuchel 7-pol.	Standard	7S1SK086040027C06
	4 m	EDP	BSB 35-50 Tuchel 7-pol.	High Flex Leder	7S1SH046040027C06
	8 m	EDP	BSB 35-50 Tuchel 7-pol.	High Flex Leder	7S1SH086040027C06

ABITIG® 9F	4 m	EDP	BSB 35-50 Tuchel 7-pol.	Standard	7S1FK046040027C06
	8 m	EDP	BSB 35-50 Tuchel 7-pol.	Standard	7S1FK086040027C06
	4 m	EDP	BSB 35-50 Tuchel 7-pol.	High Flex Leder	7S1FH046040027C06
	8 m	EDP	BSB 35-50 Tuchel 7-pol.	High Flex Leder	7S1FH086040027C06

ABITIG® 17	4 m	EDP	BSB 35-50 Tuchel 7-pol.	Standard	7S2SK046040027C06
	8 m	EDP	BSB 35-50 Tuchel 7-pol.	Standard	7S2SK086040027C06
	4 m	EDP	BSB 35-50 Tuchel 7-pol.	High Flex Leder	7S2SH046040027C06
	8 m	EDP	BSB 35-50 Tuchel 7-pol.	High Flex Leder	7S2SH086040027C06

ABITIG® 17F	4 m	EDP	BSB 35-50 Tuchel 7-pol.	Standard	7S2FK046040027C06
	8 m	EDP	BSB 35-50 Tuchel 7-pol.	Standard	7S2FK086040027C06
	4 m	EDP	BSB 35-50 Tuchel 7-pol.	High Flex Leder	7S2FH046040027C06
	8 m	EDP	BSB 35-50 Tuchel 7-pol.	High Flex Leder	7S2FH086040027C06

Technische Änderungen vorbehalten • Verkaufspreise = unverbindliche Preisempfehlung - Angebot freibleibend • © Copyright

ABITIG®-Brennerpreisliste

passend für WIG-Stromquellen des Fabrikates „jäckle“

Brennertyp	Länge	Schalterfunktion	maschinenseitiger Anschluss	Schlauchpaketausführung	Bestellnummer
ABITIG® 26	4 m	EDP	BSB 35-50 Tuchel 7-pol.	Standard	7S3SK046040027C06
	8 m	EDP	BSB 35-50 Tuchel 7-pol.	Standard	7S3SK086040027C06
	4 m	EDP	BSB 35-50 Tuchel 7-pol.	High Flex Leder	7S3SH046040027C06
	8 m	EDP	BSB 35-50 Tuchel 7-pol.	High Flex Leder	7S3SH086040027C06
ABITIG® 26F	4 m	EDP	BSB 35-50 Tuchel 7-pol.	Standard	7S3FK046040027C06
	8 m	EDP	BSB 35-50 Tuchel 7-pol.	Standard	7S3FK086040027C06
	4 m	EDP	BSB 35-50 Tuchel 7-pol.	High Flex Leder	7S3FH046040027C06
	8 m	EDP	BSB 35-50 Tuchel 7-pol.	High Flex Leder	7S3FH086040027C06
ABITIG® 24G	4 m	EDP	BSB 35-50 Tuchel 7-pol.	Standard	7S8SK046040027C06
	8 m	EDP	BSB 35-50 Tuchel 7-pol.	Standard	7S8SK086040027C06
	4 m	EDP	BSB 35-50 Tuchel 7-pol.	High Flex Leder	7S8SH046040027C06
	8 m	EDP	BSB 35-50 Tuchel 7-pol.	High Flex Leder	7S8SH086040027C06
ABITIG® 200	4 m	EDP	BSB 35-50 Tuchel 7-pol.	Standard	7T4SK046040027C06
	8 m	EDP	BSB 35-50 Tuchel 7-pol.	Standard	7T4SK086040027C06
	4 m	EDP	BSB 35-50 Tuchel 7-pol.	High Flex Leder	7T4SH046040027C06
	8 m	EDP	BSB 35-50 Tuchel 7-pol.	High Flex Leder	7T4SH086040027C06
ABITIG® 200F	4 m	EDP	BSB 35-50 Tuchel 7-pol.	Standard	7T4FK046040027C06
	8 m	EDP	BSB 35-50 Tuchel 7-pol.	Standard	7T4FK086040027C06
	4 m	EDP	BSB 35-50 Tuchel 7-pol.	High Flex Leder	7T4FH046040027C06
	8 m	EDP	BSB 35-50 Tuchel 7-pol.	High Flex Leder	7T4FH086040027C06
ABITIG® 150	4 m	EDP	BSB 35-50 Tuchel 7-pol.	Standard	7T6SK046040027C06
	8 m	EDP	BSB 35-50 Tuchel 7-pol.	Standard	7T6SK086040027C06
	4 m	EDP	BSB 35-50 Tuchel 7-pol.	High Flex Leder	7T6SH046040027C06
	8 m	EDP	BSB 35-50 Tuchel 7-pol.	High Flex Leder	7T6SH086040027C06
ABITIG® 150F	4 m	EDP	BSB 35-50 Tuchel 7-pol.	Standard	7T6FK046040027C06
	8 m	EDP	BSB 35-50 Tuchel 7-pol.	Standard	7T6FK086040027C06
	4 m	EDP	BSB 35-50 Tuchel 7-pol.	High Flex Leder	7T6FH046040027C06
	8 m	EDP	BSB 35-50 Tuchel 7-pol.	High Flex Leder	7T6FH086040027C06

ABITIG®-Brennerpreisliste

passend für WIG-Stromquellen des Fabrikates „jäckle“



Brennertyp	Länge	Schalterfunktion	maschinenseitiger Anschluss	Schlauchpaketausführung	Bestellnummer
ABITIG® 9	4 m	DDP	BSB 35-50 Tuchel 7-pol.	Standard	7S1SK046040027D06
	8 m	DDP	BSB 35-50 Tuchel 7-pol.	Standard	7S1SK086040027D06
	4 m	DDP	BSB 35-50 Tuchel 7-pol.	High Flex Leder	7S1SH046040027D06
	8 m	DDP	BSB 35-50 Tuchel 7-pol.	High Flex Leder	7S1SH086040027D06
ABITIG® 9F	4 m	DDP	BSB 35-50 Tuchel 7-pol.	Standard	7S1FK046040027D06
	8 m	DDP	BSB 35-50 Tuchel 7-pol.	Standard	7S1FK086040027D06
	4 m	DDP	BSB 35-50 Tuchel 7-pol.	High Flex Leder	7S1FH046040027D06
	8 m	DDP	BSB 35-50 Tuchel 7-pol.	High Flex Leder	7S1FH086040027D06
ABITIG® 17	4 m	DDP	BSB 35-50 Tuchel 7-pol.	Standard	7S2SK046040027D06
	8 m	DDP	BSB 35-50 Tuchel 7-pol.	Standard	7S2SK086040027D06
	4 m	DDP	BSB 35-50 Tuchel 7-pol.	High Flex Leder	7S2SH046040027D06
	8 m	DDP	BSB 35-50 Tuchel 7-pol.	High Flex Leder	7S2SH086040027D06
ABITIG® 17F	4 m	DDP	BSB 35-50 Tuchel 7-pol.	Standard	7S2FK046040027D06
	8 m	DDP	BSB 35-50 Tuchel 7-pol.	Standard	7S2FK086040027D06
	4 m	DDP	BSB 35-50 Tuchel 7-pol.	High Flex Leder	7S2FH046040027D06
	8 m	DDP	BSB 35-50 Tuchel 7-pol.	High Flex Leder	7S2FH086040027D06

Technische Änderungen vorbehalten • Verkaufspreise = unverbindliche Preisempfehlung - Angebot freibleibend • © Copyright

ABITIG®-Brennerpreisliste

passend für WIG-Stromquellen des Fabrikates „jäckle“

Brennertyp	Länge	Schalterfunktion	maschinenseitiger Anschluss	Schlauchpaketausführung	Bestellnummer
ABITIG® 26	4 m	DDP	BSB 35-50 Tuchel 7-pol.	Standard	7S3SK046040027D06
	8 m	DDP	BSB 35-50 Tuchel 7-pol.	Standard	7S3SK086040027D06
	4 m	DDP	BSB 35-50 Tuchel 7-pol.	High Flex Leder	7S3SH046040027D06
	8 m	DDP	BSB 35-50 Tuchel 7-pol.	High Flex Leder	7S3SH086040027D06

ABITIG® 26F	4 m	DDP	BSB 35-50 Tuchel 7-pol.	Standard	7S3FK046040027D06
	8 m	DDP	BSB 35-50 Tuchel 7-pol.	Standard	7S3FK086040027D06
	4 m	DDP	BSB 35-50 Tuchel 7-pol.	High Flex Leder	7S3FH046040027D06
	8 m	DDP	BSB 35-50 Tuchel 7-pol.	High Flex Leder	7S3FH086040027D06

ABITIG® 24G	4 m	DDP	BSB 35-50 Tuchel 7-pol.	Standard	7S8SK046040027D06
	8 m	DDP	BSB 35-50 Tuchel 7-pol.	Standard	7S8SK086040027D06
	4 m	DDP	BSB 35-50 Tuchel 7-pol.	High Flex Leder	7S8SH046040027D06
	8 m	DDP	BSB 35-50 Tuchel 7-pol.	High Flex Leder	7S8SH086040027D06

ABITIG® 200	4 m	DDP	BSB 35-50 Tuchel 7-pol.	Standard	7T4SK046040027D06
	8 m	DDP	BSB 35-50 Tuchel 7-pol.	Standard	7T4SK086040027D06
	4 m	DDP	BSB 35-50 Tuchel 7-pol.	High Flex Leder	7T4SH046040027D06
	8 m	DDP	BSB 35-50 Tuchel 7-pol.	High Flex Leder	7T4SH086040027D06

ABITIG® 200F	4 m	DDP	BSB 35-50 Tuchel 7-pol.	Standard	7T4FK046040027D06
	8 m	DDP	BSB 35-50 Tuchel 7-pol.	Standard	7T4FK086040027D06
	4 m	DDP	BSB 35-50 Tuchel 7-pol.	High Flex Leder	7T4FH046040027D06
	8 m	DDP	BSB 35-50 Tuchel 7-pol.	High Flex Leder	7T4FH086040027D06

ABITIG® 150	4 m	DDP	BSB 35-50 Tuchel 7-pol.	Standard	7T6SK046040027D06
	8 m	DDP	BSB 35-50 Tuchel 7-pol.	Standard	7T6SK086040027D06
	4 m	DDP	BSB 35-50 Tuchel 7-pol.	High Flex Leder	7T6SH046040027D06
	8 m	DDP	BSB 35-50 Tuchel 7-pol.	High Flex Leder	7T6SH086040027D06

ABITIG® 150F	4 m	DDP	BSB 35-50 Tuchel 7-pol.	Standard	7T6FK046040027D06
	8 m	DDP	BSB 35-50 Tuchel 7-pol.	Standard	7T6FK086040027D06
	4 m	DDP	BSB 35-50 Tuchel 7-pol.	High Flex Leder	7T6FH046040027D06
	8 m	DDP	BSB 35-50 Tuchel 7-pol.	High Flex Leder	7T6FH086040027D06

ABITIG®-Brennerpreisliste

passend für WIG-Stromquellen des Fabrikates „jäckle“



→ Stecknippel NW 5

← Stecknippel NW 5

G Überwurfmutter G1/4"

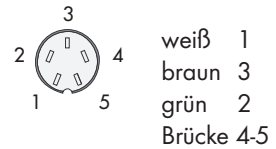

Ø 13 mm

Bei ABITIG® 260/450 BCS 01

Brennertyp	Länge	Schalterfunktion	maschinenseitiger Anschluss	Schlauchpaketausführung	Bestellnummer
ABITIG® 18	4 m	DD	BSB 35-50 Tuchel 5-pol.	Standard	7S4SK043110002B11
	8 m	DD	BSB 35-50 Tuchel 5-pol.	Standard	7S4SK083110002B11
	4 m	DD	BSB 35-50 Tuchel 5-pol.	High Flex Leder	7S4SH043110002B11
	8 m	DD	BSB 35-50 Tuchel 5-pol.	High Flex Leder	7S4SH083110002B11
ABITIG® 18F	4 m	DD	BSB 35-50 Tuchel 5-pol.	Standard	7S4FK043110002B11
	8 m	DD	BSB 35-50 Tuchel 5-pol.	Standard	7S4FK083110002B11
	4 m	DD	BSB 35-50 Tuchel 5-pol.	High Flex Leder	7S4FH043110002B11
	8 m	DD	BSB 35-50 Tuchel 5-pol.	High Flex Leder	7S4FH083110002B11
ABITIG® 20	4 m	DD	BSB 35-50 Tuchel 5-pol.	Standard	7S5SK043110002B11
	8 m	DD	BSB 35-50 Tuchel 5-pol.	Standard	7S5SK083110002B11
	4 m	DD	BSB 35-50 Tuchel 5-pol.	High Flex Leder	7S5SH043110002B11
	8 m	DD	BSB 35-50 Tuchel 5-pol.	High Flex Leder	7S5SH083110002B11
ABITIG® 20F	4 m	DD	BSB 35-50 Tuchel 5-pol.	Standard	7S5FK043110002B11
	8 m	DD	BSB 35-50 Tuchel 5-pol.	Standard	7S5FK083110002B11
	4 m	DD	BSB 35-50 Tuchel 5-pol.	High Flex Leder	7S5FH043110002B11
	8 m	DD	BSB 35-50 Tuchel 5-pol.	High Flex Leder	7S5FH083110002B11

Technische Änderungen vorbehalten • Verkaufspreise = unverbindliche Preisempfehlung - Angebot freibleibend • © Copyright

ABITIG®-Brennerpreisliste

passend für WIG-Stromquellen des Fabrikates „jäckle“

Brennertyp	Länge	Schalterfunktion	maschinenseitiger Anschluss	Schlauchpaketausführung	Bestellnummer
ABITIG® 12-1	4 m	DD	BSB 35-50 Tuchel 5-pol.	Standard	7S6SK043110002B11
	8 m	DD	BSB 35-50 Tuchel 5-pol.	Standard	7S6SK083110002B11
	4 m	DD	BSB 35-50 Tuchel 5-pol.	High Flex Leder	7S6SH043110002B11
	8 m	DD	BSB 35-50 Tuchel 5-pol.	High Flex Leder	7S6SH083110002B11

ABITIG® 18SC	4 m	DD	BSB 35-50 Tuchel 5-pol.	Standard	7S7SK043110002B11
	8 m	DD	BSB 35-50 Tuchel 5-pol.	Standard	7S7SK083110002B11
	4 m	DD	BSB 35-50 Tuchel 5-pol.	High Flex Leder	7S7SH043110002B11
	8 m	DD	BSB 35-50 Tuchel 5-pol.	High Flex Leder	7S7SH083110002B11

ABITIG® 24W	4 m	DD	BSB 35-50 Tuchel 5-pol.	Standard	7S9SK043110002B11
	8 m	DD	BSB 35-50 Tuchel 5-pol.	Standard	7S9SK083110002B11
	4 m	DD	BSB 35-50 Tuchel 5-pol.	High Flex Leder	7S9SH043110002B11
	8 m	DD	BSB 35-50 Tuchel 5-pol.	High Flex Leder	7S9SH083110002B11

ABITIG® 450W	4 m	DD	BSB 35-50 Tuchel 5-pol.	Standard	7T5SK043110102B11
	8 m	DD	BSB 35-50 Tuchel 5-pol.	Standard	7T5SK083110102B11
	4 m	DD	BSB 35-50 Tuchel 5-pol.	High Flex Leder	7T5SH043110102B11
	8 m	DD	BSB 35-50 Tuchel 5-pol.	High Flex Leder	7T5SH083110102B11

ABITIG® 260W	4 m	DD	BSB 35-50 Tuchel 5-pol.	Standard	7T7SK043110102B11
	8 m	DD	BSB 35-50 Tuchel 5-pol.	Standard	7T7SK083110102B11
	4 m	DD	BSB 35-50 Tuchel 5-pol.	High Flex Leder	7T7SH043110102B11
	8 m	DD	BSB 35-50 Tuchel 5-pol.	High Flex Leder	7T7SH083110102B11

ABITIG® 450W SC	4 m	DD	BSB 35-50 Tuchel 5-pol.	Standard	
	8 m	DD	BSB 35-50 Tuchel 5-pol.	Standard	
	4 m	DD	BSB 35-50 Tuchel 5-pol.	High Flex Leder	7T8SH043110102B11
	8 m	DD	BSB 35-50 Tuchel 5-pol.	High Flex Leder	7T8SH083110102B11

ABITIG®-Brennerpreisliste

passend für WIG-Stromquellen des Fabrikates „jäckle“



Brennertyp	Länge	Schalterfunktion	maschinenseitiger Anschluss	Schlauchpaketausführung	Bestellnummer
ABITIG® 18	4 m	EDP	BSB 35-50 Tuchel 7-pol.	Standard	7S4SK046040027C11
	8 m	EDP	BSB 35-50 Tuchel 7-pol.	Standard	7S4SK086040027C11
	4 m	EDP	BSB 35-50 Tuchel 7-pol.	High Flex Leder	7S4SH046040027C11
	8 m	EDP	BSB 35-50 Tuchel 7-pol.	High Flex Leder	7S4SH086040027C11
ABITIG® 18F	4 m	EDP	BSB 35-50 Tuchel 7-pol.	Standard	7S4FK046040027C11
	8 m	EDP	BSB 35-50 Tuchel 7-pol.	Standard	7S4FK086040027C11
	4 m	EDP	BSB 35-50 Tuchel 7-pol.	High Flex Leder	7S4FH046040027C11
	8 m	EDP	BSB 35-50 Tuchel 7-pol.	High Flex Leder	7S4FH086040027C11
ABITIG® 20	4 m	EDP	BSB 35-50 Tuchel 7-pol.	Standard	7S5SK046040027C11
	8 m	EDP	BSB 35-50 Tuchel 7-pol.	Standard	7S5SK086040027C11
	4 m	EDP	BSB 35-50 Tuchel 7-pol.	High Flex Leder	7S5SH046040027C11
	8 m	EDP	BSB 35-50 Tuchel 7-pol.	High Flex Leder	7S5SH086040027C11
ABITIG® 20F	4 m	EDP	BSB 35-50 Tuchel 7-pol.	Standard	7S5FK046040027C11
	8 m	EDP	BSB 35-50 Tuchel 7-pol.	Standard	7S5FK086040027C11
	4 m	EDP	BSB 35-50 Tuchel 7-pol.	High Flex Leder	7S5FH046040027C11
	8 m	EDP	BSB 35-50 Tuchel 7-pol.	High Flex Leder	7S5FH086040027C11

Technische Änderungen vorbehalten • Verkaufspreise = unverbindliche Preisempfehlung - Angebot freibleibend • © Copyright

ABITIG®-Brennerpreisliste

passend für WIG-Stromquellen des Fabrikates „jäckle“

Brennertyp	Länge	Schalterfunktion	maschinenseitiger Anschluss	Schlauchpaketausführung	Bestellnummer
ABITIG® 12-1	4 m	EDP	BSB 35-50 Tuchel 7-pol.	Standard	7S6SK046040027C11
	8 m	EDP	BSB 35-50 Tuchel 7-pol.	Standard	7S6SK086040027C11
	4 m	EDP	BSB 35-50 Tuchel 7-pol.	High Flex Leder	7S6SH046040027C11
	8 m	EDP	BSB 35-50 Tuchel 7-pol.	High Flex Leder	7S6SH086040027C11

ABITIG® 18SC	4 m	EDP	BSB 35-50 Tuchel 7-pol.	Standard	7S7SK046040027C11
	8 m	EDP	BSB 35-50 Tuchel 7-pol.	Standard	7S7SK086040027C11
	4 m	EDP	BSB 35-50 Tuchel 7-pol.	High Flex Leder	7S7SH046040027C11
	8 m	EDP	BSB 35-50 Tuchel 7-pol.	High Flex Leder	7S7SH086040027C11

ABITIG® 24W	4 m	EDP	BSB 35-50 Tuchel 7-pol.	Standard	7S9SK046040027C11
	8 m	EDP	BSB 35-50 Tuchel 7-pol.	Standard	7S9SK086040027C11
	4 m	EDP	BSB 35-50 Tuchel 7-pol.	High Flex Leder	7S9SH046040027C11
	8 m	EDP	BSB 35-50 Tuchel 7-pol.	High Flex Leder	7S9SH086040027C11

ABITIG® 450W	4 m	EDP	BSB 35-50 Tuchel 7-pol.	Standard	7T5SK046040127C11
	8 m	EDP	BSB 35-50 Tuchel 7-pol.	Standard	7T5SK086040127C11
	4 m	EDP	BSB 35-50 Tuchel 7-pol.	High Flex Leder	7T5SH046040127C11
	8 m	EDP	BSB 35-50 Tuchel 7-pol.	High Flex Leder	7T5SH086040127C11

ABITIG® 260W	4 m	EDP	BSB 35-50 Tuchel 7-pol.	Standard	7T7SK046040127C11
	8 m	EDP	BSB 35-50 Tuchel 7-pol.	Standard	7T7SK086040127C11
	4 m	EDP	BSB 35-50 Tuchel 7-pol.	High Flex Leder	7T7SH046040127C11
	8 m	EDP	BSB 35-50 Tuchel 7-pol.	High Flex Leder	7T7SH086040127C11

ABITIG® 450W SC	4 m	EDP	BSB 35-50 Tuchel 7-pol.	Standard	
	8 m	EDP	BSB 35-50 Tuchel 7-pol.	Standard	
	4 m	EDP	BSB 35-50 Tuchel 7-pol.	High Flex Leder	7T8SH046040127C11
	8 m	EDP	BSB 35-50 Tuchel 7-pol.	High Flex Leder	7T8SH086040127C11

ABITIG®-Brennerpreisliste

passend für WIG-Stromquellen des Fabrikates „jäckle“



Brennertyp	Länge	Schalterfunktion	maschinenseitiger Anschluss	Schlauchpaketausführung	Bestellnummer
ABITIG® 18	4 m	DDP	BSB 35-50 Tuchel 7-pol.	Standard	7S4SK046040027D11
	8 m	DDP	BSB 35-50 Tuchel 7-pol.	Standard	7S4SK086040027D11
	4 m	DDP	BSB 35-50 Tuchel 7-pol.	High Flex Leder	7S4SH046040027D11
	8 m	DDP	BSB 35-50 Tuchel 7-pol.	High Flex Leder	7S4SH086040027D11
ABITIG® 18F	4 m	DDP	BSB 35-50 Tuchel 7-pol.	Standard	7S4FK046040027D11
	8 m	DDP	BSB 35-50 Tuchel 7-pol.	Standard	7S4FK086040027D11
	4 m	DDP	BSB 35-50 Tuchel 7-pol.	High Flex Leder	7S4FH046040027D11
	8 m	DDP	BSB 35-50 Tuchel 7-pol.	High Flex Leder	7S4FH086040027D11
ABITIG® 20	4 m	DDP	BSB 35-50 Tuchel 7-pol.	Standard	7S5SK046040027D11
	8 m	DDP	BSB 35-50 Tuchel 7-pol.	Standard	7S5SK086040027D11
	4 m	DDP	BSB 35-50 Tuchel 7-pol.	High Flex Leder	7S5SH046040027D11
	8 m	DDP	BSB 35-50 Tuchel 7-pol.	High Flex Leder	7S5SH086040027D11
ABITIG® 20F	4 m	DDP	BSB 35-50 Tuchel 7-pol.	Standard	7S5FK046040027D11
	8 m	DDP	BSB 35-50 Tuchel 7-pol.	Standard	7S5FK086040027D11
	4 m	DDP	BSB 35-50 Tuchel 7-pol.	High Flex Leder	7S5FH046040027D11
	8 m	DDP	BSB 35-50 Tuchel 7-pol.	High Flex Leder	7S5FH086040027D11

Technische Änderungen vorbehalten • Verkaufspreise = unverbindliche Preisempfehlung - Angebot freibleibend • © Copyright

ABITIG®-Brennerpreisliste

passend für WIG-Stromquellen des Fabrikates „jäckle“

Brennertyp	Länge	Schalterfunktion	maschinenseitiger Anschluss	Schlauchpaketausführung	Bestellnummer
ABITIG® 12-1	4 m	DDP	BSB 35-50 Tuchel 7-pol.	Standard	7S6SK046040027D11
	8 m	DDP	BSB 35-50 Tuchel 7-pol.	Standard	7S6SK086040027D11
	4 m	DDP	BSB 35-50 Tuchel 7-pol.	High Flex Leder	7S6SH046040027D11
	8 m	DDP	BSB 35-50 Tuchel 7-pol.	High Flex Leder	7S6SH086040027D11
ABITIG® 18SC	4 m	DDP	BSB 35-50 Tuchel 7-pol.	Standard	7S7SK046040027D11
	8 m	DDP	BSB 35-50 Tuchel 7-pol.	Standard	7S7SK086040027D11
	4 m	DDP	BSB 35-50 Tuchel 7-pol.	High Flex Leder	7S7SH046040027D11
	8 m	DDP	BSB 35-50 Tuchel 7-pol.	High Flex Leder	7S7SH086040027D11
ABITIG® 24W	4 m	DDP	BSB 35-50 Tuchel 7-pol.	Standard	7S9SK046040027D11
	8 m	DDP	BSB 35-50 Tuchel 7-pol.	Standard	7S9SK086040027D11
	4 m	DDP	BSB 35-50 Tuchel 7-pol.	High Flex Leder	7S9SH046040027D11
	8 m	DDP	BSB 35-50 Tuchel 7-pol.	High Flex Leder	7S9SH086040027D11
ABITIG® 450W	4 m	DDP	BSB 35-50 Tuchel 7-pol.	Standard	7T5SK046040127D11
	8 m	DDP	BSB 35-50 Tuchel 7-pol.	Standard	7T5SK086040127D11
	4 m	DDP	BSB 35-50 Tuchel 7-pol.	High Flex Leder	7T5SH046040127D11
	8 m	DDP	BSB 35-50 Tuchel 7-pol.	High Flex Leder	7T5SH086040127D11
ABITIG® 260W	4 m	DDP	BSB 35-50 Tuchel 7-pol.	Standard	7T7SK046040127D11
	8 m	DDP	BSB 35-50 Tuchel 7-pol.	Standard	7T7SK086040127D11
	4 m	DDP	BSB 35-50 Tuchel 7-pol.	High Flex Leder	7T7SH046040127D11
	8 m	DDP	BSB 35-50 Tuchel 7-pol.	High Flex Leder	7T7SH086040127D11
ABITIG® 450W SC	4 m	DDP	BSB 35-50 Tuchel 7-pol.	Standard	
	8 m	DDP	BSB 35-50 Tuchel 7-pol.	Standard	
	4 m	DDP	BSB 35-50 Tuchel 7-pol.	High Flex Leder	7T8SH046040127D11
	8 m	DDP	BSB 35-50 Tuchel 7-pol.	High Flex Leder	7T8SH086040127D11

ABITIG®-Brennerpreisliste

passend für WIG-Stromquellen des Fabrikates „kemppi“

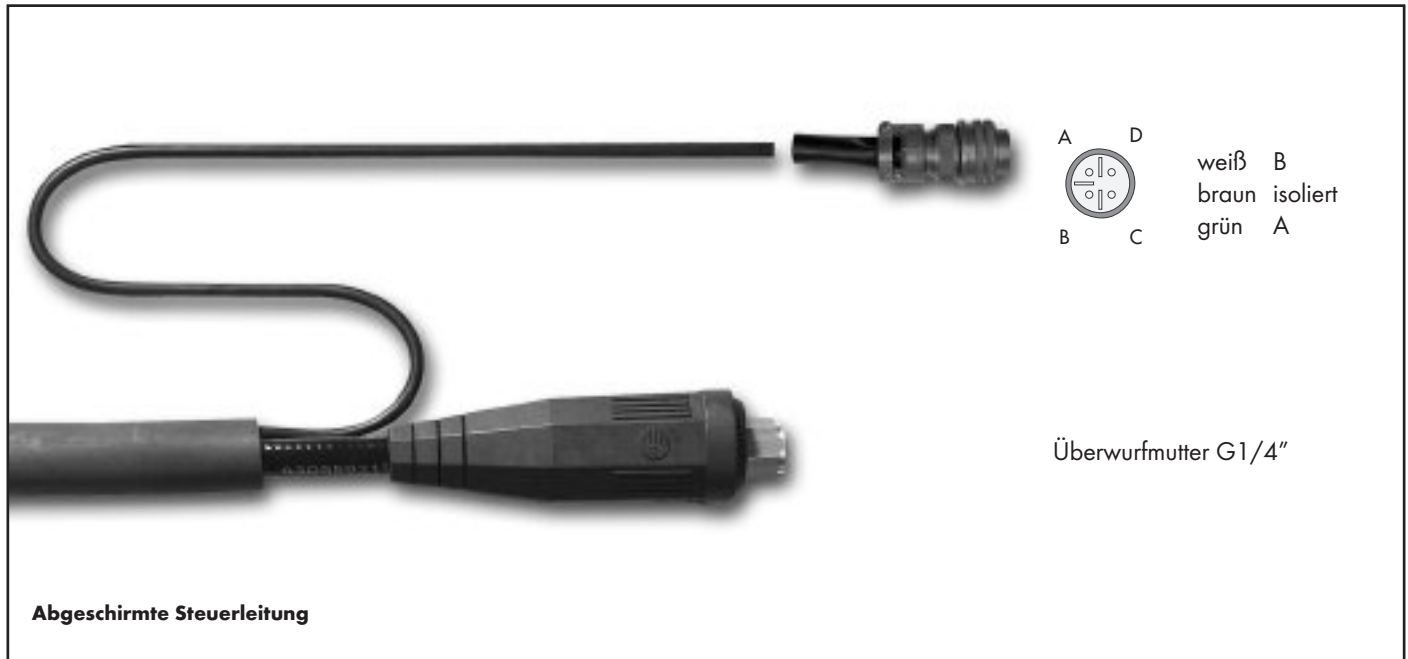

Brennertyp	Länge	Schalterfunktion	maschinenseitiger Anschluss	Schlauchpaketausführung	Bestellnummer
ABITIG® 9	4 m	ED	EA Amphenol 4-pol.	Standard	7S1SK047011110A00
	8 m	ED	EA Amphenol 4-pol.	Standard	7S1SK087011110A00
	4 m	ED	EA Amphenol 4-pol.	High Flex Leder	7S1SH047011110A00
	8 m	ED	EA Amphenol 4-pol.	High Flex Leder	7S1SH087011110A00
ABITIG® 9F	4 m	ED	EA Amphenol 4-pol.	Standard	7S1FK047011110A00
	8 m	ED	EA Amphenol 4-pol.	Standard	7S1FK087011110A00
	4 m	ED	EA Amphenol 4-pol.	High Flex Leder	7S1FH047011110A00
	8 m	ED	EA Amphenol 4-pol.	High Flex Leder	7S1FH087011110A00
ABITIG® 17	4 m	ED	EA Amphenol 4-pol.	Standard	7S2SK047011110A00
	8 m	ED	EA Amphenol 4-pol.	Standard	7S2SK087011110A00
	4 m	ED	EA Amphenol 4-pol.	High Flex Leder	7S2SH047011110A00
	8 m	ED	EA Amphenol 4-pol.	High Flex Leder	7S2SH087011110A00
ABITIG® 17F	4 m	ED	EA Amphenol 4-pol.	Standard	7S2FK047011110A00
	8 m	ED	EA Amphenol 4-pol.	Standard	7S2FK087011110A00
	4 m	ED	EA Amphenol 4-pol.	High Flex Leder	7S2FH047011110A00
	8 m	ED	EA Amphenol 4-pol.	High Flex Leder	7S2FH087011110A00

Technische Änderungen vorbehalten • Verkaufspreise = unverbindliche Preisempfehlung - Angebot freibleibend • © Copyright

ABITIG®-Brennerpreisliste

passend für WIG-Stromquellen des Fabrikates „kemppi“

Brennertyp	Länge	Schalterfunktion	maschinenseitiger Anschluss	Schlauchpaketausführung	Bestellnummer
ABITIG® 26	4 m	ED	EA Amphenol 4-pol.	Standard	7S3SK047011110A00
	8 m	ED	EA Amphenol 4-pol.	Standard	7S3SK087011110A00
	4 m	ED	EA Amphenol 4-pol.	High Flex Leder	7S3SH047011110A00
	8 m	ED	EA Amphenol 4-pol.	High Flex Leder	7S3SH087011110A00
ABITIG® 26F	4 m	ED	EA Amphenol 4-pol.	Standard	7S3FK047011110A00
	8 m	ED	EA Amphenol 4-pol.	Standard	7S3FK087011110A00
	4 m	ED	EA Amphenol 4-pol.	High Flex Leder	7S3FH047011110A00
	8 m	ED	EA Amphenol 4-pol.	High Flex Leder	7S3FH087011110A00
ABITIG® 24G	4 m	ED	EA Amphenol 4-pol.	Standard	7S8SK047011110A00
	8 m	ED	EA Amphenol 4-pol.	Standard	7S8SK087011110A00
	4 m	ED	EA Amphenol 4-pol.	High Flex Leder	7S8SH047011110A00
	8 m	ED	EA Amphenol 4-pol.	High Flex Leder	7S8SH087011110A00
ABITIG® 200	4 m	ED	EA Amphenol 4-pol.	Standard	7T4SK047011110A00
	8 m	ED	EA Amphenol 4-pol.	Standard	7T4SK087011110A00
	4 m	ED	EA Amphenol 4-pol.	High Flex Leder	7T4SH047011110A00
	8 m	ED	EA Amphenol 4-pol.	High Flex Leder	7T4SH087011110A00
ABITIG® 200F	4 m	ED	EA Amphenol 4-pol.	Standard	7T4FK047011110A00
	8 m	ED	EA Amphenol 4-pol.	Standard	7T4FK087011110A00
	4 m	ED	EA Amphenol 4-pol.	High Flex Leder	7T4FH047011110A00
	8 m	ED	EA Amphenol 4-pol.	High Flex Leder	7T4FH087011110A00
ABITIG® 150	4 m	ED	EA Amphenol 4-pol.	Standard	7T6SK047011110A00
	8 m	ED	EA Amphenol 4-pol.	Standard	7T6SK087011110A00
	4 m	ED	EA Amphenol 4-pol.	High Flex Leder	7T6SH047011110A00
	8 m	ED	EA Amphenol 4-pol.	High Flex Leder	7T6SH087011110A00
ABITIG® 150F	4 m	ED	EA Amphenol 4-pol.	Standard	7T6FK047011110A00
	8 m	ED	EA Amphenol 4-pol.	Standard	7T6FK087011110A00
	4 m	ED	EA Amphenol 4-pol.	High Flex Leder	7T6FH047011110A00
	8 m	ED	EA Amphenol 4-pol.	High Flex Leder	7T6FH087011110A00

ABITIG®-Brennerpreisliste

passend für WIG-Stromquellen des Fabrikates „kemppi“



Abgeschirmte Steuerleitung

Brennertyp	Länge	Schalterfunktion	maschinenseitiger Anschluss	Schlauchpaketausführung	Bestellnummer
ABITIG® 9	4 m	ED	ZA 9-pol.	Standard	7S1SK047010799A00
	8 m	ED	ZA 9-pol.	Standard	7S1SK087010799A00
	4 m	ED	ZA 9-pol.	High Flex Leder	7S1SH047010799A00
	8 m	ED	ZA 9-pol.	High Flex Leder	7S1SH087010799A00
ABITIG® 9 F	4 m	ED	ZA 9-pol.	Standard	7S1FK047010799A00
	8 m	ED	ZA 9-pol.	Standard	7S1FK087010799A00
	4 m	ED	ZA 9-pol.	High Flex Leder	7S1FH047010799A00
	8 m	ED	ZA 9-pol.	High Flex Leder	7S1FH087010799A00
ABITIG® 17	4 m	ED	ZA 9-pol.	Standard	7S2SK047010799A00
	8 m	ED	ZA 9-pol.	Standard	7S2SK087010799A00
	4 m	ED	ZA 9-pol.	High Flex Leder	7S2SH047010799A00
	8 m	ED	ZA 9-pol.	High Flex Leder	7S2SH087010799A00
ABITIG® 17 F	4 m	ED	ZA 9-pol.	Standard	7S2FK047010799A00
	8 m	ED	ZA 9-pol.	Standard	7S2FK087010799A00
	4 m	ED	ZA 9-pol.	High Flex Leder	7S2FH047010799A00
	8 m	ED	ZA 9-pol.	High Flex Leder	7S2FH087010799A00

Technische Änderungen vorbehalten • Verkaufspreise = unverbindliche Preisempfehlung - Angebot freibleibend • © Copyright

ABITIG®-Brennerpreisliste

passend für WIG-Stromquellen des Fabrikates „kemppi“

Brennertyp	Länge	Schalterfunktion	maschinenseitiger Anschluss	Schlauchpaketausführung	Bestellnummer
ABITIG® 26	4 m	ED	ZA 9-pol.	Standard	7S3SK047010799A00
	8 m	ED	ZA 9-pol.	Standard	7S3SK087010799A00
	4 m	ED	ZA 9-pol.	High Flex Leder	7S3SH047010799A00
	8 m	ED	ZA 9-pol.	High Flex Leder	7S3SH087010799A00

ABITIG® 26 F	4 m	ED	ZA 9-pol.	Standard	7S3FK047010799A00
	8 m	ED	ZA 9-pol.	Standard	7S3FK087010799A00
	4 m	ED	ZA 9-pol.	High Flex Leder	7S3FH047010799A00
	8 m	ED	ZA 9-pol.	High Flex Leder	7S3FH087010799A00

ABITIG® 24G	4 m	ED	ZA 9-pol.	Standard	7S8SK047010799A00
	8 m	ED	ZA 9-pol.	Standard	7S8SK087010799A00
	4 m	ED	ZA 9-pol.	High Flex Leder	7S8SH047010799A00
	8 m	ED	ZA 9-pol.	High Flex Leder	7S8SH087010799A00

ABITIG® 200	4 m	ED	ZA 9-pol.	Standard	7T4SK047010799A00
	8 m	ED	ZA 9-pol.	Standard	7T4SK087010799A00
	4 m	ED	ZA 9-pol.	High Flex Leder	7T4SH047010799A00
	8 m	ED	ZA 9-pol.	High Flex Leder	7T4SH087010799A00

ABITIG® 200F	4 m	ED	ZA 9-pol.	Standard	7T4FK047010799A00
	8 m	ED	ZA 9-pol.	Standard	7T4FK087010799A00
	4 m	ED	ZA 9-pol.	High Flex Leder	7T4FH047010799A00
	8 m	ED	ZA 9-pol.	High Flex Leder	7T4FH087010799A00

ABITIG® 150	4 m	ED	ZA 9-pol.	Standard	7T6SK047010799A00
	8 m	ED	ZA 9-pol.	Standard	7T6SK087010799A00
	4 m	ED	ZA 9-pol.	High Flex Leder	7T6SH047010799A00
	8 m	ED	ZA 9-pol.	High Flex Leder	7T6SH087010799A00

ABITIG® 150F	4 m	ED	ZA 9-pol.	Standard	7T6FK047010799A00
	8 m	ED	ZA 9-pol.	Standard	7T6FK087010799A00
	4 m	ED	ZA 9-pol.	High Flex Leder	7T6FH047010799A00
	8 m	ED	ZA 9-pol.	High Flex Leder	7T6FH087010799A00

ABITIG®-Brennerpreisliste

passend für WIG-Stromquellen des Fabrikates „kemppi“



Brennertyp	Länge	Schalterfunktion	maschinenseitiger Anschluss	Schlauchpaketausführung	Bestellnummer
ABITIG® 9	4 m	EDP	EA Amphenol 4-pol. + Amphenol 10-pol.	Standard	7S1SK047041131A00
	8 m	EDP	EA Amphenol 4-pol. + Amphenol 10-pol.	Standard	7S1SK087041131A00
	4 m	EDP	EA Amphenol 4-pol. + Amphenol 10-pol.	High Flex Leder	7S1SH047041131A00
	8 m	EDP	EA Amphenol 4-pol. + Amphenol 10-pol.	High Flex Leder	7S1SH087041131A00
ABITIG® 9F	4 m	EDP	EA Amphenol 4-pol. + Amphenol 10-pol.	Standard	7S1FK047041131A00
	8 m	EDP	EA Amphenol 4-pol. + Amphenol 10-pol.	Standard	7S1FK087041131A00
	4 m	EDP	EA Amphenol 4-pol. + Amphenol 10-pol.	High Flex Leder	7S1FH047041131A00
	8 m	EDP	EA Amphenol 4-pol. + Amphenol 10-pol.	High Flex Leder	7S1FH087041131A00
ABITIG® 17	4 m	EDP	EA Amphenol 4-pol. + Amphenol 10-pol.	Standard	7S2SK047041131A00
	8 m	EDP	EA Amphenol 4-pol. + Amphenol 10-pol.	Standard	7S2SK087041131A00
	4 m	EDP	EA Amphenol 4-pol. + Amphenol 10-pol.	High Flex Leder	7S2SH047041131A00
	8 m	EDP	EA Amphenol 4-pol. + Amphenol 10-pol.	High Flex Leder	7S2SH087041131A00
ABITIG® 17F	4 m	EDP	EA Amphenol 4-pol. + Amphenol 10-pol.	Standard	7S2FK047041131A00
	8 m	EDP	EA Amphenol 4-pol. + Amphenol 10-pol.	Standard	7S2FK087041131A00
	4 m	EDP	EA Amphenol 4-pol. + Amphenol 10-pol.	High Flex Leder	7S2FH047041131A00
	8 m	EDP	EA Amphenol 4-pol. + Amphenol 10-pol.	High Flex Leder	7S2FH087041131A00

Technische Änderungen vorbehalten • Verkaufspreise = unverbindliche Preisempfehlung - Angebot freibleibend • © Copyright

ABITIG®-Brennerpreisliste

passend für WIG-Stromquellen des Fabrikates „kempfi“

Brennertyp	Länge	Schalterfunktion	maschinenseitiger Anschluss	Schlauchpaketausführung	Bestellnummer
ABITIG® 26	4 m	EDP	EA Amphenol 4-pol. + Amphenol 10-pol.	Standard	7S3SK047041131A00
	8 m	EDP	EA Amphenol 4-pol. + Amphenol 10-pol.	Standard	7S3SK087041131A00
	4 m	EDP	EA Amphenol 4-pol. + Amphenol 10-pol.	High Flex Leder	7S3SH047041131A00
	8 m	EDP	EA Amphenol 4-pol. + Amphenol 10-pol.	High Flex Leder	7S3SH087041131A00
ABITIG® 26F	4 m	EDP	EA Amphenol 4-pol. + Amphenol 10-pol.	Standard	7S3FK047041131A00
	8 m	EDP	EA Amphenol 4-pol. + Amphenol 10-pol.	Standard	7S3FK087041131A00
	4 m	EDP	EA Amphenol 4-pol. + Amphenol 10-pol.	High Flex Leder	7S3FH047041131A00
	8 m	EDP	EA Amphenol 4-pol. + Amphenol 10-pol.	High Flex Leder	7S3FH087041131A00
ABITIG® 24G	4 m	EDP	EA Amphenol 4-pol. + Amphenol 10-pol.	Standard	7S8SK047041131A00
	8 m	EDP	EA Amphenol 4-pol. + Amphenol 10-pol.	Standard	7S8SK087041131A00
	4 m	EDP	EA Amphenol 4-pol. + Amphenol 10-pol.	High Flex Leder	7S8SH047041131A00
	8 m	EDP	EA Amphenol 4-pol. + Amphenol 10-pol.	High Flex Leder	7S8SH087041131A00
ABITIG® 200	4 m	EDP	EA Amphenol 4-pol. + Amphenol 10-pol.	Standard	7T4SK047041131A00
	8 m	EDP	EA Amphenol 4-pol. + Amphenol 10-pol.	Standard	7T4SK087041131A00
	4 m	EDP	EA Amphenol 4-pol. + Amphenol 10-pol.	High Flex Leder	7T4SH047041131A00
	8 m	EDP	EA Amphenol 4-pol. + Amphenol 10-pol.	High Flex Leder	7T4SH087041131A00
ABITIG® 200F	4 m	EDP	EA Amphenol 4-pol. + Amphenol 10-pol.	Standard	7T4FK047041131A00
	8 m	EDP	EA Amphenol 4-pol. + Amphenol 10-pol.	Standard	7T4FK087041131A00
	4 m	EDP	EA Amphenol 4-pol. + Amphenol 10-pol.	High Flex Leder	7T4FH047041131A00
	8 m	EDP	EA Amphenol 4-pol. + Amphenol 10-pol.	High Flex Leder	7T4FH087041131A00
ABITIG® 150	4 m	EDP	EA Amphenol 4-pol. + Amphenol 10-pol.	Standard	7T6SK047041131A00
	8 m	EDP	EA Amphenol 4-pol. + Amphenol 10-pol.	Standard	7T6SK087041131A00
	4 m	EDP	EA Amphenol 4-pol. + Amphenol 10-pol.	High Flex Leder	7T6SH047041131A00
	8 m	EDP	EA Amphenol 4-pol. + Amphenol 10-pol.	High Flex Leder	7T6SH087041131A00
ABITIG® 150F	4 m	EDP	EA Amphenol 4-pol. + Amphenol 10-pol.	Standard	7T6FK047041131A00
	8 m	EDP	EA Amphenol 4-pol. + Amphenol 10-pol.	Standard	7T6FK087041131A00
	4 m	EDP	EA Amphenol 4-pol. + Amphenol 10-pol.	High Flex Leder	7T6FH047041131A00
	8 m	EDP	EA Amphenol 4-pol. + Amphenol 10-pol.	High Flex Leder	7T6FH087041131A00

ABITIG®-Brennerpreisliste

passend für WIG-Stromquellen des Fabrikates „kemppi“



Brennertyp	Länge	Schalterfunktion	maschinenseitiger Anschluss	Schlauchpaketausführung	Bestellnummer
ABITIG® 9	4 m	ED	EA Amphenol 7-pol.	Standard	7S1SK047011146A00
	8 m	ED	EA Amphenol 7-pol.	Standard	7S1SK087011146A00
	4 m	ED	EA Amphenol 7-pol.	High Flex Leder	7S1SH047011146A00
	8 m	ED	EA Amphenol 7-pol.	High Flex Leder	7S1SH087011146A00
ABITIG® 9F	4 m	ED	EA Amphenol 7-pol.	Standard	7S1FK047011146A00
	8 m	ED	EA Amphenol 7-pol.	Standard	7S1FK087011146A00
	4 m	ED	EA Amphenol 7-pol.	High Flex Leder	7S1FH047011146A00
	8 m	ED	EA Amphenol 7-pol.	High Flex Leder	7S1FH087011146A00
ABITIG® 17	4 m	ED	EA Amphenol 7-pol.	Standard	7S2SK047011146A00
	8 m	ED	EA Amphenol 7-pol.	Standard	7S2SK087011146A00
	4 m	ED	EA Amphenol 7-pol.	High Flex Leder	7S2SH047011146A00
	8 m	ED	EA Amphenol 7-pol.	High Flex Leder	7S2SH087011146A00
ABITIG® 17F	4 m	ED	EA Amphenol 7-pol.	Standard	7S2FK047011146A00
	8 m	ED	EA Amphenol 7-pol.	Standard	7S2FK087011146A00
	4 m	ED	EA Amphenol 7-pol.	High Flex Leder	7S2FH047011146A00
	8 m	ED	EA Amphenol 7-pol.	High Flex Leder	7S2FH087011146A00

Technische Änderungen vorbehalten • Verkaufspreise = unverbindliche Preisempfehlung - Angebot freibleibend • © Copyright

ABITIG®-Brennerpreisliste

passend für WIG-Stromquellen des Fabrikates „kempfi“

Brennertyp	Länge	Schalterfunktion	maschinenseitiger Anschluss	Schlauchpaketausführung	Bestellnummer
ABITIG® 26	4 m	ED	EA Amphenol 7-pol.	Standard	7S3SK047011146A00
	8 m	ED	EA Amphenol 7-pol.	Standard	7S3SK087011146A00
	4 m	ED	EA Amphenol 7-pol.	High Flex Leder	7S3SH047011146A00
	8 m	ED	EA Amphenol 7-pol.	High Flex Leder	7S3SH087011146A00
ABITIG® 26F	4 m	ED	EA Amphenol 7-pol.	Standard	7S3FK047011146A00
	8 m	ED	EA Amphenol 7-pol.	Standard	7S3FK087011146A00
	4 m	ED	EA Amphenol 7-pol.	High Flex Leder	7S3FH047011146A00
	8 m	ED	EA Amphenol 7-pol.	High Flex Leder	7S3FH087011146A00
ABITIG® 24G	4 m	ED	EA Amphenol 7-pol.	Standard	7S8SK047011146A00
	8 m	ED	EA Amphenol 7-pol.	Standard	7S8SK087011146A00
	4 m	ED	EA Amphenol 7-pol.	High Flex Leder	7S8SH047011146A00
	8 m	ED	EA Amphenol 7-pol.	High Flex Leder	7S8SH087011146A00
ABITIG® 200	4 m	ED	EA Amphenol 7-pol.	Standard	7T4SK047011146A00
	8 m	ED	EA Amphenol 7-pol.	Standard	7T4SK087011146A00
	4 m	ED	EA Amphenol 7-pol.	High Flex Leder	7T4SH047011146A00
	8 m	ED	EA Amphenol 7-pol.	High Flex Leder	7T4SH087011146A00
ABITIG® 200F	4 m	ED	EA Amphenol 7-pol.	Standard	7T4FK047011146A00
	8 m	ED	EA Amphenol 7-pol.	Standard	7T4FK087011146A00
	4 m	ED	EA Amphenol 7-pol.	High Flex Leder	7T4FH047011146A00
	8 m	ED	EA Amphenol 7-pol.	High Flex Leder	7T4FH087011146A00
ABITIG® 150	4 m	ED	EA Amphenol 7-pol.	Standard	7T6SK047011146A00
	8 m	ED	EA Amphenol 7-pol.	Standard	7T6SK087011146A00
	4 m	ED	EA Amphenol 7-pol.	High Flex Leder	7T6SH047011146A00
	8 m	ED	EA Amphenol 7-pol.	High Flex Leder	7T6SH087011146A00
ABITIG® 150F	4 m	ED	EA Amphenol 7-pol.	Standard	7T6FK047011146A00
	8 m	ED	EA Amphenol 7-pol.	Standard	7T6FK087011146A00
	4 m	ED	EA Amphenol 7-pol.	High Flex Leder	7T6FH047011146A00
	8 m	ED	EA Amphenol 7-pol.	High Flex Leder	7T6FH087011146A00

ABITIG®-Brennerpreisliste

passend für WIG-Stromquellen des Fabrikates „kemppi“



Brennertyp	Länge	Schalterfunktion	maschinenseitiger Anschluss	Schlauchpaketausführung	Bestellnummer
ABITIG® 9	4 m	EDP	EA Amphenol 7-pol.	Standard	7S1SK047041146C00
	8 m	EDP	EA Amphenol 7-pol.	Standard	7S1SK087041146C00
	4 m	EDP	EA Amphenol 7-pol.	High Flex Leder	7S1SH047041146C00
	8 m	EDP	EA Amphenol 7-pol.	High Flex Leder	7S1SH087041146C00
ABITIG® 9F	4 m	EDP	EA Amphenol 7-pol.	Standard	7S1FK047041146C00
	8 m	EDP	EA Amphenol 7-pol.	Standard	7S1FK087041146C00
	4 m	EDP	EA Amphenol 7-pol.	High Flex Leder	7S1FH047041146C00
	8 m	EDP	EA Amphenol 7-pol.	High Flex Leder	7S1FH087041146C00
ABITIG® 17	4 m	EDP	EA Amphenol 7-pol.	Standard	7S2SK047041146C00
	8 m	EDP	EA Amphenol 7-pol.	Standard	7S2SK087041146C00
	4 m	EDP	EA Amphenol 7-pol.	High Flex Leder	7S2SH047041146C00
	8 m	EDP	EA Amphenol 7-pol.	High Flex Leder	7S2SH087041146C00
ABITIG® 17F	4 m	EDP	EA Amphenol 7-pol.	Standard	7S2FK047041146C00
	8 m	EDP	EA Amphenol 7-pol.	Standard	7S2FK087041146C00
	4 m	EDP	EA Amphenol 7-pol.	High Flex Leder	7S2FH047041146C00
	8 m	EDP	EA Amphenol 7-pol.	High Flex Leder	7S2FH087041146C00

Technische Änderungen vorbehalten • Verkaufspreise = unverbindliche Preisempfehlung - Angebot freibleibend • © Copyright

ABITIG®-Brennerpreisliste

passend für WIG-Stromquellen des Fabrikates „kemppi“

Brennertyp	Länge	Schalterfunktion	maschinenseitiger Anschluss	Schlauchpaketausführung	Bestellnummer
ABITIG® 26	4 m	EDP	EA Amphenol 7-pol.	Standard	7S3SK047041146C00
	8 m	EDP	EA Amphenol 7-pol.	Standard	7S3SK087041146C00
	4 m	EDP	EA Amphenol 7-pol.	High Flex Leder	7S3SH047041146C00
	8 m	EDP	EA Amphenol 7-pol.	High Flex Leder	7S3SH087041146C00

ABITIG® 26F	4 m	EDP	EA Amphenol 7-pol.	Standard	7S3FK047041146C00
	8 m	EDP	EA Amphenol 7-pol.	Standard	7S3FK087041146C00
	4 m	EDP	EA Amphenol 7-pol.	High Flex Leder	7S3FH047041146C00
	8 m	EDP	EA Amphenol 7-pol.	High Flex Leder	7S3FH087041146C00

ABITIG® 24G	4 m	EDP	EA Amphenol 7-pol.	Standard	7S8SK047041146C00
	8 m	EDP	EA Amphenol 7-pol.	Standard	7S8SK087041146C00
	4 m	EDP	EA Amphenol 7-pol.	High Flex Leder	7S8SH047041146C00
	8 m	EDP	EA Amphenol 7-pol.	High Flex Leder	7S8SH087041146C00

ABITIG® 200	4 m	EDP	EA Amphenol 7-pol.	Standard	7T4SK047041146C00
	8 m	EDP	EA Amphenol 7-pol.	Standard	7T4SK087041146C00
	4 m	EDP	EA Amphenol 7-pol.	High Flex Leder	7T4SH047041146C00
	8 m	EDP	EA Amphenol 7-pol.	High Flex Leder	7T4SH087041146C00

ABITIG® 200F	4 m	EDP	EA Amphenol 7-pol.	Standard	7T4FK047041146C00
	8 m	EDP	EA Amphenol 7-pol.	Standard	7T4FK087041146C00
	4 m	EDP	EA Amphenol 7-pol.	High Flex Leder	7T4FH047041146C00
	8 m	EDP	EA Amphenol 7-pol.	High Flex Leder	7T4FH087041146C00

ABITIG® 150	4 m	EDP	EA Amphenol 7-pol.	Standard	7T6SK047041146C00
	8 m	EDP	EA Amphenol 7-pol.	Standard	7T6SK087041146C00
	4 m	EDP	EA Amphenol 7-pol.	High Flex Leder	7T6SH047041146C00
	8 m	EDP	EA Amphenol 7-pol.	High Flex Leder	7T6SH087041146C00

ABITIG® 150F	4 m	EDP	EA Amphenol 7-pol.	Standard	7T6FK047041146C00
	8 m	EDP	EA Amphenol 7-pol.	Standard	7T6FK087041146C00
	4 m	EDP	EA Amphenol 7-pol.	High Flex Leder	7T6FH047041146C00
	8 m	EDP	EA Amphenol 7-pol.	High Flex Leder	7T6FH087041146C00

ABITIG®-Brennerpreisliste

passend für WIG-Stromquellen des Fabrikates „kemppi“ Up/Down

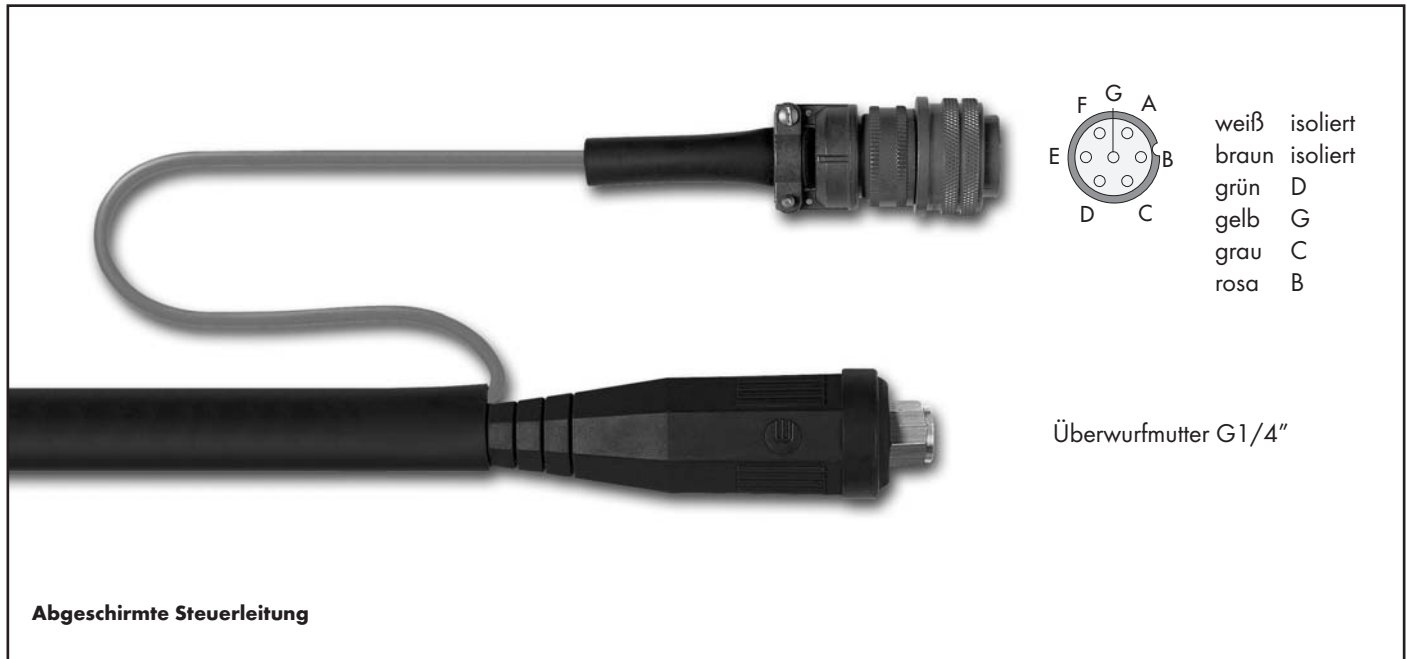

Brennertyp	Länge	Schalterfunktion	maschinenseitiger Anschluss	Schlauchpaketausführung	Bestellnummer
ABITIG® 9	4 m	UD	EA Amphenol 7-pol.	Standard	7S1SK047151132B00
	8 m	UD	EA Amphenol 7-pol.	Standard	7S1SK087151132B00
	4 m	UD	EA Amphenol 7-pol.	High Flex Leder	7S1SH047151132B00
	8 m	UD	EA Amphenol 7-pol.	High Flex Leder	7S1SH087151132B00

ABITIG® 9F	4 m	UD	EA Amphenol 7-pol.	Standard	7S1FK047151132B00
	8 m	UD	EA Amphenol 7-pol.	Standard	7S1FK087151132B00
	4 m	UD	EA Amphenol 7-pol.	High Flex Leder	7S1FH047151132B00
	8 m	UD	EA Amphenol 7-pol.	High Flex Leder	7S1FH087151132B00

ABITIG® 17	4 m	UD	EA Amphenol 7-pol.	Standard	7S2SK047151132B00
	8 m	UD	EA Amphenol 7-pol.	Standard	7S2SK087151132B00
	4 m	UD	EA Amphenol 7-pol.	High Flex Leder	7S2SH047151132B00
	8 m	UD	EA Amphenol 7-pol.	High Flex Leder	7S2SH087151132B00

ABITIG® 17F	4 m	UD	EA Amphenol 7-pol.	Standard	7S2FK047151132B00
	8 m	UD	EA Amphenol 7-pol.	Standard	7S2FK087151132B00
	4 m	UD	EA Amphenol 7-pol.	High Flex Leder	7S2FH047151132B00
	8 m	UD	EA Amphenol 7-pol.	High Flex Leder	7S2FH087151132B00

ABITIG®-Brennerpreisliste

passend für WIG-Stromquellen des Fabrikates „kemppi“ Up/Down

Brennertyp	Länge	Schalterfunktion	maschinenseitiger Anschluss	Schlauchpaketausführung	Bestellnummer
ABITIG® 26	4 m	UD	EA Amphenol 7-pol.	Standard	7S3SK047151132B00
	8 m	UD	EA Amphenol 7-pol.	Standard	7S3SK087151132B00
	4 m	UD	EA Amphenol 7-pol.	High Flex Leder	7S3SH047151132B00
	8 m	UD	EA Amphenol 7-pol.	High Flex Leder	7S3SH087151132B00
ABITIG® 26F	4 m	UD	EA Amphenol 7-pol.	Standard	7S3FK047151132B00
	8 m	UD	EA Amphenol 7-pol.	Standard	7S3FK087151132B00
	4 m	UD	EA Amphenol 7-pol.	High Flex Leder	7S3FH047151132B00
	8 m	UD	EA Amphenol 7-pol.	High Flex Leder	7S3FH087151132B00
ABITIG® 24G	4 m	UD	EA Amphenol 7-pol.	Standard	7S8SK047151132B00
	8 m	UD	EA Amphenol 7-pol.	Standard	7S8SK087151132B00
	4 m	UD	EA Amphenol 7-pol.	High Flex Leder	7S8SH047151132B00
	8 m	UD	EA Amphenol 7-pol.	High Flex Leder	7S8SH087151132B00
ABITIG® 200	4 m	UD	EA Amphenol 7-pol.	Standard	7T4SK047151132B00
	8 m	UD	EA Amphenol 7-pol.	Standard	7T4SK087151132B00
	4 m	UD	EA Amphenol 7-pol.	High Flex Leder	7T4SH047151132B00
	8 m	UD	EA Amphenol 7-pol.	High Flex Leder	7T4SH087151132B00
ABITIG® 200F	4 m	UD	EA Amphenol 7-pol.	Standard	7T4FK047151132B00
	8 m	UD	EA Amphenol 7-pol.	Standard	7T4FK087151132B00
	4 m	UD	EA Amphenol 7-pol.	High Flex Leder	7T4FH047151132B00
	8 m	UD	EA Amphenol 7-pol.	High Flex Leder	7T4FH087151132B00
ABITIG® 150	4 m	UD	EA Amphenol 7-pol.	Standard	7T6SK047151132B00
	8 m	UD	EA Amphenol 7-pol.	Standard	7T6SK087151132B00
	4 m	UD	EA Amphenol 7-pol.	High Flex Leder	7T6SH047151132B00
	8 m	UD	EA Amphenol 7-pol.	High Flex Leder	7T6SH087151132B00
ABITIG® 150F	4 m	UD	EA Amphenol 7-pol.	Standard	7T6FK047151132B00
	8 m	UD	EA Amphenol 7-pol.	Standard	7T6FK087151132B00
	4 m	UD	EA Amphenol 7-pol.	High Flex Leder	7T6FH047151132B00
	8 m	UD	EA Amphenol 7-pol.	High Flex Leder	7T6FH087151132B00

ABITIG®-Brennerpreisliste

passend für WIG-Stromquellen des Fabrikates „kemppi“

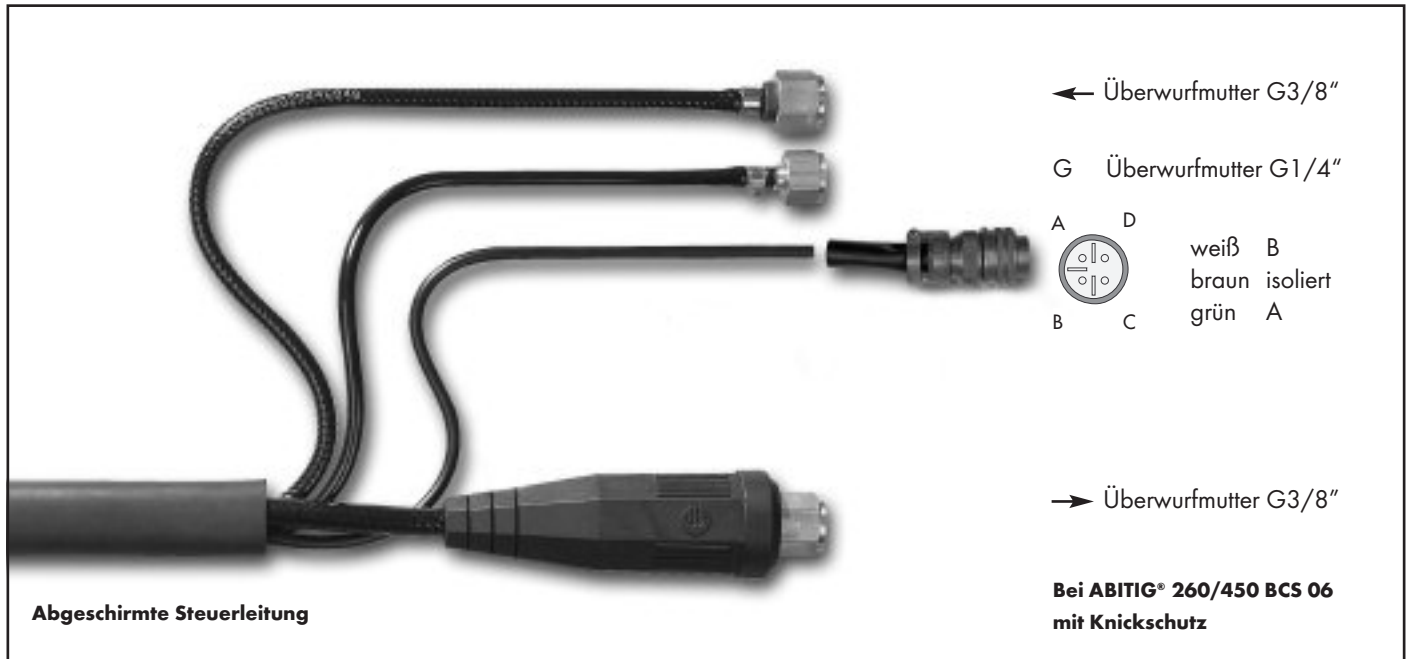

Brennertyp	Länge	Schalterfunktion	maschinenseitiger Anschluss	Schlauchpaketausführung	Bestellnummer
ABITIG® 18	4 m	ED	EA Amphenol 4-pol.	Standard	7S4SK047010610A15
	8 m	ED	EA Amphenol 4-pol.	Standard	7S4SK087010610A15
	4 m	ED	EA Amphenol 4-pol.	High Flex Leder	7S4SH047010610A15
	8 m	ED	EA Amphenol 4-pol.	High Flex Leder	7S4SH087010610A15
ABITIG® 18F	4 m	ED	EA Amphenol 4-pol.	Standard	7S4FK047010610A15
	8 m	ED	EA Amphenol 4-pol.	Standard	7S4FK087010610A15
	4 m	ED	EA Amphenol 4-pol.	High Flex Leder	7S4FH047010610A15
	8 m	ED	EA Amphenol 4-pol.	High Flex Leder	7S4FH087010610A15
ABITIG® 20	4 m	ED	EA Amphenol 4-pol.	Standard	7S5SK047010610A15
	8 m	ED	EA Amphenol 4-pol.	Standard	7S5SK087010610A15
	4 m	ED	EA Amphenol 4-pol.	High Flex Leder	7S5SH047010610A15
	8 m	ED	EA Amphenol 4-pol.	High Flex Leder	7S5SH087010610A15
ABITIG® 20F	4 m	ED	EA Amphenol 4-pol.	Standard	7S5FK047010610A15
	8 m	ED	EA Amphenol 4-pol.	Standard	7S5FK087010610A15
	4 m	ED	EA Amphenol 4-pol.	High Flex Leder	7S5FH047010610A15
	8 m	ED	EA Amphenol 4-pol.	High Flex Leder	7S5FH087010610A15

Technische Änderungen vorbehalten • Verkaufspreise = unverbindliche Preisempfehlung - Angebot freibleibend • © Copyright

ABITIG®-Brennerpreisliste

passend für WIG-Stromquellen des Fabrikates „kempfi“

Brennertyp	Länge	Schalterfunktion	maschinenseitiger Anschluss	Schlauchpaketausführung	Bestellnummer
ABITIG® 12-1	4 m	ED	EA Amphenol 4-pol.	Standard	7S6SK047010610A15
	8 m	ED	EA Amphenol 4-pol.	Standard	7S6SK087010610A15
	4 m	ED	EA Amphenol 4-pol.	High Flex Leder	7S6SH047010610A15
	8 m	ED	EA Amphenol 4-pol.	High Flex Leder	7S6SH087010610A15
ABITIG® 18SC	4 m	ED	EA Amphenol 4-pol.	Standard	7S7SK047010610A15
	8 m	ED	EA Amphenol 4-pol.	Standard	7S7SK087010610A15
	4 m	ED	EA Amphenol 4-pol.	High Flex Leder	7S7SH047010610A15
	8 m	ED	EA Amphenol 4-pol.	High Flex Leder	7S7SH087010610A15
ABITIG® 24W	4 m	ED	EA Amphenol 4-pol.	Standard	7S9SK047010610A15
	8 m	ED	EA Amphenol 4-pol.	Standard	7S9SK087010610A15
	4 m	ED	EA Amphenol 4-pol.	High Flex Leder	7S9SH047010610A15
	8 m	ED	EA Amphenol 4-pol.	High Flex Leder	7S9SH087010610A15
ABITIG® 450W	4 m	ED	EA Amphenol 4-pol.	Standard	7T5SK047010610A15
	8 m	ED	EA Amphenol 4-pol.	Standard	7T5SK087010610A15
	4 m	ED	EA Amphenol 4-pol.	High Flex Leder	7T5SH047010610A15
	8 m	ED	EA Amphenol 4-pol.	High Flex Leder	7T5SH087010610A15
ABITIG® 260W	4 m	ED	EA Amphenol 4-pol.	Standard	7T7SK047010610A15
	8 m	ED	EA Amphenol 4-pol.	Standard	7T7SK087010610A15
	4 m	ED	EA Amphenol 4-pol.	High Flex Leder	7T7SH047010610A15
	8 m	ED	EA Amphenol 4-pol.	High Flex Leder	7T7SH087010610A15
ABITIG® 450W SC	4 m	ED	EA Amphenol 4-pol.	Standard	
	8 m	ED	EA Amphenol 4-pol.	Standard	
	4 m	ED	EA Amphenol 4-pol.	High Flex Leder	7T8SH047010610A15
	8 m	ED	EA Amphenol 4-pol.	High Flex Leder	7T8SH087010610A15

ABITIG®-Brennerpreisliste

passend für WIG-Stromquellen des Fabrikates „kemppi“



Brennertyp	Länge	Schalterfunktion	maschinenseitiger Anschluss	Schlauchpaketausführung	Bestellnummer
ABITIG® 18	4 m	ED	ZA 9-pol.	Standard	7S4SK047010799B12
	8 m	ED	ZA 9-pol.	Standard	7S4SK087010799B12
	4 m	ED	ZA 9-pol.	High Flex Leder	7S4SH047010799B12
	8 m	ED	ZA 9-pol.	High Flex Leder	7S4SH087010799B12
ABITIG® 18F	4 m	ED	ZA 9-pol.	Standard	7S4FK047010799B12
	8 m	ED	ZA 9-pol.	Standard	7S4FK087010799B12
	4 m	ED	ZA 9-pol.	High Flex Leder	7S4FH047010799B12
	8 m	ED	ZA 9-pol.	High Flex Leder	7S4FH087010799B12
ABITIG® 20	4 m	ED	ZA 9-pol.	Standard	7S5SK047010799B12
	8 m	ED	ZA 9-pol.	Standard	7S5SK087010799B12
	4 m	ED	ZA 9-pol.	High Flex Leder	7S5SH047010799B12
	8 m	ED	ZA 9-pol.	High Flex Leder	7S5SH087010799B12
ABITIG® 20F	4 m	ED	ZA 9-pol.	Standard	7S5FK047010799B12
	8 m	ED	ZA 9-pol.	Standard	7S5FK087010799B12
	4 m	ED	ZA 9-pol.	High Flex Leder	7S5FH047010799B12
	8 m	ED	ZA 9-pol.	High Flex Leder	7S5FH087010799B12

Technische Änderungen vorbehalten • Verkaufspreise = unverbindliche Preisempfehlung - Angebot freibleibend • © Copyright

ABITIG®-Brennerpreisliste

passend für WIG-Stromquellen des Fabrikates „kemppi“

Brennertyp	Länge	Schalterfunktion	maschinenseitiger Anschluss	Schlauchpaketausführung	Bestellnummer
ABITIG® 12-1	4 m	ED	ZA 9-pol.	Standard	7S6SK047010799B12
	8 m	ED	ZA 9-pol.	Standard	7S6SK087010799B12
	4 m	ED	ZA 9-pol.	High Flex Leder	7S6SH047010799B12
	8 m	ED	ZA 9-pol.	High Flex Leder	7S6SH087010799B12
<hr/>					
ABITIG® 18SC	4 m	ED	ZA 9-pol.	Standard	7S7SK047010799B12
	8 m	ED	ZA 9-pol.	Standard	7S7SK087010799B12
	4 m	ED	ZA 9-pol.	High Flex Leder	7S7SH047010799B12
	8 m	ED	ZA 9-pol.	High Flex Leder	7S7SH087010799B12
<hr/>					
ABITIG® 24W	4 m	ED	ZA 9-pol.	Standard	7S9SK047010799B12
	8 m	ED	ZA 9-pol.	Standard	7S9SK087010799B12
	4 m	ED	ZA 9-pol.	High Flex Leder	7S9SH047010799B12
	8 m	ED	ZA 9-pol.	High Flex Leder	7S9SH087010799B12
<hr/>					
ABITIG® 450W	4 m	ED	ZA 9-pol.	Standard	7T5SK047010799B12
	8 m	ED	ZA 9-pol.	Standard	7T5SK087010799B12
	4 m	ED	ZA 9-pol.	High Flex Leder	7T5SH047010799B12
	8 m	ED	ZA 9-pol.	High Flex Leder	7T5SH087010799B12
<hr/>					
ABITIG® 260W	4 m	ED	ZA 9-pol.	Standard	7T7SK047010799B12
	8 m	ED	ZA 9-pol.	Standard	7T7SK087010799B12
	4 m	ED	ZA 9-pol.	High Flex Leder	7T7SH047010799B12
	8 m	ED	ZA 9-pol.	High Flex Leder	7T7SH087010799B12
<hr/>					
ABITIG® 450W SC	4 m	ED	ZA 9-pol.	Standard	
	8 m	ED	ZA 9-pol.	Standard	
	4 m	ED	ZA 9-pol.	High Flex Leder	7T8SH047010799B12
	8 m	ED	ZA 9-pol.	High Flex Leder	7T8SH087010799B12

ABITIG®-Brennerpreisliste

passend für WIG-Stromquellen des Fabrikates „kemppi“

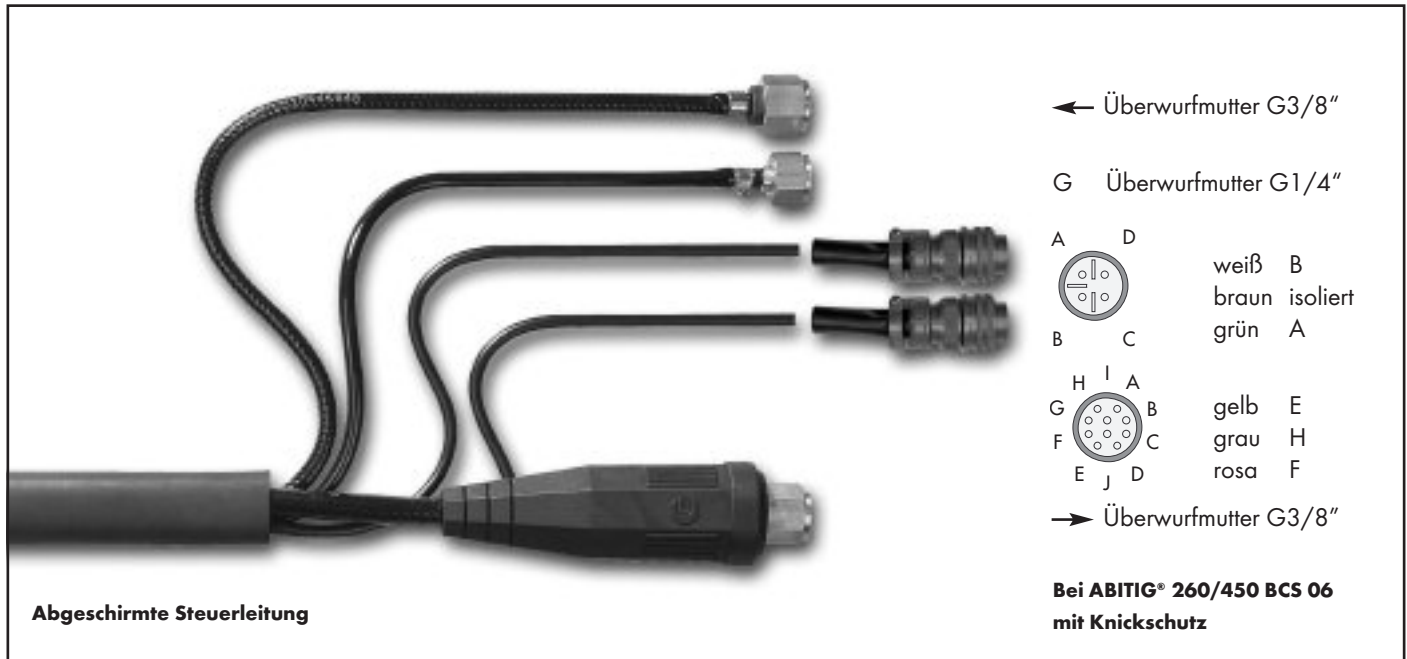

Brennertyp	Länge	Schalterfunktion	maschinenseitiger Anschluss	Schlauchpaketausführung	Bestellnummer
ABITIG® 18	4 m	EDP	EA Amphenol 4-pol. + Amphenol 10-pol.	Standard	7S4SK047040631A15
	8 m	EDP	EA Amphenol 4-pol. + Amphenol 10-pol.	Standard	7S4SK087040631A15
	4 m	EDP	EA Amphenol 4-pol. + Amphenol 10-pol.	High Flex Leder	7S4SH047040631A15
	8 m	EDP	EA Amphenol 4-pol. + Amphenol 10-pol.	High Flex Leder	7S4SH087040631A15
ABITIG® 18F	4 m	EDP	EA Amphenol 4-pol. + Amphenol 10-pol.	Standard	7S4FK047040631A15
	8 m	EDP	EA Amphenol 4-pol. + Amphenol 10-pol.	Standard	7S4FK087040631A15
	4 m	EDP	EA Amphenol 4-pol. + Amphenol 10-pol.	High Flex Leder	7S4FH047040631A15
	8 m	EDP	EA Amphenol 4-pol. + Amphenol 10-pol.	High Flex Leder	7S4FH087040631A15
ABITIG® 20	4 m	EDP	EA Amphenol 4-pol. + Amphenol 10-pol.	Standard	7S5SK047040631A15
	8 m	EDP	EA Amphenol 4-pol. + Amphenol 10-pol.	Standard	7S5SK087040631A15
	4 m	EDP	EA Amphenol 4-pol. + Amphenol 10-pol.	High Flex Leder	7S5SH047040631A15
	8 m	EDP	EA Amphenol 4-pol. + Amphenol 10-pol.	High Flex Leder	7S5SH087040631A15
ABITIG® 20F	4 m	EDP	EA Amphenol 4-pol. + Amphenol 10-pol.	Standard	7S5FK047040631A15
	8 m	EDP	EA Amphenol 4-pol. + Amphenol 10-pol.	Standard	7S5FK087040631A15
	4 m	EDP	EA Amphenol 4-pol. + Amphenol 10-pol.	High Flex Leder	7S5FH047040631A15
	8 m	EDP	EA Amphenol 4-pol. + Amphenol 10-pol.	High Flex Leder	7S5FH087040631A15

Technische Änderungen vorbehalten • Verkaufspreise = unverbindliche Preisempfehlung - Angebot freibleibend • © Copyright

ABITIG®-Brennerpreisliste

passend für WIG-Stromquellen des Fabrikates „kempfi“

Brennertyp	Länge	Schalterfunktion	maschinenseitiger Anschluss	Schlauchpaketausführung	Bestellnummer
ABITIG® 12-1	4 m	EDP	EA Amphenol 4-pol. + Amphenol 10-pol.	Standard	7S6SK047040631A15
	8 m	EDP	EA Amphenol 4-pol. + Amphenol 10-pol.	Standard	7S6SK087040631A15
	4 m	EDP	EA Amphenol 4-pol. + Amphenol 10-pol.	High Flex Leder	7S6SH047040631A15
	8 m	EDP	EA Amphenol 4-pol. + Amphenol 10-pol.	High Flex Leder	7S6SH087040631A15
ABITIG® 18SC	4 m	EDP	EA Amphenol 4-pol. + Amphenol 10-pol.	Standard	7S7SK047040631A15
	8 m	EDP	EA Amphenol 4-pol. + Amphenol 10-pol.	Standard	7S7SK087040631A15
	4 m	EDP	EA Amphenol 4-pol. + Amphenol 10-pol.	High Flex Leder	7S7SH047040631A15
	8 m	EDP	EA Amphenol 4-pol. + Amphenol 10-pol.	High Flex Leder	7S7SH087040631A15
ABITIG® 24W	4 m	EDP	EA Amphenol 4-pol. + Amphenol 10-pol.	Standard	7S9SK047040631A15
	8 m	EDP	EA Amphenol 4-pol. + Amphenol 10-pol.	Standard	7S9SK087040631A15
	4 m	EDP	EA Amphenol 4-pol. + Amphenol 10-pol.	High Flex Leder	7S9SH047040631A15
	8 m	EDP	EA Amphenol 4-pol. + Amphenol 10-pol.	High Flex Leder	7S9SH087040631A15
ABITIG® 450W	4 m	EDP	EA Amphenol 4-pol. + Amphenol 10-pol.	Standard	7T5SK047040631A15
	8 m	EDP	EA Amphenol 4-pol. + Amphenol 10-pol.	Standard	7T5SK087040631A15
	4 m	EDP	EA Amphenol 4-pol. + Amphenol 10-pol.	High Flex Leder	7T5SH047040631A15
	8 m	EDP	EA Amphenol 4-pol. + Amphenol 10-pol.	High Flex Leder	7T5SH087040631A15
ABITIG® 260W	4 m	EDP	EA Amphenol 4-pol. + Amphenol 10-pol.	Standard	7T7SK047040631A15
	8 m	EDP	EA Amphenol 4-pol. + Amphenol 10-pol.	Standard	7T7SK087040631A15
	4 m	EDP	EA Amphenol 4-pol. + Amphenol 10-pol.	High Flex Leder	7T7SH047040631A15
	8 m	EDP	EA Amphenol 4-pol. + Amphenol 10-pol.	High Flex Leder	7T7SH087040631A15
ABITIG® 450W SC	4 m	EDP	EA Amphenol 4-pol. + Amphenol 10-pol.	Standard	
	8 m	EDP	EA Amphenol 4-pol. + Amphenol 10-pol.	Standard	
	4 m	EDP	EA Amphenol 4-pol. + Amphenol 10-pol.	High Flex Leder	7T8SH047040631A15
	8 m	EDP	EA Amphenol 4-pol. + Amphenol 10-pol.	High Flex Leder	7T8SH087040631A15

ABITIG®-Brennerpreisliste

passend für WIG-Stromquellen des Fabrikates „kemppi“

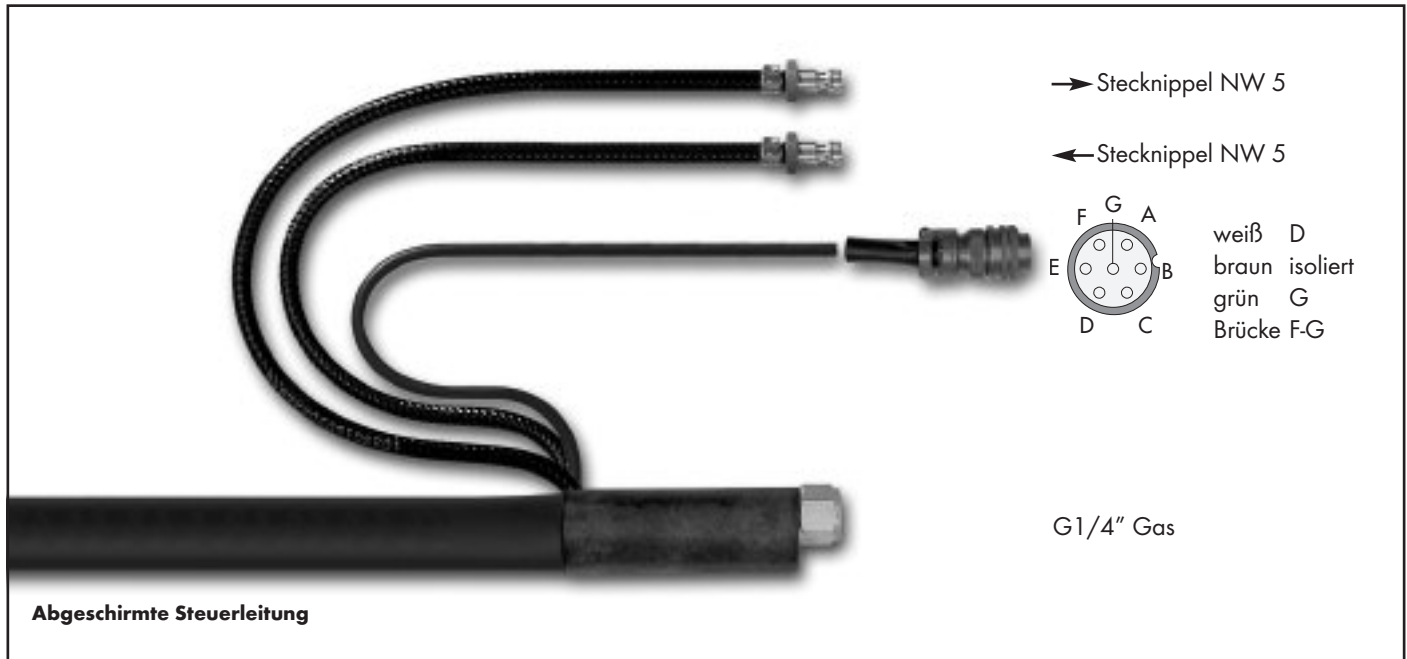

Brennertyp	Länge	Schalterfunktion	maschinenseitiger Anschluss	Schlauchpaketausführung	Bestellnummer
ABITIG® 18	4 m	ED	EA Amphenol 7-pol.	Standard	7S4SK047013546B12
	8 m	ED	EA Amphenol 7-pol.	Standard	7S4SK087013546B12
	4 m	ED	EA Amphenol 7-pol.	High Flex Leder	7S4SH047013546B12
	8 m	ED	EA Amphenol 7-pol.	High Flex Leder	7S4SH087013546B12
ABITIG® 18F	4 m	ED	EA Amphenol 7-pol.	Standard	7S4FK047013546B12
	8 m	ED	EA Amphenol 7-pol.	Standard	7S4FK087013546B12
	4 m	ED	EA Amphenol 7-pol.	High Flex Leder	7S4FH047013546B12
	8 m	ED	EA Amphenol 7-pol.	High Flex Leder	7S4FH087013546B12
ABITIG® 20	4 m	ED	EA Amphenol 7-pol.	Standard	7S5SK047013546B12
	8 m	ED	EA Amphenol 7-pol.	Standard	7S5SK087013546B12
	4 m	ED	EA Amphenol 7-pol.	High Flex Leder	7S5SH047013546B12
	8 m	ED	EA Amphenol 7-pol.	High Flex Leder	7S5SH087013546B12
ABITIG® 20F	4 m	ED	EA Amphenol 7-pol.	Standard	7S5FK047013546B12
	8 m	ED	EA Amphenol 7-pol.	Standard	7S5FK087013546B12
	4 m	ED	EA Amphenol 7-pol.	High Flex Leder	7S5FH047013546B12
	8 m	ED	EA Amphenol 7-pol.	High Flex Leder	7S5FH087013546B12

Technische Änderungen vorbehalten • Verkaufspreise = unverbindliche Preisempfehlung - Angebot freibleibend • © Copyright

ABITIG®-Brennerpreisliste

passend für WIG-Stromquellen des Fabrikates „kempfi“

Brennertyp	Länge	Schalterfunktion	maschinenseitiger Anschluss	Schlauchpaketausführung	Bestellnummer
ABITIG® 12-1	4 m	ED	EA Amphenol 7-pol.	Standard	7S6SK047013546B12
	8 m	ED	EA Amphenol 7-pol.	Standard	7S6SK087013546B12
	4 m	ED	EA Amphenol 7-pol.	High Flex Leder	7S6SH047013546B12
	8 m	ED	EA Amphenol 7-pol.	High Flex Leder	7S6SH087013546B12
ABITIG® 18SC	4 m	ED	EA Amphenol 7-pol.	Standard	7S7SK047013546B12
	8 m	ED	EA Amphenol 7-pol.	Standard	7S7SK087013546B12
	4 m	ED	EA Amphenol 7-pol.	High Flex Leder	7S7SH047013546B12
	8 m	ED	EA Amphenol 7-pol.	High Flex Leder	7S7SH087013546B12
ABITIG® 24W	4 m	ED	EA Amphenol 7-pol.	Standard	7S9SK047013546B12
	8 m	ED	EA Amphenol 7-pol.	Standard	7S9SK087013546B12
	4 m	ED	EA Amphenol 7-pol.	High Flex Leder	7S9SH047013546B12
	8 m	ED	EA Amphenol 7-pol.	High Flex Leder	7S9SH087013546B12
ABITIG® 450W	4 m	ED	EA Amphenol 7-pol.	Standard	7T5SK047013546B12
	8 m	ED	EA Amphenol 7-pol.	Standard	7T5SK087013546B12
	4 m	ED	EA Amphenol 7-pol.	High Flex Leder	7T5SH047013546B12
	8 m	ED	EA Amphenol 7-pol.	High Flex Leder	7T5SH087013546B12
ABITIG® 260W	4 m	ED	EA Amphenol 7-pol.	Standard	7T7SK047013546B12
	8 m	ED	EA Amphenol 7-pol.	Standard	7T7SK087013546B12
	4 m	ED	EA Amphenol 7-pol.	High Flex Leder	7T7SH047013546B12
	8 m	ED	EA Amphenol 7-pol.	High Flex Leder	7T7SH087013546B12
ABITIG® 450W SC	4 m	ED	EA Amphenol 7-pol.	Standard	
	8 m	ED	EA Amphenol 7-pol.	Standard	
	4 m	ED	EA Amphenol 7-pol.	High Flex Leder	7T8SH047013546B12
	8 m	ED	EA Amphenol 7-pol.	High Flex Leder	7T8SH087013546B12

ABITIG®-Brennerpreisliste

passend für WIG-Stromquellen des Fabrikates „kemppi“

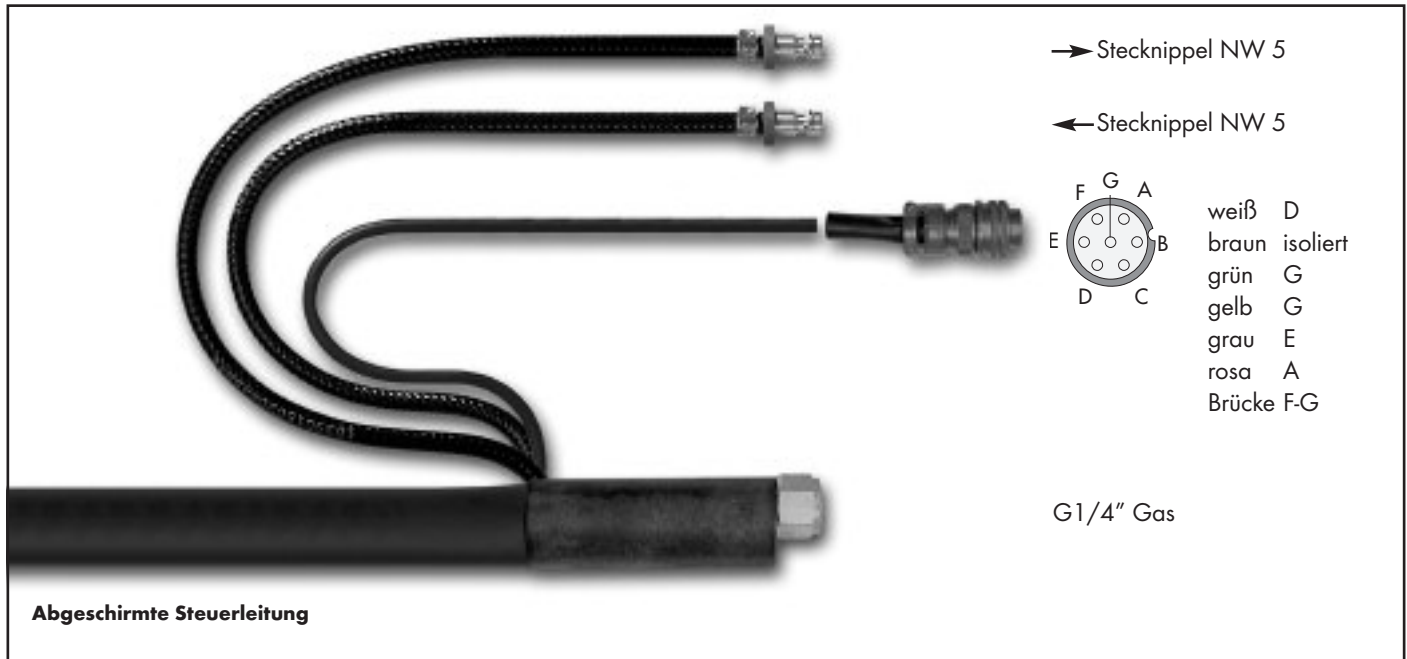

Brennertyp	Länge	Schalterfunktion	maschinenseitiger Anschluss	Schlauchpaketausführung	Bestellnummer
ABITIG® 18	4 m	EDP	EA Amphenol 7-pol.	Standard	7S4SK047043546D12
	8 m	EDP	EA Amphenol 7-pol.	Standard	7S4SK087043546D12
	4 m	EDP	EA Amphenol 7-pol.	High Flex Leder	7S4SH047043546D12
	8 m	EDP	EA Amphenol 7-pol.	High Flex Leder	7S4SH087043546D12
ABITIG® 18F	4 m	EDP	EA Amphenol 7-pol.	Standard	7S4FK047043546D12
	8 m	EDP	EA Amphenol 7-pol.	Standard	7S4FK087043546D12
	4 m	EDP	EA Amphenol 7-pol.	High Flex Leder	7S4FH047043546D12
	8 m	EDP	EA Amphenol 7-pol.	High Flex Leder	7S4FH087043546D12
ABITIG® 20	4 m	EDP	EA Amphenol 7-pol.	Standard	7S5SK047043546D12
	8 m	EDP	EA Amphenol 7-pol.	Standard	7S5SK087043546D12
	4 m	EDP	EA Amphenol 7-pol.	High Flex Leder	7S5SH047043546D12
	8 m	EDP	EA Amphenol 7-pol.	High Flex Leder	7S5SH087043546D12
ABITIG® 20F	4 m	EDP	EA Amphenol 7-pol.	Standard	7S5FK047043546D12
	8 m	EDP	EA Amphenol 7-pol.	Standard	7S5FK087043546D12
	4 m	EDP	EA Amphenol 7-pol.	High Flex Leder	7S5FH047043546D12
	8 m	EDP	EA Amphenol 7-pol.	High Flex Leder	7S5FH087043546D12

Technische Änderungen vorbehalten • Verkaufspreise = unverbindliche Preisempfehlung - Angebot freibleibend • © Copyright

ABITIG®-Brennerpreisliste

passend für WIG-Stromquellen des Fabrikates „kempfi“

Brennertyp	Länge	Schalterfunktion	maschinenseitiger Anschluss	Schlauchpaketausführung	Bestellnummer
ABITIG® 12-1	4 m	EDP	EA Amphenol 7-pol.	Standard	7S6SK047043546D12
	8 m	EDP	EA Amphenol 7-pol.	Standard	7S6SK087043546D12
	4 m	EDP	EA Amphenol 7-pol.	High Flex Leder	7S6SH047043546D12
	8 m	EDP	EA Amphenol 7-pol.	High Flex Leder	7S6SH087043546D12

ABITIG® 18SC	4 m	EDP	EA Amphenol 7-pol.	Standard	7S7SK047043546D12
	8 m	EDP	EA Amphenol 7-pol.	Standard	7S7SK087043546D12
	4 m	EDP	EA Amphenol 7-pol.	High Flex Leder	7S7SH047043546D12
	8 m	EDP	EA Amphenol 7-pol.	High Flex Leder	7S7SH087043546D12

ABITIG® 24W	4 m	EDP	EA Amphenol 7-pol.	Standard	7S9SK047043546D12
	8 m	EDP	EA Amphenol 7-pol.	Standard	7S9SK087043546D12
	4 m	EDP	EA Amphenol 7-pol.	High Flex Leder	7S9SH047043546D12
	8 m	EDP	EA Amphenol 7-pol.	High Flex Leder	7S9SH087043546D12

ABITIG® 450W	4 m	EDP	EA Amphenol 7-pol.	Standard	7T5SK047043546D12
	8 m	EDP	EA Amphenol 7-pol.	Standard	7T5SK087043546D12
	4 m	EDP	EA Amphenol 7-pol.	High Flex Leder	7T5SH047043546D12
	8 m	EDP	EA Amphenol 7-pol.	High Flex Leder	7T5SH087043546D12

ABITIG® 260W	4 m	EDP	EA Amphenol 7-pol.	Standard	7T7SK047043546D12
	8 m	EDP	EA Amphenol 7-pol.	Standard	7T7SK087043546D12
	4 m	EDP	EA Amphenol 7-pol.	High Flex Leder	7T7SH047043546D12
	8 m	EDP	EA Amphenol 7-pol.	High Flex Leder	7T7SH087043546D12

ABITIG® 450W SC	4 m	EDP	EA Amphenol 7-pol.	Standard	
	8 m	EDP	EA Amphenol 7-pol.	Standard	
	4 m	EDP	EA Amphenol 7-pol.	High Flex Leder	7T8SH047043546D12
	8 m	EDP	EA Amphenol 7-pol.	High Flex Leder	7T8SH087043546D12

ABITIG®-Brennerpreisliste

passend für WIG-Stromquellen des Fabrikates „kemppi“ Up/Down

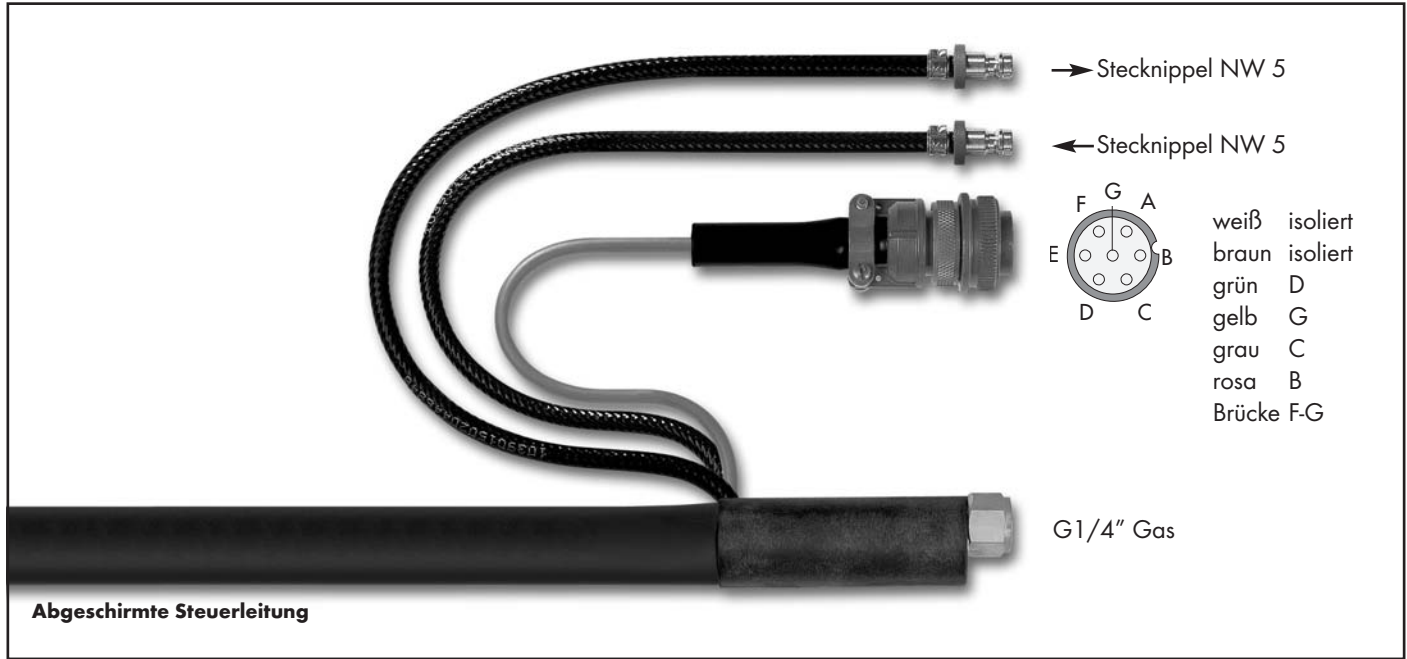

Brennertyp	Länge	Schalterfunktion	maschinenseitiger Anschluss	Schlauchpaketausführung	Bestellnummer
ABITIG® 18	4 m	UD	EA Amphenol 7-pol.	Standard	7S4SK047153532C12
	8 m	UD	EA Amphenol 7-pol.	Standard	7S4SK087153532C12
	4 m	UD	EA Amphenol 7-pol.	High Flex Leder	7S4SH047153532C12
	8 m	UD	EA Amphenol 7-pol.	High Flex Leder	7S4SH087153532C12
ABITIG® 18F	4 m	UD	EA Amphenol 7-pol.	Standard	7S4FK047153532C12
	8 m	UD	EA Amphenol 7-pol.	Standard	7S4FK087153532C12
	4 m	UD	EA Amphenol 7-pol.	High Flex Leder	7S4FH047153532C12
	8 m	UD	EA Amphenol 7-pol.	High Flex Leder	7S4FH087153532C12
ABITIG® 20	4 m	UD	EA Amphenol 7-pol.	Standard	7S5SK047153532C12
	8 m	UD	EA Amphenol 7-pol.	Standard	7S5SK087153532C12
	4 m	UD	EA Amphenol 7-pol.	High Flex Leder	7S5SH047153532C12
	8 m	UD	EA Amphenol 7-pol.	High Flex Leder	7S5SH087153532C12
ABITIG® 20F	4 m	UD	EA Amphenol 7-pol.	Standard	7S5FK047153532C12
	8 m	UD	EA Amphenol 7-pol.	Standard	7S5FK087153532C12
	4 m	UD	EA Amphenol 7-pol.	High Flex Leder	7S5FH047153532C12
	8 m	UD	EA Amphenol 7-pol.	High Flex Leder	7S5FH087153532C12

Technische Änderungen vorbehalten • Verkaufspreise = unverbindliche Preisempfehlung - Angebot freibleibend • © Copyright

ABITIG®-Brennerpreisliste

passend für WIG-Stromquellen des Fabrikates „kemppi“ Up/Down

Brennertyp	Länge	Schalterfunktion	maschinenseitiger Anschluss	Schlauchpaketausführung	Bestellnummer
ABITIG® 12-1	4 m	UD	EA Amphenol 7-pol.	Standard	7S6SK047153532C12
	8 m	UD	EA Amphenol 7-pol.	Standard	7S6SK087153532C12
	4 m	UD	EA Amphenol 7-pol.	High Flex Leder	7S6SH047153532C12
	8 m	UD	EA Amphenol 7-pol.	High Flex Leder	7S6SH087153532C12
ABITIG® 18SC	4 m	UD	EA Amphenol 7-pol.	Standard	7S7SK047153532C12
	8 m	UD	EA Amphenol 7-pol.	Standard	7S7SK087153532C12
	4 m	UD	EA Amphenol 7-pol.	High Flex Leder	7S7SH047153532C12
	8 m	UD	EA Amphenol 7-pol.	High Flex Leder	7S7SH087153532C12
ABITIG® 24W	4 m	UD	EA Amphenol 7-pol.	Standard	7S9SK047153532C12
	8 m	UD	EA Amphenol 7-pol.	Standard	7S9SK087153532C12
	4 m	UD	EA Amphenol 7-pol.	High Flex Leder	7S9SH047153532C12
	8 m	UD	EA Amphenol 7-pol.	High Flex Leder	7S9SH087153532C12
ABITIG® 450W	4 m	UD	EA Amphenol 7-pol.	Standard	7T5SK047153532C12
	8 m	UD	EA Amphenol 7-pol.	Standard	7T5SK087153532C12
	4 m	UD	EA Amphenol 7-pol.	High Flex Leder	7T5SH047153532C12
	8 m	UD	EA Amphenol 7-pol.	High Flex Leder	7T5SH087153532C12
ABITIG® 260W	4 m	UD	EA Amphenol 7-pol.	Standard	7T7SK047153532C12
	8 m	UD	EA Amphenol 7-pol.	Standard	7T7SK087153532C12
	4 m	UD	EA Amphenol 7-pol.	High Flex Leder	7T7SH047153532C12
	8 m	UD	EA Amphenol 7-pol.	High Flex Leder	7T7SH087153532C12
ABITIG® 450W SC	4 m	UD	EA Amphenol 7-pol.	Standard	
	8 m	UD	EA Amphenol 7-pol.	Standard	
	4 m	UD	EA Amphenol 7-pol.	High Flex Leder	7T8SH047153532C12
	8 m	UD	EA Amphenol 7-pol.	High Flex Leder	7T8SH087153532C12

ABITIG®-Brennerpreisliste

passend für WIG-Stromquellen des Fabrikates „kjellberg“



Brennertyp	Länge	Schalterfunktion	maschinenseitiger Anschluss	Schlauchpaketausführung	Bestellnummer
ABITIG® 9	4 m	ED	BSB 10-25 Tuchel 5-pol.	Standard	7S1SK043012226A06
	8 m	ED	BSB 10-25 Tuchel 5-pol.	Standard	7S1SK083012226A06
	4 m	ED	BSB 10-25 Tuchel 5-pol.	High Flex Leder	7S1SH043012226A06
	8 m	ED	BSB 10-25 Tuchel 5-pol.	High Flex Leder	7S1SH083012226A06

ABITIG® 9F	4 m	ED	BSB 10-25 Tuchel 5-pol.	Standard	7S1FK043012226A06
	8 m	ED	BSB 10-25 Tuchel 5-pol.	Standard	7S1FK083012226A06
	4 m	ED	BSB 10-25 Tuchel 5-pol.	High Flex Leder	7S1FH043012226A06
	8 m	ED	BSB 10-25 Tuchel 5-pol.	High Flex Leder	7S1FH083012226A06

ABITIG® 17	4 m	ED	BSB 10-25 Tuchel 5-pol.	Standard	7S2SK043012226A06
	8 m	ED	BSB 10-25 Tuchel 5-pol.	Standard	7S2SK083012226A06
	4 m	ED	BSB 10-25 Tuchel 5-pol.	High Flex Leder	7S2SH043012226A06
	8 m	ED	BSB 10-25 Tuchel 5-pol.	High Flex Leder	7S2SH083012226A06

ABITIG® 17F	4 m	ED	BSB 10-25 Tuchel 5-pol.	Standard	7S2FK043012226A06
	8 m	ED	BSB 10-25 Tuchel 5-pol.	Standard	7S2FK083012226A06
	4 m	ED	BSB 10-25 Tuchel 5-pol.	High Flex Leder	7S2FH043012226A06
	8 m	ED	BSB 10-25 Tuchel 5-pol.	High Flex Leder	7S2FH083012226A06

Technische Änderungen vorbehalten • Verkaufspreise = unverbindliche Preisempfehlung - Angebot freibleibend • © Copyright

ABITIG®-Brennerpreisliste

passend für WIG-Stromquellen des Fabrikates „kjellberg“



Brennertyp	Länge	Schalterfunktion	maschinenseitiger Anschluss	Schlauchpaketausführung	Bestellnummer
ABITIG® 9	4 m	ED	BSB 35-50 Tuchel 5-pol.	Standard	7S1SK043010026A06
	8 m	ED	BSB 35-50 Tuchel 5-pol.	Standard	7S1SK083010026A06
	4 m	ED	BSB 35-50 Tuchel 5-pol.	High Flex Leder	7S1SH043010026A06
	8 m	ED	BSB 35-50 Tuchel 5-pol.	High Flex Leder	7S1SH083010026A06

ABITIG® 9F	4 m	ED	BSB 35-50 Tuchel 5-pol.	Standard	7S1FK043010026A06
	8 m	ED	BSB 35-50 Tuchel 5-pol.	Standard	7S1FK083010026A06
	4 m	ED	BSB 35-50 Tuchel 5-pol.	High Flex Leder	7S1FH043010026A06
	8 m	ED	BSB 35-50 Tuchel 5-pol.	High Flex Leder	7S1FH083010026A06

ABITIG® 17	4 m	ED	BSB 35-50 Tuchel 5-pol.	Standard	7S2SK043010026A06
	8 m	ED	BSB 35-50 Tuchel 5-pol.	Standard	7S2SK083010026A06
	4 m	ED	BSB 35-50 Tuchel 5-pol.	High Flex Leder	7S2SH043010026A06
	8 m	ED	BSB 35-50 Tuchel 5-pol.	High Flex Leder	7S2SH083010026A06

ABITIG® 17F	4 m	ED	BSB 35-50 Tuchel 5-pol.	Standard	7S2FK043010026A06
	8 m	ED	BSB 35-50 Tuchel 5-pol.	Standard	7S2FK083010026A06
	4 m	ED	BSB 35-50 Tuchel 5-pol.	High Flex Leder	7S2FH043010026A06
	8 m	ED	BSB 35-50 Tuchel 5-pol.	High Flex Leder	7S2FH083010026A06

Technische Änderungen vorbehalten • Verkaufspreise = unverbindliche Preisempfehlung - Angebot freibleibend • © Copyright

ABITIG®-Brennerpreisliste

passend für WIG-Stromquellen des Fabrikates „kjellberg“

Brennertyp	Länge	Schalterfunktion	maschinenseitiger Anschluss	Schlauchpaketausführung	Bestellnummer
ABITIG® 26	4 m	ED	BSB 35-50 Tuchel 5-pol.	Standard	7S3SK043010026A06
	8 m	ED	BSB 35-50 Tuchel 5-pol.	Standard	7S3SK083010026A06
	4 m	ED	BSB 35-50 Tuchel 5-pol.	High Flex Leder	7S3SH043010026A06
	8 m	ED	BSB 35-50 Tuchel 5-pol.	High Flex Leder	7S3SH083010026A06

ABITIG® 26F	4 m	ED	BSB 35-50 Tuchel 5-pol.	Standard	7S3FK043010026A06
	8 m	ED	BSB 35-50 Tuchel 5-pol.	Standard	7S3FK083010026A06
	4 m	ED	BSB 35-50 Tuchel 5-pol.	High Flex Leder	7S3FH043010026A06
	8 m	ED	BSB 35-50 Tuchel 5-pol.	High Flex Leder	7S3FH083010026A06

ABITIG® 24G	4 m	ED	BSB 35-50 Tuchel 5-pol.	Standard	7S8SK043010026A06
	8 m	ED	BSB 35-50 Tuchel 5-pol.	Standard	7S8SK083010026A06
	4 m	ED	BSB 35-50 Tuchel 5-pol.	High Flex Leder	7S8SH043010026A06
	8 m	ED	BSB 35-50 Tuchel 5-pol.	High Flex Leder	7S8SH083010026A06

ABITIG® 200	4 m	ED	BSB 35-50 Tuchel 5-pol.	Standard	7T4SK043010026A06
	8 m	ED	BSB 35-50 Tuchel 5-pol.	Standard	7T4SK083010026A06
	4 m	ED	BSB 35-50 Tuchel 5-pol.	High Flex Leder	7T4SH043010026A06
	8 m	ED	BSB 35-50 Tuchel 5-pol.	High Flex Leder	7T4SH083010026A06

ABITIG® 200F	4 m	ED	BSB 35-50 Tuchel 5-pol.	Standard	7T4FK043010026A06
	8 m	ED	BSB 35-50 Tuchel 5-pol.	Standard	7T4FK083010026A06
	4 m	ED	BSB 35-50 Tuchel 5-pol.	High Flex Leder	7T4FH043010026A06
	8 m	ED	BSB 35-50 Tuchel 5-pol.	High Flex Leder	7T4FH083010026A06

ABITIG® 150	4 m	ED	BSB 35-50 Tuchel 5-pol.	Standard	7T6SK043010026A06
	8 m	ED	BSB 35-50 Tuchel 5-pol.	Standard	7T6SK083010026A06
	4 m	ED	BSB 35-50 Tuchel 5-pol.	High Flex Leder	7T6SH043010026A06
	8 m	ED	BSB 35-50 Tuchel 5-pol.	High Flex Leder	7T6SH083010026A06

ABITIG® 150F	4 m	ED	BSB 35-50 Tuchel 5-pol.	Standard	7T6FK043010026A06
	8 m	ED	BSB 35-50 Tuchel 5-pol.	Standard	7T6FK083010026A06
	4 m	ED	BSB 35-50 Tuchel 5-pol.	High Flex Leder	7T6FH043010026A06
	8 m	ED	BSB 35-50 Tuchel 5-pol.	High Flex Leder	7T6FH083010026A06

ABITIG®-Brennerpreisliste

passend für WIG-Stromquellen des Fabrikates „kjellberg“



Brennertyp	Länge	Schalterfunktion	maschinenseitiger Anschluss	Schlauchpaketausführung	Bestellnummer
ABITIG® 9	4 m	ED	BSB 10-25 Tuchel 3-pol.	Standard	7S1SK043012213B06
	8 m	ED	BSB 10-25 Tuchel 3-pol.	Standard	7S1SK083012213B06
	4 m	ED	BSB 10-25 Tuchel 3-pol.	High Flex Leder	7S1SH043012213B06
	8 m	ED	BSB 10-25 Tuchel 3-pol.	High Flex Leder	7S1SH083012213B06

ABITIG® 9F	4 m	ED	BSB 10-25 Tuchel 3-pol.	Standard	7S1FK043012213B06
	8 m	ED	BSB 10-25 Tuchel 3-pol.	Standard	7S1FK083012213B06
	4 m	ED	BSB 10-25 Tuchel 3-pol.	High Flex Leder	7S1FH043012213B06
	8 m	ED	BSB 10-25 Tuchel 3-pol.	High Flex Leder	7S1FH083012213B06

ABITIG® 17	4 m	ED	BSB 10-25 Tuchel 3-pol.	Standard	7S2SK043012213B06
	8 m	ED	BSB 10-25 Tuchel 3-pol.	Standard	7S2SK083012213B06
	4 m	ED	BSB 10-25 Tuchel 3-pol.	High Flex Leder	7S2SH043012213B06
	8 m	ED	BSB 10-25 Tuchel 3-pol.	High Flex Leder	7S2SH083012213B06

ABITIG® 17F	4 m	ED	BSB 10-25 Tuchel 3-pol.	Standard	7S2FK043012213B06
	8 m	ED	BSB 10-25 Tuchel 3-pol.	Standard	7S2FK083012213B06
	4 m	ED	BSB 10-25 Tuchel 3-pol.	High Flex Leder	7S2FH043012213B06
	8 m	ED	BSB 10-25 Tuchel 3-pol.	High Flex Leder	7S2FH083012213B06

Technische Änderungen vorbehalten • Verkaufspreise = unverbindliche Preisempfehlung - Angebot freibleibend • © Copyright

ABITIG®-Brennerpreisliste

passend für WIG-Stromquellen des Fabrikates „kjellberg“



Brennertyp	Länge	Schalterfunktion	maschinenseitiger Anschluss	Schlauchpaketausführung	Bestellnummer
ABITIG® 9	4 m	ED	BSB 35-50 Tuchel 3-pol.	Standard	7S1SK043010013B06
	8 m	ED	BSB 35-50 Tuchel 3-pol.	Standard	7S1SK083010013B06
	4 m	ED	BSB 35-50 Tuchel 3-pol.	High Flex Leder	7S1SH043010013B06
	8 m	ED	BSB 35-50 Tuchel 3-pol.	High Flex Leder	7S1SH083010013B06
ABITIG® 9F	4 m	ED	BSB 35-50 Tuchel 3-pol.	Standard	7S1FK043010013B06
	8 m	ED	BSB 35-50 Tuchel 3-pol.	Standard	7S1FK083010013B06
	4 m	ED	BSB 35-50 Tuchel 3-pol.	High Flex Leder	7S1FH043010013B06
	8 m	ED	BSB 35-50 Tuchel 3-pol.	High Flex Leder	7S1FH083010013B06
ABITIG® 17	4 m	ED	BSB 35-50 Tuchel 3-pol.	Standard	7S2SK043010013B06
	8 m	ED	BSB 35-50 Tuchel 3-pol.	Standard	7S2SK083010013B06
	4 m	ED	BSB 35-50 Tuchel 3-pol.	High Flex Leder	7S2SH043010013B06
	8 m	ED	BSB 35-50 Tuchel 3-pol.	High Flex Leder	7S2SH083010013B06
ABITIG® 17F	4 m	ED	BSB 35-50 Tuchel 3-pol.	Standard	7S2FK043010013B06
	8 m	ED	BSB 35-50 Tuchel 3-pol.	Standard	7S2FK083010013B06
	4 m	ED	BSB 35-50 Tuchel 3-pol.	High Flex Leder	7S2FH043010013B06
	8 m	ED	BSB 35-50 Tuchel 3-pol.	High Flex Leder	7S2FH083010013B06

Technische Änderungen vorbehalten • Verkaufspreise = unverbindliche Preisempfehlung - Angebot freibleibend • © Copyright

ABITIG®-Brennerpreisliste

passend für WIG-Stromquellen des Fabrikates „kjellberg“

Brennertyp	Länge	Schalterfunktion	maschinenseitiger Anschluss	Schlauchpaketausführung	Bestellnummer
ABITIG® 26	4 m	ED	BSB 35-50 Tuchel 3-pol.	Standard	7S3SK043010013B06
	8 m	ED	BSB 35-50 Tuchel 3-pol.	Standard	7S3SK083010013B06
	4 m	ED	BSB 35-50 Tuchel 3-pol.	High Flex Leder	7S3SH043010013B06
	8 m	ED	BSB 35-50 Tuchel 3-pol.	High Flex Leder	7S3SH083010013B06

ABITIG® 26F	4 m	ED	BSB 35-50 Tuchel 3-pol.	Standard	7S3FK043010013B06
	8 m	ED	BSB 35-50 Tuchel 3-pol.	Standard	7S3FK083010013B06
	4 m	ED	BSB 35-50 Tuchel 3-pol.	High Flex Leder	7S3FH043010013B06
	8 m	ED	BSB 35-50 Tuchel 3-pol.	High Flex Leder	7S3FH083010013B06

ABITIG® 24G	4 m	ED	BSB 35-50 Tuchel 3-pol.	Standard	7S8SK043010013B06
	8 m	ED	BSB 35-50 Tuchel 3-pol.	Standard	7S8SK083010013B06
	4 m	ED	BSB 35-50 Tuchel 3-pol.	High Flex Leder	7S8SH043010013B06
	8 m	ED	BSB 35-50 Tuchel 3-pol.	High Flex Leder	7S8SH083010013B06

ABITIG® 200	4 m	ED	BSB 35-50 Tuchel 3-pol.	Standard	7T4SK043010013B06
	8 m	ED	BSB 35-50 Tuchel 3-pol.	Standard	7T4SK083010013B06
	4 m	ED	BSB 35-50 Tuchel 3-pol.	High Flex Leder	7T4SH043010013B06
	8 m	ED	BSB 35-50 Tuchel 3-pol.	High Flex Leder	7T4SH083010013B06

ABITIG® 200F	4 m	ED	BSB 35-50 Tuchel 3-pol.	Standard	7T4FK043010013B06
	8 m	ED	BSB 35-50 Tuchel 3-pol.	Standard	7T4FK083010013B06
	4 m	ED	BSB 35-50 Tuchel 3-pol.	High Flex Leder	7T4FH043010013B06
	8 m	ED	BSB 35-50 Tuchel 3-pol.	High Flex Leder	7T4FH083010013B06

ABITIG® 150	4 m	ED	BSB 35-50 Tuchel 3-pol.	Standard	7T6SK043010013B06
	8 m	ED	BSB 35-50 Tuchel 3-pol.	Standard	7T6SK083010013B06
	4 m	ED	BSB 35-50 Tuchel 3-pol.	High Flex Leder	7T6SH043010013B06
	8 m	ED	BSB 35-50 Tuchel 3-pol.	High Flex Leder	7T6SH083010013B06

ABITIG® 150F	4 m	ED	BSB 35-50 Tuchel 3-pol.	Standard	7T6FK043010013B06
	8 m	ED	BSB 35-50 Tuchel 3-pol.	Standard	7T6FK083010013B06
	4 m	ED	BSB 35-50 Tuchel 3-pol.	High Flex Leder	7T6FH043010013B06
	8 m	ED	BSB 35-50 Tuchel 3-pol.	High Flex Leder	7T6FH083010013B06

ABITIG®-Brennerpreisliste

passend für WIG-Stromquellen des Fabrikates „kjellberg“



Brennertyp	Länge	Schalterfunktion	maschinenseitiger Anschluss	Schlauchpaketausführung	Bestellnummer
ABITIG® 9	4 m	DD	BSB 35-50 Tuchel - 5 pol.	Standard	7S1SK043020026B06
	8 m	DD	BSB 35-50 Tuchel - 5 pol.	Standard	7S1SK083020026B06
	4 m	DD	BSB 35-50 Tuchel - 5 pol.	High Flex Leder	7S1SH043020026B06
	8 m	DD	BSB 35-50 Tuchel - 5 pol.	High Flex Leder	7S1SH083020026B06

ABITIG® 9F	4 m	DD	BSB 35-50 Tuchel - 5 pol.	Standard	7S1FK043020026B06
	8 m	DD	BSB 35-50 Tuchel - 5 pol.	Standard	7S1FK083020026B06
	4 m	DD	BSB 35-50 Tuchel - 5 pol.	High Flex Leder	7S1FH043020026B06
	8 m	DD	BSB 35-50 Tuchel - 5 pol.	High Flex Leder	7S1FH083020026B06

ABITIG® 17	4 m	DD	BSB 35-50 Tuchel - 5 pol.	Standard	7S2SK043020026B06
	8 m	DD	BSB 35-50 Tuchel - 5 pol.	Standard	7S2SK083020026B06
	4 m	DD	BSB 35-50 Tuchel - 5 pol.	High Flex Leder	7S2SH043020026B06
	8 m	DD	BSB 35-50 Tuchel - 5 pol.	High Flex Leder	7S2SH083020026B06

ABITIG® 17F	4 m	DD	BSB 35-50 Tuchel - 5 pol.	Standard	7S2FK043020026B06
	8 m	DD	BSB 35-50 Tuchel - 5 pol.	Standard	7S2FK083020026B06
	4 m	DD	BSB 35-50 Tuchel - 5 pol.	High Flex Leder	7S2FH043020026B06
	8 m	DD	BSB 35-50 Tuchel - 5 pol.	High Flex Leder	7S2FH083020026B06

Technische Änderungen vorbehalten • Verkaufspreise = unverbindliche Preisempfehlung - Angebot freibleibend • © Copyright

ABITIG®-Brennerpreisliste

passend für WIG-Stromquellen des Fabrikates „kjellberg“

Brennertyp	Länge	Schalterfunktion	maschinenseitiger Anschluss	Schlauchpaketausführung	Bestellnummer
ABITIG® 26	4 m	DD	BSB 35-50 Tuchel 5-pol.	Standard	7S3SK043020026B06
	8 m	DD	BSB 35-50 Tuchel 5-pol.	Standard	7S3SK083020026B06
	4 m	DD	BSB 35-50 Tuchel 5-pol.	High Flex Leder	7S3SH043020026B06
	8 m	DD	BSB 35-50 Tuchel 5-pol.	High Flex Leder	7S3SH083020026B06
ABITIG® 26F	4 m	DD	BSB 35-50 Tuchel 5-pol.	Standard	7S3FK043020026B06
	8 m	DD	BSB 35-50 Tuchel 5-pol.	Standard	7S3FK083020026B06
	4 m	DD	BSB 35-50 Tuchel 5-pol.	High Flex Leder	7S3FH043020026B06
	8 m	DD	BSB 35-50 Tuchel 5-pol.	High Flex Leder	7S3FH083020026B06
ABITIG® 24G	4 m	DD	BSB 35-50 Tuchel 5-pol.	Standard	7S8SK043020026B06
	8 m	DD	BSB 35-50 Tuchel 5-pol.	Standard	7S8SK083020026B06
	4 m	DD	BSB 35-50 Tuchel 5-pol.	High Flex Leder	7S8SH043020026B06
	8 m	DD	BSB 35-50 Tuchel 5-pol.	High Flex Leder	7S8SH083020026B06
ABITIG® 200	4 m	DD	BSB 35-50 Tuchel 5-pol.	Standard	7T4SK043020026B06
	8 m	DD	BSB 35-50 Tuchel 5-pol.	Standard	7T4SK083020026B06
	4 m	DD	BSB 35-50 Tuchel 5-pol.	High Flex Leder	7T4SH043020026B06
	8 m	DD	BSB 35-50 Tuchel 5-pol.	High Flex Leder	7T4SH083020026B06
ABITIG® 200F	4 m	DD	BSB 35-50 Tuchel 5-pol.	Standard	7T4FK043020026B06
	8 m	DD	BSB 35-50 Tuchel 5-pol.	Standard	7T4FK083020026B06
	4 m	DD	BSB 35-50 Tuchel 5-pol.	High Flex Leder	7T4FH043020026B06
	8 m	DD	BSB 35-50 Tuchel 5-pol.	High Flex Leder	7T4FH083020026B06
ABITIG® 150	4 m	DD	BSB 35-50 Tuchel 5-pol.	Standard	7T6SK043020026B06
	8 m	DD	BSB 35-50 Tuchel 5-pol.	Standard	7T6SK083020026B06
	4 m	DD	BSB 35-50 Tuchel 5-pol.	High Flex Leder	7T6SH043020026B06
	8 m	DD	BSB 35-50 Tuchel 5-pol.	High Flex Leder	7T6SH083020026B06
ABITIG® 150F	4 m	DD	BSB 35-50 Tuchel 5-pol.	Standard	7T6FK043020026B06
	8 m	DD	BSB 35-50 Tuchel 5-pol.	Standard	7T6FK083020026B06
	4 m	DD	BSB 35-50 Tuchel 5-pol.	High Flex Leder	7T6FH043020026B06
	8 m	DD	BSB 35-50 Tuchel 5-pol.	High Flex Leder	7T6FH083020026B06

ABITIG®-Brennerpreisliste

passend für WIG-Stromquellen des Fabrikates „kjellberg“



Brennertyp	Länge	Schalterfunktion	maschinenseitiger Anschluss	Schlauchpaketausführung	Bestellnummer
ABITIG® 9	4 m	EDP	BSB 10-25 Tuchel 7-pol.	Standard	7S1SK046042227A06
	8 m	EDP	BSB 10-25 Tuchel 7-pol.	Standard	7S1SK086042227A06
	4 m	EDP	BSB 10-25 Tuchel 7-pol.	High Flex Leder	7S1SH046042227A06
	8 m	EDP	BSB 10-25 Tuchel 7-pol.	High Flex Leder	7S1SH086042227A06
ABITIG® 9F	4 m	EDP	BSB 10-25 Tuchel 7-pol.	Standard	7S1FK046042227A06
	8 m	EDP	BSB 10-25 Tuchel 7-pol.	Standard	7S1FK086042227A06
	4 m	EDP	BSB 10-25 Tuchel 7-pol.	High Flex Leder	7S1FH046042227A06
	8 m	EDP	BSB 10-25 Tuchel 7-pol.	High Flex Leder	7S1FH086042227A06
ABITIG® 17	4 m	EDP	BSB 10-25 Tuchel 7-pol.	Standard	7S2SK046042227A06
	8 m	EDP	BSB 10-25 Tuchel 7-pol.	Standard	7S2SK086042227A06
	4 m	EDP	BSB 10-25 Tuchel 7-pol.	High Flex Leder	7S2SH046042227A06
	8 m	EDP	BSB 10-25 Tuchel 7-pol.	High Flex Leder	7S2SH086042227A06
ABITIG® 17F	4 m	EDP	BSB 10-25 Tuchel 7-pol.	Standard	7S2FK046042227A06
	8 m	EDP	BSB 10-25 Tuchel 7-pol.	Standard	7S2FK086042227A06
	4 m	EDP	BSB 10-25 Tuchel 7-pol.	High Flex Leder	7S2FH046042227A06
	8 m	EDP	BSB 10-25 Tuchel 7-pol.	High Flex Leder	7S2FH086042227A06

Technische Änderungen vorbehalten • Verkaufspreise = unverbindliche Preisempfehlung - Angebot freibleibend • © Copyright

ABITIG®-Brennerpreisliste

passend für WIG-Stromquellen des Fabrikates „kjellberg“

Brennertyp	Länge	Schalterfunktion	maschinenseitiger Anschluss	Schlauchpaketausführung	Bestellnummer
------------	-------	------------------	-----------------------------	-------------------------	---------------

ABITIG® 26

ABITIG® 26F

ABITIG® 24G	4 m	EDP	BSB 10-25 Tuchel 7-pol.	Standard	7S8SK046042227A06
	8 m	EDP	BSB 10-25 Tuchel 7-pol.	Standard	7S8SK086042227A06
	4 m	EDP	BSB 10-25 Tuchel 7-pol.	High Flex Leder	7S8SH046042227A06
	8 m	EDP	BSB 10-25 Tuchel 7-pol.	High Flex Leder	7S8SH086042227A06

ABITIG® 200

ABITIG® 200F

ABITIG® 150	4 m	EDP	BSB 10-25 Tuchel 7-pol.	Standard	7T6SK046042227A06
	8 m	EDP	BSB 10-25 Tuchel 7-pol.	Standard	7T6SK086042227A06
	4 m	EDP	BSB 10-25 Tuchel 7-pol.	High Flex Leder	7T6SH046042227A06
	8 m	EDP	BSB 10-25 Tuchel 7-pol.	High Flex Leder	7T6SH086042227A06

ABITIG® 150F	4 m	EDP	BSB 10-25 Tuchel 7-pol.	Standard	7T6FK046042227A06
	8 m	EDP	BSB 10-25 Tuchel 7-pol.	Standard	7T6FK086042227A06
	4 m	EDP	BSB 10-25 Tuchel 7-pol.	High Flex Leder	7T6FH046042227A06
	8 m	EDP	BSB 10-25 Tuchel 7-pol.	High Flex Leder	7T6FH086042227A06

ABITIG®-Brennerpreisliste

passend für WIG-Stromquellen des Fabrikates „kjellberg“



Brennertyp	Länge	Schalterfunktion	maschinenseitiger Anschluss	Schlauchpaketausführung	Bestellnummer
ABITIG® 9	4 m	EDP	BSB 35-50 Tuchel 7-pol.	Standard	7S1SK046040027A06
	8 m	EDP	BSB 35-50 Tuchel 7-pol.	Standard	7S1SK086040027A06
	4 m	EDP	BSB 35-50 Tuchel 7-pol.	High Flex Leder	7S1SH046040027A06
	8 m	EDP	BSB 35-50 Tuchel 7-pol.	High Flex Leder	7S1SH086040027A06
ABITIG® 9F	4 m	EDP	BSB 35-50 Tuchel 7-pol.	Standard	7S1FK046040027A06
	8 m	EDP	BSB 35-50 Tuchel 7-pol.	Standard	7S1FK086040027A06
	4 m	EDP	BSB 35-50 Tuchel 7-pol.	High Flex Leder	7S1FH046040027A06
	8 m	EDP	BSB 35-50 Tuchel 7-pol.	High Flex Leder	7S1FH086040027A06
ABITIG® 17	4 m	EDP	BSB 35-50 Tuchel 7-pol.	Standard	7S2SK046040027A06
	8 m	EDP	BSB 35-50 Tuchel 7-pol.	Standard	7S2SK086040027A06
	4 m	EDP	BSB 35-50 Tuchel 7-pol.	High Flex Leder	7S2SH046040027A06
	8 m	EDP	BSB 35-50 Tuchel 7-pol.	High Flex Leder	7S2SH086040027A06
ABITIG® 17F	4 m	EDP	BSB 35-50 Tuchel 7-pol.	Standard	7S2FK046040027A06
	8 m	EDP	BSB 35-50 Tuchel 7-pol.	Standard	7S2FK086040027A06
	4 m	EDP	BSB 35-50 Tuchel 7-pol.	High Flex Leder	7S2FH046040027A06
	8 m	EDP	BSB 35-50 Tuchel 7-pol.	High Flex Leder	7S2FH086040027A06

Technische Änderungen vorbehalten • Verkaufspreise = unverbindliche Preisempfehlung - Angebot freibleibend • © Copyright

ABITIG®-Brennerpreisliste

passend für WIG-Stromquellen des Fabrikates „kjellberg“

Brennertyp	Länge	Schalterfunktion	maschinenseitiger Anschluss	Schlauchpaketausführung	Bestellnummer
ABITIG® 26	4 m	EDP	BSB 35-50 Tuchel 7-pol.	Standard	7S3SK046040027A06
	8 m	EDP	BSB 35-50 Tuchel 7-pol.	Standard	7S3SK086040027A06
	4 m	EDP	BSB 35-50 Tuchel 7-pol.	High Flex Leder	7S3SH046040027A06
	8 m	EDP	BSB 35-50 Tuchel 7-pol.	High Flex Leder	7S3SH086040027A06
ABITIG® 26F	4 m	EDP	BSB 35-50 Tuchel 7-pol.	Standard	7S3FK046040027A06
	8 m	EDP	BSB 35-50 Tuchel 7-pol.	Standard	7S3FK086040027A06
	4 m	EDP	BSB 35-50 Tuchel 7-pol.	High Flex Leder	7S3FH046040027A06
	8 m	EDP	BSB 35-50 Tuchel 7-pol.	High Flex Leder	7S3FH086040027A06
ABITIG® 24G	4 m	EDP	BSB 35-50 Tuchel 7-pol.	Standard	7S8SK046040027A06
	8 m	EDP	BSB 35-50 Tuchel 7-pol.	Standard	7S8SK086040027A06
	4 m	EDP	BSB 35-50 Tuchel 7-pol.	High Flex Leder	7S8SH046040027A06
	8 m	EDP	BSB 35-50 Tuchel 7-pol.	High Flex Leder	7S8SH086040027A06
ABITIG® 200	4 m	EDP	BSB 35-50 Tuchel 7-pol.	Standard	7T4SK046040027A06
	8 m	EDP	BSB 35-50 Tuchel 7-pol.	Standard	7T4SK086040027A06
	4 m	EDP	BSB 35-50 Tuchel 7-pol.	High Flex Leder	7T4SH046040027A06
	8 m	EDP	BSB 35-50 Tuchel 7-pol.	High Flex Leder	7T4SH086040027A06
ABITIG® 200F	4 m	EDP	BSB 35-50 Tuchel 7-pol.	Standard	7T4FK046040027A06
	8 m	EDP	BSB 35-50 Tuchel 7-pol.	Standard	7T4FK086040027A06
	4 m	EDP	BSB 35-50 Tuchel 7-pol.	High Flex Leder	7T4FH046040027A06
	8 m	EDP	BSB 35-50 Tuchel 7-pol.	High Flex Leder	7T4FH086040027A06
ABITIG® 150	4 m	EDP	BSB 35-50 Tuchel 7-pol.	Standard	7T6SK046040027A06
	8 m	EDP	BSB 35-50 Tuchel 7-pol.	Standard	7T6SK086040027A06
	4 m	EDP	BSB 35-50 Tuchel 7-pol.	High Flex Leder	7T6SH046040027A06
	8 m	EDP	BSB 35-50 Tuchel 7-pol.	High Flex Leder	7T6SH086040027A06
ABITIG® 150F	4 m	EDP	BSB 35-50 Tuchel 7-pol.	Standard	7T6FK046040027A06
	8 m	EDP	BSB 35-50 Tuchel 7-pol.	Standard	7T6FK086040027A06
	4 m	EDP	BSB 35-50 Tuchel 7-pol.	High Flex Leder	7T6FH046040027A06
	8 m	EDP	BSB 35-50 Tuchel 7-pol.	High Flex Leder	7T6FH086040027A06

ABITIG®-Brennerpreisliste

passend für WIG-Stromquellen des Fabrikates „kjellberg“

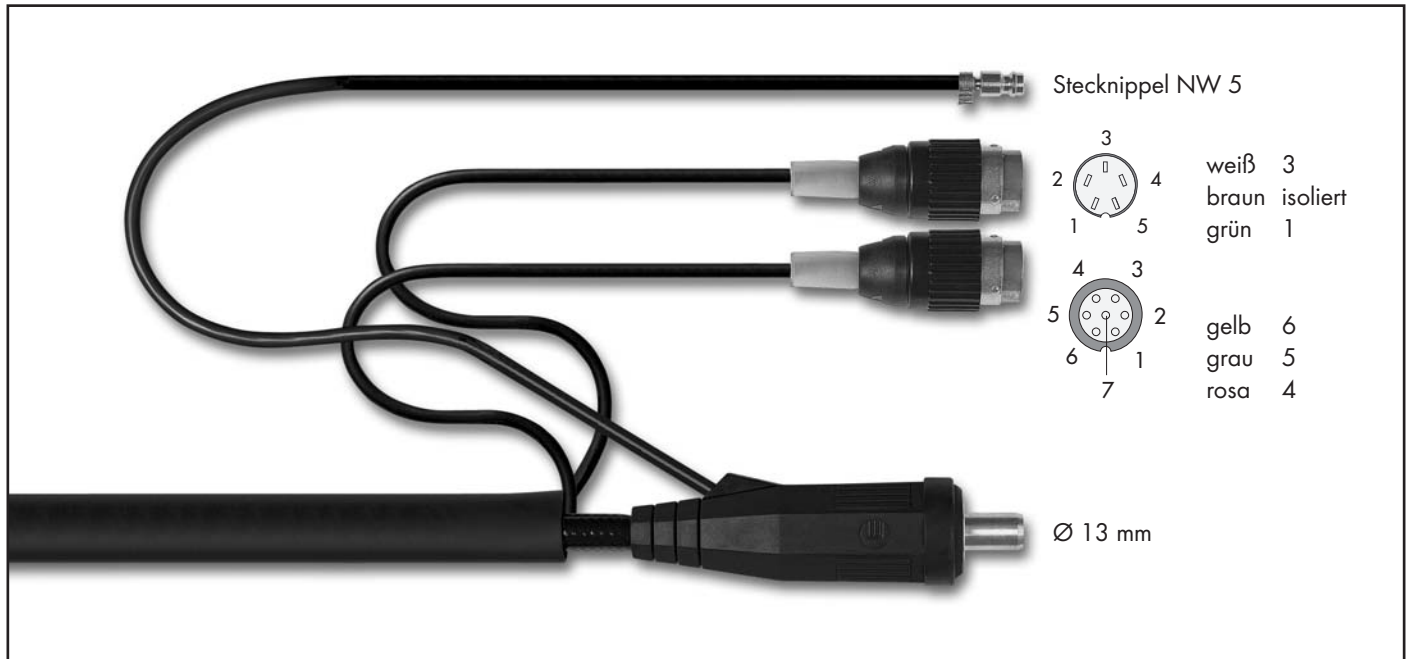

Brennertyp	Länge	Schalterfunktion	maschinenseitiger Anschluss	Schlauchpaketausführung	Bestellnummer
ABITIG® 9	4 m	EDP	BSB 35-50 Tuchel 5-pol./ 7-pol.	Standard	7S1SK046040042A06
	8 m	EDP	BSB 35-50 Tuchel 5-pol./ 7-pol.	Standard	7S1SK086040042A06
	4 m	EDP	BSB 35-50 Tuchel 5-pol./ 7-pol.	High Flex Leder	7S1SH046040042A06
	8 m	EDP	BSB 35-50 Tuchel 5-pol./ 7-pol.	High Flex Leder	7S1SH086040042A06
ABITIG® 9F	4 m	EDP	BSB 35-50 Tuchel 5-pol./ 7-pol.	Standard	7S1FK046040042A06
	8 m	EDP	BSB 35-50 Tuchel 5-pol./ 7-pol.	Standard	7S1FK086040042A06
	4 m	EDP	BSB 35-50 Tuchel 5-pol./ 7-pol.	High Flex Leder	7S1FH046040042A06
	8 m	EDP	BSB 35-50 Tuchel 5-pol./ 7-pol.	High Flex Leder	7S1FH086040042A06
ABITIG® 17	4 m	EDP	BSB 35-50 Tuchel 5-pol./ 7-pol.	Standard	7S2SK046040042A06
	8 m	EDP	BSB 35-50 Tuchel 5-pol./ 7-pol.	Standard	7S2SK086040042A06
	4 m	EDP	BSB 35-50 Tuchel 5-pol./ 7-pol.	High Flex Leder	7S2SH046040042A06
	8 m	EDP	BSB 35-50 Tuchel 5-pol./ 7-pol.	High Flex Leder	7S2SH086040042A06
ABITIG® 17F	4 m	EDP	BSB 35-50 Tuchel 5-pol./ 7-pol.	Standard	7S2FK046040042A06
	8 m	EDP	BSB 35-50 Tuchel 5-pol./ 7-pol.	Standard	7S2FK086040042A06
	4 m	EDP	BSB 35-50 Tuchel 5-pol./ 7-pol.	High Flex Leder	7S2FH046040042A06
	8 m	EDP	BSB 35-50 Tuchel 5-pol./ 7-pol.	High Flex Leder	7S2FH086040042A06

Technische Änderungen vorbehalten • Verkaufspreise = unverbindliche Preisempfehlung - Angebot freibleibend • © Copyright

ABITIG®-Brennerpreisliste

passend für WIG-Stromquellen des Fabrikates „kjellberg“

Brennertyp	Länge	Schalterfunktion	maschinenseitiger Anschluss	Schlauchpaketausführung	Bestellnummer
ABITIG® 26	4 m	EDP	BSB 35-50 Tuchel 5-pol./ 7-pol.	Standard	7S3SK046040042A06
	8 m	EDP	BSB 35-50 Tuchel 5-pol./ 7-pol.	Standard	7S3SK086040042A06
	4 m	EDP	BSB 35-50 Tuchel 5-pol./ 7-pol.	High Flex Leder	7S3SH046040042A06
	8 m	EDP	BSB 35-50 Tuchel 5-pol./ 7-pol.	High Flex Leder	7S3SH086040042A06
ABITIG® 26F	4 m	EDP	BSB 35-50 Tuchel 5-pol./ 7-pol.	Standard	7S3FK046040042A06
	8 m	EDP	BSB 35-50 Tuchel 5-pol./ 7-pol.	Standard	7S3FK086040042A06
	4 m	EDP	BSB 35-50 Tuchel 5-pol./ 7-pol.	High Flex Leder	7S3FH046040042A06
	8 m	EDP	BSB 35-50 Tuchel 5-pol./ 7-pol.	High Flex Leder	7S3FH086040042A06
ABITIG® 24G	4 m	EDP	BSB 35-50 Tuchel 5-pol./ 7-pol.	Standard	7S8SK046040042A06
	8 m	EDP	BSB 35-50 Tuchel 5-pol./ 7-pol.	Standard	7S8SK086040042A06
	4 m	EDP	BSB 35-50 Tuchel 5-pol./ 7-pol.	High Flex Leder	7S8SH046040042A06
	8 m	EDP	BSB 35-50 Tuchel 5-pol./ 7-pol.	High Flex Leder	7S8SH086040042A06
ABITIG® 200	4 m	EDP	BSB 35-50 Tuchel 5-pol./ 7-pol.	Standard	7T4SK046040042A06
	8 m	EDP	BSB 35-50 Tuchel 5-pol./ 7-pol.	Standard	7T4SK086040042A06
	4 m	EDP	BSB 35-50 Tuchel 5-pol./ 7-pol.	High Flex Leder	7T4SH046040042A06
	8 m	EDP	BSB 35-50 Tuchel 5-pol./ 7-pol.	High Flex Leder	7T4SH086040042A06
ABITIG® 200F	4 m	EDP	BSB 35-50 Tuchel 5-pol./ 7-pol.	Standard	7T4FK046040042A06
	8 m	EDP	BSB 35-50 Tuchel 5-pol./ 7-pol.	Standard	7T4FK086040042A06
	4 m	EDP	BSB 35-50 Tuchel 5-pol./ 7-pol.	High Flex Leder	7T4FH046040042A06
	8 m	EDP	BSB 35-50 Tuchel 5-pol./ 7-pol.	High Flex Leder	7T4FH086040042A06
ABITIG® 150	4 m	EDP	BSB 35-50 Tuchel 5-pol./ 7-pol.	Standard	7T6SK046040042A06
	8 m	EDP	BSB 35-50 Tuchel 5-pol./ 7-pol.	Standard	7T6SK086040042A06
	4 m	EDP	BSB 35-50 Tuchel 5-pol./ 7-pol.	High Flex Leder	7T6SH046040042A06
	8 m	EDP	BSB 35-50 Tuchel 5-pol./ 7-pol.	High Flex Leder	7T6SH086040042A06
ABITIG® 150F	4 m	EDP	BSB 35-50 Tuchel 5-pol./ 7-pol.	Standard	7T6FK046040042A06
	8 m	EDP	BSB 35-50 Tuchel 5-pol./ 7-pol.	Standard	7T6FK086040042A06
	4 m	EDP	BSB 35-50 Tuchel 5-pol./ 7-pol.	High Flex Leder	7T6FH046040042A06
	8 m	EDP	BSB 35-50 Tuchel 5-pol./ 7-pol.	High Flex Leder	7T6FH086040042A06

ABITIG®-Brennerpreisliste

passend für WIG-Stromquellen des Fabrikates „kjellberg“



Brennertyp	Länge	Schalterfunktion	maschinenseitiger Anschluss	Schlauchpaketausführung	Bestellnummer
ABITIG® 18	4 m	ED	BSB 35-50 Tuchel 5-pol.	Standard	7S4SK043010014A20
	8 m	ED	BSB 35-50 Tuchel 5-pol.	Standard	7S4SK083010014A20
	4 m	ED	BSB 35-50 Tuchel 5-pol.	High Flex Leder	7S4SH043010014A20
	8 m	ED	BSB 35-50 Tuchel 5-pol.	High Flex Leder	7S4SH083010014A20
ABITIG® 18F	4 m	ED	BSB 35-50 Tuchel 5-pol.	Standard	7S4FK043010014A20
	8 m	ED	BSB 35-50 Tuchel 5-pol.	Standard	7S4FK083010014A20
	4 m	ED	BSB 35-50 Tuchel 5-pol.	High Flex Leder	7S4FH043010014A20
	8 m	ED	BSB 35-50 Tuchel 5-pol.	High Flex Leder	7S4FH083010014A20
ABITIG® 20	4 m	ED	BSB 35-50 Tuchel 5-pol.	Standard	7S5SK043010014A20
	8 m	ED	BSB 35-50 Tuchel 5-pol.	Standard	7S5SK083010014A20
	4 m	ED	BSB 35-50 Tuchel 5-pol.	High Flex Leder	7S5SH043010014A20
	8 m	ED	BSB 35-50 Tuchel 5-pol.	High Flex Leder	7S5SH083010014A20
ABITIG® 20F	4 m	ED	BSB 35-50 Tuchel 5-pol.	Standard	7S5FK043010014A20
	8 m	ED	BSB 35-50 Tuchel 5-pol.	Standard	7S5FK083010014A20
	4 m	ED	BSB 35-50 Tuchel 5-pol.	High Flex Leder	7S5FH043010014A20
	8 m	ED	BSB 35-50 Tuchel 5-pol.	High Flex Leder	7S5FH083010014A20

Technische Änderungen vorbehalten • Verkaufspreise = unverbindliche Preisempfehlung - Angebot freibleibend • © Copyright

ABITIG®-Brennerpreisliste

passend für WIG-Stromquellen des Fabrikates „kjellberg“

Brennertyp	Länge	Schalterfunktion	maschinenseitiger Anschluss	Schlauchpaketausführung	Bestellnummer
ABITIG® 12-1	4 m	ED	BSB 35-50 Tuchel 5-pol.	Standard	7S6SK043010014A20
	8 m	ED	BSB 35-50 Tuchel 5-pol.	Standard	7S6SK083010014A20
	4 m	ED	BSB 35-50 Tuchel 5-pol.	High Flex Leder	7S6SH043010014A20
	8 m	ED	BSB 35-50 Tuchel 5-pol.	High Flex Leder	7S6SH083010014A20
<hr/>					
ABITIG® 18SC	4 m	ED	BSB 35-50 Tuchel 5-pol.	Standard	7S7SK043010014A20
	8 m	ED	BSB 35-50 Tuchel 5-pol.	Standard	7S7SK083010014A20
	4 m	ED	BSB 35-50 Tuchel 5-pol.	High Flex Leder	7S7SH043010014A20
	8 m	ED	BSB 35-50 Tuchel 5-pol.	High Flex Leder	7S7SH083010014A20
<hr/>					
ABITIG® 24W	4 m	ED	BSB 35-50 Tuchel 5-pol.	Standard	7S9SK043010014A20
	8 m	ED	BSB 35-50 Tuchel 5-pol.	Standard	7S9SK083010014A20
	4 m	ED	BSB 35-50 Tuchel 5-pol.	High Flex Leder	7S9SH043010014A20
	8 m	ED	BSB 35-50 Tuchel 5-pol.	High Flex Leder	7S9SH083010014A20
<hr/>					
ABITIG® 450W	4 m	ED	BSB 35-50 Tuchel 5-pol.	Standard	7T5SK043010114A20
	8 m	ED	BSB 35-50 Tuchel 5-pol.	Standard	7T5SK083010114A20
	4 m	ED	BSB 35-50 Tuchel 5-pol.	High Flex Leder	7T5SH043010114A20
	8 m	ED	BSB 35-50 Tuchel 5-pol.	High Flex Leder	7T5SH083010114A20
<hr/>					
ABITIG® 260W	4 m	ED	BSB 35-50 Tuchel 5-pol.	Standard	7T7SK043010114A20
	8 m	ED	BSB 35-50 Tuchel 5-pol.	Standard	7T7SK083010114A20
	4 m	ED	BSB 35-50 Tuchel 5-pol.	High Flex Leder	7T7SH043010114A20
	8 m	ED	BSB 35-50 Tuchel 5-pol.	High Flex Leder	7T7SH083010114A20
<hr/>					
ABITIG® 450W SC	4 m	ED	BSB 35-50 Tuchel 5-pol.	Standard	
	8 m	ED	BSB 35-50 Tuchel 5-pol.	Standard	
	4 m	ED	BSB 35-50 Tuchel 5-pol.	High Flex Leder	7T8SH043010114A20
	8 m	ED	BSB 35-50 Tuchel 5-pol.	High Flex Leder	7T8SH083010114A20

ABITIG®-Brennerpreisliste

passend für WIG-Stromquellen des Fabrikates „kjellberg“



Brennertyp	Länge	Schalterfunktion	maschinenseitiger Anschluss	Schlauchpaketausführung	Bestellnummer
ABITIG® 18	4 m	ED	BSB 35-50 Tuchel 3-pol.	Standard	7S4SK043010013B20
	8 m	ED	BSB 35-50 Tuchel 3-pol.	Standard	7S4SK083010013B20
	4 m	ED	BSB 35-50 Tuchel 3-pol.	High Flex Leder	7S4SH043010013B20
	8 m	ED	BSB 35-50 Tuchel 3-pol.	High Flex Leder	7S4SH083010013B20
ABITIG® 18F	4 m	ED	BSB 35-50 Tuchel 3-pol.	Standard	7S4FK043010013B20
	8 m	ED	BSB 35-50 Tuchel 3-pol.	Standard	7S4FK083010013B20
	4 m	ED	BSB 35-50 Tuchel 3-pol.	High Flex Leder	7S4FH043010013B20
	8 m	ED	BSB 35-50 Tuchel 3-pol.	High Flex Leder	7S4FH083010013B20
ABITIG® 20	4 m	ED	BSB 35-50 Tuchel 3-pol.	Standard	7S5SK043010013B20
	8 m	ED	BSB 35-50 Tuchel 3-pol.	Standard	7S5SK083010013B20
	4 m	ED	BSB 35-50 Tuchel 3-pol.	High Flex Leder	7S5SH043010013B20
	8 m	ED	BSB 35-50 Tuchel 3-pol.	High Flex Leder	7S5SH083010013B20
ABITIG® 20F	4 m	ED	BSB 35-50 Tuchel 3-pol.	Standard	7S5FK043010013B20
	8 m	ED	BSB 35-50 Tuchel 3-pol.	Standard	7S5FK083010013B20
	4 m	ED	BSB 35-50 Tuchel 3-pol.	High Flex Leder	7S5FH043010013B20
	8 m	ED	BSB 35-50 Tuchel 3-pol.	High Flex Leder	7S5FH083010013B20

Technische Änderungen vorbehalten • Verkaufspreise = unverbindliche Preisempfehlung - Angebot freibleibend • © Copyright

ABITIG®-Brennerpreisliste

passend für WIG-Stromquellen des Fabrikates „kjellberg“

Brennertyp	Länge	Schalterfunktion	maschinenseitiger Anschluss	Schlauchpaketausführung	Bestellnummer
ABITIG® 12-1	4 m	ED	BSB 35-50 Tuchel 3-pol.	Standard	7S6SK043010013B20
	8 m	ED	BSB 35-50 Tuchel 3-pol.	Standard	7S6SK083010013B20
	4 m	ED	BSB 35-50 Tuchel 3-pol.	High Flex Leder	7S6SH043010013B20
	8 m	ED	BSB 35-50 Tuchel 3-pol.	High Flex Leder	7S6SH083010013B20
<hr/>					
ABITIG® 18SC	4 m	ED	BSB 35-50 Tuchel 3-pol.	Standard	7S7SK043010013B20
	8 m	ED	BSB 35-50 Tuchel 3-pol.	Standard	7S7SK083010013B20
	4 m	ED	BSB 35-50 Tuchel 3-pol.	High Flex Leder	7S7SH043010013B20
	8 m	ED	BSB 35-50 Tuchel 3-pol.	High Flex Leder	7S7SH083010013B20
<hr/>					
ABITIG® 24W	4 m	ED	BSB 35-50 Tuchel 3-pol.	Standard	7S9SK043010013B20
	8 m	ED	BSB 35-50 Tuchel 3-pol.	Standard	7S9SK083010013B20
	4 m	ED	BSB 35-50 Tuchel 3-pol.	High Flex Leder	7S9SH043010013B20
	8 m	ED	BSB 35-50 Tuchel 3-pol.	High Flex Leder	7S9SH083010013B20
<hr/>					
ABITIG® 450W	4 m	ED	BSB 35-50 Tuchel 3-pol.	Standard	7T5SK043010113B20
	8 m	ED	BSB 35-50 Tuchel 3-pol.	Standard	7T5SK083010113B20
	4 m	ED	BSB 35-50 Tuchel 3-pol.	High Flex Leder	7T5SH043010113B20
	8 m	ED	BSB 35-50 Tuchel 3-pol.	High Flex Leder	7T5SH083010113B20
<hr/>					
ABITIG® 260W	4 m	ED	BSB 35-50 Tuchel 3-pol.	Standard	7T7SK043010113B20
	8 m	ED	BSB 35-50 Tuchel 3-pol.	Standard	7T7SK083010113B20
	4 m	ED	BSB 35-50 Tuchel 3-pol.	High Flex Leder	7T7SH043010113B20
	8 m	ED	BSB 35-50 Tuchel 3-pol.	High Flex Leder	7T7SH083010113B20
<hr/>					
ABITIG® 450W SC	4 m	ED	BSB 35-50 Tuchel 3-pol.	Standard	
	8 m	ED	BSB 35-50 Tuchel 3-pol.	Standard	
	4 m	ED	BSB 35-50 Tuchel 3-pol.	High Flex Leder	7T8SH043010113B20
	8 m	ED	BSB 35-50 Tuchel 3-pol.	High Flex Leder	7T8SH083010113B20

ABITIG®-Brennerpreisliste

passend für WIG-Stromquellen des Fabrikates „kjellberg“



Brennertyp	Länge	Schalterfunktion	maschinenseitiger Anschluss	Schlauchpaketausführung	Bestellnummer
ABITIG® 18	4 m	DD	BSB 35-50 Tuchel 5-pol.	Standard	7S4SK043020026C20
	8 m	DD	BSB 35-50 Tuchel 5-pol.	Standard	7S4SK083020026C20
	4 m	DD	BSB 35-50 Tuchel 5-pol.	High Flex Leder	7S4SH043020026C20
	8 m	DD	BSB 35-50 Tuchel 5-pol.	High Flex Leder	7S4SH083020026C20
ABITIG® 18F	4 m	DD	BSB 35-50 Tuchel 5-pol.	Standard	7S4FK043020026C20
	8 m	DD	BSB 35-50 Tuchel 5-pol.	Standard	7S4FK083020026C20
	4 m	DD	BSB 35-50 Tuchel 5-pol.	High Flex Leder	7S4FH043020026C20
	8 m	DD	BSB 35-50 Tuchel 5-pol.	High Flex Leder	7S4FH083020026C20
ABITIG® 20	4 m	DD	BSB 35-50 Tuchel 5-pol.	Standard	7S5SK043020026C20
	8 m	DD	BSB 35-50 Tuchel 5-pol.	Standard	7S5SK083020026C20
	4 m	DD	BSB 35-50 Tuchel 5-pol.	High Flex Leder	7S5SH043020026C20
	8 m	DD	BSB 35-50 Tuchel 5-pol.	High Flex Leder	7S5SH083020026C20
ABITIG® 20F	4 m	DD	BSB 35-50 Tuchel 5-pol.	Standard	7S5FK043020026C20
	8 m	DD	BSB 35-50 Tuchel 5-pol.	Standard	7S5FK083020026C20
	4 m	DD	BSB 35-50 Tuchel 5-pol.	High Flex Leder	7S5FH043020026C20
	8 m	DD	BSB 35-50 Tuchel 5-pol.	High Flex Leder	7S5FH083020026C20

Technische Änderungen vorbehalten • Verkaufspreise = unverbindliche Preisempfehlung - Angebot freibleibend • © Copyright

ABITIG®-Brennerpreisliste

passend für WIG-Stromquellen des Fabrikates „kjellberg“

Brennertyp	Länge	Schalterfunktion	maschinenseitiger Anschluss	Schlauchpaketausführung	Bestellnummer
ABITIG® 12-1	4 m	DD	BSB 35-50 Tuchel 5-pol.	Standard	7S6SK043020026C20
	8 m	DD	BSB 35-50 Tuchel 5-pol.	Standard	7S6SK083020026C20
	4 m	DD	BSB 35-50 Tuchel 5-pol.	High Flex Leder	7S6SH043020026C20
	8 m	DD	BSB 35-50 Tuchel 5-pol.	High Flex Leder	7S6SH083020026C20
ABITIG® 18SC	4 m	DD	BSB 35-50 Tuchel 5-pol.	Standard	7S7SK043020026C20
	8 m	DD	BSB 35-50 Tuchel 5-pol.	Standard	7S7SK083020026C20
	4 m	DD	BSB 35-50 Tuchel 5-pol.	High Flex Leder	7S7SH043020026C20
	8 m	DD	BSB 35-50 Tuchel 5-pol.	High Flex Leder	7S7SH083020026C20
ABITIG® 24W	4 m	DD	BSB 35-50 Tuchel 5-pol.	Standard	7S9SK043020026C20
	8 m	DD	BSB 35-50 Tuchel 5-pol.	Standard	7S9SK083020026C20
	4 m	DD	BSB 35-50 Tuchel 5-pol.	High Flex Leder	7S9SH043020026C20
	8 m	DD	BSB 35-50 Tuchel 5-pol.	High Flex Leder	7S9SH083020026C20
ABITIG® 450W	4 m	DD	BSB 35-50 Tuchel 5-pol.	Standard	7T5SK043020126C20
	8 m	DD	BSB 35-50 Tuchel 5-pol.	Standard	7T5SK083020126C20
	4 m	DD	BSB 35-50 Tuchel 5-pol.	High Flex Leder	7T5SH043020126C20
	8 m	DD	BSB 35-50 Tuchel 5-pol.	High Flex Leder	7T5SH083020126C20
ABITIG® 260W	4 m	DD	BSB 35-50 Tuchel 5-pol.	Standard	7T7SK043020126C20
	8 m	DD	BSB 35-50 Tuchel 5-pol.	Standard	7T7SK083020126C20
	4 m	DD	BSB 35-50 Tuchel 5-pol.	High Flex Leder	7T7SH043020126C20
	8 m	DD	BSB 35-50 Tuchel 5-pol.	High Flex Leder	7T7SH083020126C20
ABITIG® 450W SC	4 m	DD	BSB 35-50 Tuchel 5-pol.	Standard	
	8 m	DD	BSB 35-50 Tuchel 5-pol.	Standard	
	4 m	DD	BSB 35-50 Tuchel 5-pol.	High Flex Leder	7T8SH043020126C20
	8 m	DD	BSB 35-50 Tuchel 5-pol.	High Flex Leder	7T8SH083020126C20

ABITIG®-Brennerpreisliste

passend für WIG-Stromquellen des Fabrikates „kjellberg“



Brennertyp	Länge	Schalterfunktion	maschinenseitiger Anschluss	Schlauchpaketausführung	Bestellnummer
ABITIG® 18	4 m	EDP	BSB 35-50 Tuchel 7-pol.	Standard	7S4SK046040027A20
	8 m	EDP	BSB 35-50 Tuchel 7-pol.	Standard	7S4SK086040027A20
	4 m	EDP	BSB 35-50 Tuchel 7-pol.	High Flex Leder	7S4SH046040027A20
	8 m	EDP	BSB 35-50 Tuchel 7-pol.	High Flex Leder	7S4SH086040027A20

ABITIG® 18F	4 m	EDP	BSB 35-50 Tuchel 7-pol.	Standard	7S4FK046040027A20
	8 m	EDP	BSB 35-50 Tuchel 7-pol.	Standard	7S4FK086040027A20
	4 m	EDP	BSB 35-50 Tuchel 7-pol.	High Flex Leder	7S4FH046040027A20
	8 m	EDP	BSB 35-50 Tuchel 7-pol.	High Flex Leder	7S4FH086040027A20

ABITIG® 20	4 m	EDP	BSB 35-50 Tuchel 7-pol.	Standard	7S5SK046040027A20
	8 m	EDP	BSB 35-50 Tuchel 7-pol.	Standard	7S5SK086040027A20
	4 m	EDP	BSB 35-50 Tuchel 7-pol.	High Flex Leder	7S5SH046040027A20
	8 m	EDP	BSB 35-50 Tuchel 7-pol.	High Flex Leder	7S5SH086040027A20

ABITIG® 20F	4 m	EDP	BSB 35-50 Tuchel 7-pol.	Standard	7S5FK046040027A20
	8 m	EDP	BSB 35-50 Tuchel 7-pol.	Standard	7S5FK086040027A20
	4 m	EDP	BSB 35-50 Tuchel 7-pol.	High Flex Leder	7S5FH046040027A20
	8 m	EDP	BSB 35-50 Tuchel 7-pol.	High Flex Leder	7S5FH086040027A20

ABITIG®-Brennerpreisliste

passend für WIG-Stromquellen des Fabrikates „kjellberg“

Brennertyp	Länge	Schalterfunktion	maschinenseitiger Anschluss	Schlauchpaketausführung	Bestellnummer
ABITIG® 12-1	4 m	EDP	BSB 35-50 Tuchel 7-pol.	Standard	7S6SK046040027A20
	8 m	EDP	BSB 35-50 Tuchel 7-pol.	Standard	7S6SK086040027A20
	4 m	EDP	BSB 35-50 Tuchel 7-pol.	High Flex Leder	7S6SH046040027A20
	8 m	EDP	BSB 35-50 Tuchel 7-pol.	High Flex Leder	7S6SH086040027A20

ABITIG® 18SC	4 m	EDP	BSB 35-50 Tuchel 7-pol.	Standard	7S7SK046040027A20
	8 m	EDP	BSB 35-50 Tuchel 7-pol.	Standard	7S7SK086040027A20
	4 m	EDP	BSB 35-50 Tuchel 7-pol.	High Flex Leder	7S7SH046040027A20
	8 m	EDP	BSB 35-50 Tuchel 7-pol.	High Flex Leder	7S7SH086040027A20

ABITIG® 24W	4 m	EDP	BSB 35-50 Tuchel 7-pol.	Standard	7S9SK046040027A20
	8 m	EDP	BSB 35-50 Tuchel 7-pol.	Standard	7S9SK086040027A20
	4 m	EDP	BSB 35-50 Tuchel 7-pol.	High Flex Leder	7S9SH046040027A20
	8 m	EDP	BSB 35-50 Tuchel 7-pol.	High Flex Leder	7S9SH086040027A20

ABITIG® 450W	4 m	EDP	BSB 35-50 Tuchel 7-pol.	Standard	7T5SK046040127A20
	8 m	EDP	BSB 35-50 Tuchel 7-pol.	Standard	7T5SK086040127A20
	4 m	EDP	BSB 35-50 Tuchel 7-pol.	High Flex Leder	7T5SH046040127A20
	8 m	EDP	BSB 35-50 Tuchel 7-pol.	High Flex Leder	7T5SH086040127A20

ABITIG® 260W	4 m	EDP	BSB 35-50 Tuchel 7-pol.	Standard	7T7SK046040127A20
	8 m	EDP	BSB 35-50 Tuchel 7-pol.	Standard	7T7SK086040127A20
	4 m	EDP	BSB 35-50 Tuchel 7-pol.	High Flex Leder	7T7SH046040127A20
	8 m	EDP	BSB 35-50 Tuchel 7-pol.	High Flex Leder	7T7SH086040127A20

ABITIG® 450W SC	4 m	EDP	BSB 35-50 Tuchel 7-pol.	Standard	
	8 m	EDP	BSB 35-50 Tuchel 7-pol.	Standard	
	4 m	EDP	BSB 35-50 Tuchel 7-pol.	High Flex Leder	7T8SH046040127A20
	8 m	EDP	BSB 35-50 Tuchel 7-pol.	High Flex Leder	7T8SH086040127A20

ABITIG®-Brennerpreisliste

passend für WIG-Stromquellen des Fabrikates „kjellberg“

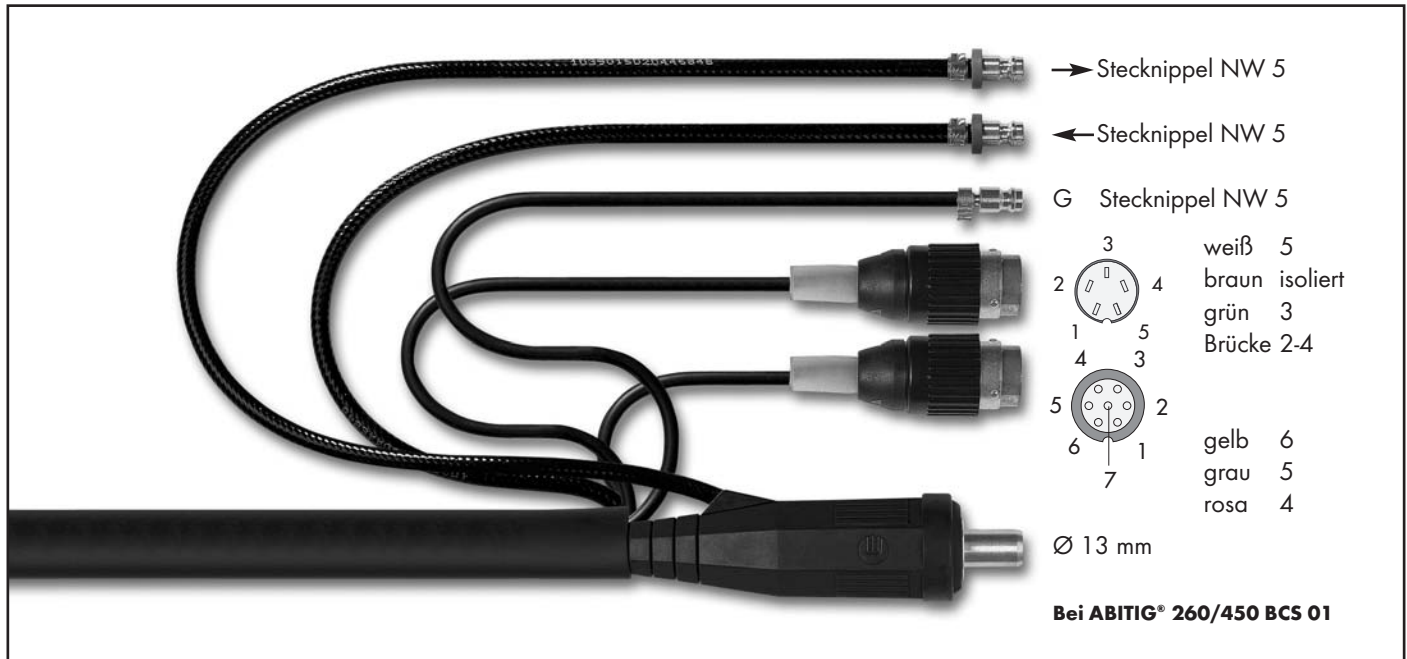

Brennertyp	Länge	Schalterfunktion	maschinenseitiger Anschluss	Schlauchpaketausführung	Bestellnummer
ABITIG® 18	4 m	EDP	BSB 35-50 Tuchel 5-pol./ 7-pol.	Standard	7S4SK046040042B20
	8 m	EDP	BSB 35-50 Tuchel 5-pol./ 7-pol.	Standard	7S4SK086040042B20
	4 m	EDP	BSB 35-50 Tuchel 5-pol./ 7-pol.	High Flex Leder	7S4SH046040042B20
	8 m	EDP	BSB 35-50 Tuchel 5-pol./ 7-pol.	High Flex Leder	7S4SH086040042B20
ABITIG® 18F	4 m	EDP	BSB 35-50 Tuchel 5-pol./ 7-pol.	Standard	7S4FK046040042B20
	8 m	EDP	BSB 35-50 Tuchel 5-pol./ 7-pol.	Standard	7S4FK086040042B20
	4 m	EDP	BSB 35-50 Tuchel 5-pol./ 7-pol.	High Flex Leder	7S4FH046040042B20
	8 m	EDP	BSB 35-50 Tuchel 5-pol./ 7-pol.	High Flex Leder	7S4FH086040042B20
ABITIG® 20	4 m	EDP	BSB 35-50 Tuchel 5-pol./ 7-pol.	Standard	7S5SK046040042B20
	8 m	EDP	BSB 35-50 Tuchel 5-pol./ 7-pol.	Standard	7S5SK086040042B20
	4 m	EDP	BSB 35-50 Tuchel 5-pol./ 7-pol.	High Flex Leder	7S5SH046040042B20
	8 m	EDP	BSB 35-50 Tuchel 5-pol./ 7-pol.	High Flex Leder	7S5SH086040042B20
ABITIG® 20F	4 m	EDP	BSB 35-50 Tuchel 5-pol./ 7-pol.	Standard	7S5FK046040042B20
	8 m	EDP	BSB 35-50 Tuchel 5-pol./ 7-pol.	Standard	7S5FK086040042B20
	4 m	EDP	BSB 35-50 Tuchel 5-pol./ 7-pol.	High Flex Leder	7S5FH046040042B20
	8 m	EDP	BSB 35-50 Tuchel 5-pol./ 7-pol.	High Flex Leder	7S5FH086040042B20

Technische Änderungen vorbehalten • Verkaufspreise = unverbindliche Preisempfehlung - Angebot freibleibend • © Copyright

ABITIG®-Brennerpreisliste

passend für WIG-Stromquellen des Fabrikates „kjellberg“

Brennertyp	Länge	Schalterfunktion	maschinenseitiger Anschluss	Schlauchpaketausführung	Bestellnummer
ABITIG® 12-1	4 m	EDP	BSB 35-50 Tuchel 5-pol./ 7-pol.	Standard	7S6SK046040042B20
	8 m	EDP	BSB 35-50 Tuchel 5-pol./ 7-pol.	Standard	7S6SK086040042B20
	4 m	EDP	BSB 35-50 Tuchel 5-pol./ 7-pol.	High Flex Leder	7S6SH046040042B20
	8 m	EDP	BSB 35-50 Tuchel 5-pol./ 7-pol.	High Flex Leder	7S6SH086040042B20
<hr/>					
ABITIG® 18SC	4 m	EDP	BSB 35-50 Tuchel 5-pol./ 7-pol.	Standard	7S7SK046040042B20
	8 m	EDP	BSB 35-50 Tuchel 5-pol./ 7-pol.	Standard	7S7SK086040042B20
	4 m	EDP	BSB 35-50 Tuchel 5-pol./ 7-pol.	High Flex Leder	7S7SH046040042B20
	8 m	EDP	BSB 35-50 Tuchel 5-pol./ 7-pol.	High Flex Leder	7S7SH086040042B20
<hr/>					
ABITIG® 24W	4 m	EDP	BSB 35-50 Tuchel 5-pol./ 7-pol.	Standard	7S9SK046040042B20
	8 m	EDP	BSB 35-50 Tuchel 5-pol./ 7-pol.	Standard	7S9SK086040042B20
	4 m	EDP	BSB 35-50 Tuchel 5-pol./ 7-pol.	High Flex Leder	7S9SH046040042B20
	8 m	EDP	BSB 35-50 Tuchel 5-pol./ 7-pol.	High Flex Leder	7S9SH086040042B20
<hr/>					
ABITIG® 450W	4 m	EDP	BSB 35-50 Tuchel 5-pol./ 7-pol.	Standard	7T5SK046040142B20
	8 m	EDP	BSB 35-50 Tuchel 5-pol./ 7-pol.	Standard	7T5SK086040142B20
	4 m	EDP	BSB 35-50 Tuchel 5-pol./ 7-pol.	High Flex Leder	7T5SH046040142B20
	8 m	EDP	BSB 35-50 Tuchel 5-pol./ 7-pol.	High Flex Leder	7T5SH086040142B20
<hr/>					
ABITIG® 260W	4 m	EDP	BSB 35-50 Tuchel 5-pol./ 7-pol.	Standard	7T7SK046040142B20
	8 m	EDP	BSB 35-50 Tuchel 5-pol./ 7-pol.	Standard	7T7SK086040142B20
	4 m	EDP	BSB 35-50 Tuchel 5-pol./ 7-pol.	High Flex Leder	7T7SH046040142B20
	8 m	EDP	BSB 35-50 Tuchel 5-pol./ 7-pol.	High Flex Leder	7T7SH086040142B20
<hr/>					
ABITIG® 450W SC	4 m	EDP	BSB 35-50 Tuchel 5-pol./ 7-pol.	Standard	
	8 m	EDP	BSB 35-50 Tuchel 5-pol./ 7-pol.	Standard	
	4 m	EDP	BSB 35-50 Tuchel 5-pol./ 7-pol.	High Flex Leder	7T8SH046040142B20
	8 m	EDP	BSB 35-50 Tuchel 5-pol./ 7-pol.	High Flex Leder	7T8SH086040142B20

ABITIG®-Brennerpreisliste

passend für WIG-Stromquellen des Fabrikates „lincoln“

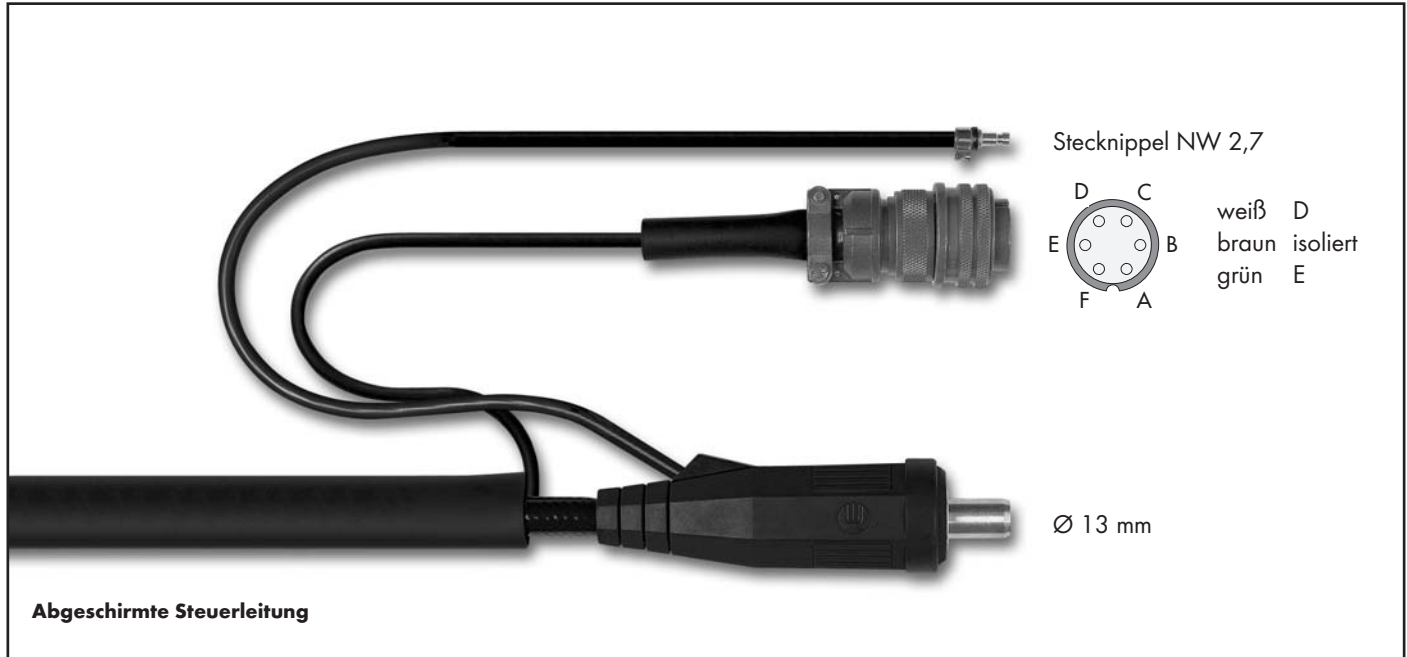

Brennertyp	Länge	Schalterfunktion	maschinenseitiger Anschluss	Schlauchpaketausführung	Bestellnummer
ABITIG® 9	4 m	ED	BSB 35-50 Amphenol 6-pol.	Standard	7S1SK047010038A05
	8 m	ED	BSB 35-50 Amphenol 6-pol.	Standard	7S1SK087010038A05
	4 m	ED	BSB 35-50 Amphenol 6-pol.	High Flex Leder	7S1SH047010038A05
	8 m	ED	BSB 35-50 Amphenol 6-pol.	High Flex Leder	7S1SH087010038A05

ABITIG® 9F	4 m	ED	BSB 35-50 Amphenol 6-pol.	Standard	7S1FK047010038A05
	8 m	ED	BSB 35-50 Amphenol 6-pol.	Standard	7S1FK087010038A05
	4 m	ED	BSB 35-50 Amphenol 6-pol.	High Flex Leder	7S1FH047010038A05
	8 m	ED	BSB 35-50 Amphenol 6-pol.	High Flex Leder	7S1FH087010038A05

ABITIG® 17	4 m	ED	BSB 35-50 Amphenol 6-pol.	Standard	7S2SK047010038A05
	8 m	ED	BSB 35-50 Amphenol 6-pol.	Standard	7S2SK087010038A05
	4 m	ED	BSB 35-50 Amphenol 6-pol.	High Flex Leder	7S2SH047010038A05
	8 m	ED	BSB 35-50 Amphenol 6-pol.	High Flex Leder	7S2SH087010038A05

ABITIG® 17F	4 m	ED	BSB 35-50 Amphenol 6-pol.	Standard	7S2FK047010038A05
	8 m	ED	BSB 35-50 Amphenol 6-pol.	Standard	7S2FK087010038A05
	4 m	ED	BSB 35-50 Amphenol 6-pol.	High Flex Leder	7S2FH047010038A05
	8 m	ED	BSB 35-50 Amphenol 6-pol.	High Flex Leder	7S2FH087010038A05

Technische Änderungen vorbehalten • Verkaufspreise = unverbindliche Preisempfehlung - Angebot freibleibend • © Copyright

ABITIG®-Brennerpreisliste

passend für WIG-Stromquellen des Fabrikates „lincoln“

Brennertyp	Länge	Schalterfunktion	maschinenseitiger Anschluss	Schlauchpaketausführung	Bestellnummer
ABITIG® 26	4 m	ED	BSB 35-50 Amphenol 6-pol.	Standard	7S3SK047010038A05
	8 m	ED	BSB 35-50 Amphenol 6-pol.	Standard	7S3SK087010038A05
	4 m	ED	BSB 35-50 Amphenol 6-pol.	High Flex Leder	7S3SH047010038A05
	8 m	ED	BSB 35-50 Amphenol 6-pol.	High Flex Leder	7S3SH087010038A05
ABITIG® 26F	4 m	ED	BSB 35-50 Amphenol 6-pol.	Standard	7S3FK047010038A05
	8 m	ED	BSB 35-50 Amphenol 6-pol.	Standard	7S3FK087010038A05
	4 m	ED	BSB 35-50 Amphenol 6-pol.	High Flex Leder	7S3FH047010038A05
	8 m	ED	BSB 35-50 Amphenol 6-pol.	High Flex Leder	7S3FH087010038A05
ABITIG® 24G	4 m	ED	BSB 35-50 Amphenol 6-pol.	Standard	7S8SK047010038A05
	8 m	ED	BSB 35-50 Amphenol 6-pol.	Standard	7S8SK087010038A05
	4 m	ED	BSB 35-50 Amphenol 6-pol.	High Flex Leder	7S8SH047010038A05
	8 m	ED	BSB 35-50 Amphenol 6-pol.	High Flex Leder	7S8SH087010038A05
ABITIG® 200	4 m	ED	BSB 35-50 Amphenol 6-pol.	Standard	7T4SK047010038A05
	8 m	ED	BSB 35-50 Amphenol 6-pol.	Standard	7T4SK087010038A05
	4 m	ED	BSB 35-50 Amphenol 6-pol.	High Flex Leder	7T4SH047010038A05
	8 m	ED	BSB 35-50 Amphenol 6-pol.	High Flex Leder	7T4SH087010038A05
ABITIG® 200F	4 m	ED	BSB 35-50 Amphenol 6-pol.	Standard	7T4FK047010038A05
	8 m	ED	BSB 35-50 Amphenol 6-pol.	Standard	7T4FK087010038A05
	4 m	ED	BSB 35-50 Amphenol 6-pol.	High Flex Leder	7T4FH047010038A05
	8 m	ED	BSB 35-50 Amphenol 6-pol.	High Flex Leder	7T4FH087010038A05
ABITIG® 150	4 m	ED	BSB 35-50 Amphenol 6-pol.	Standard	7T6SK047010038A05
	8 m	ED	BSB 35-50 Amphenol 6-pol.	Standard	7T6SK087010038A05
	4 m	ED	BSB 35-50 Amphenol 6-pol.	High Flex Leder	7T6SH047010038A05
	8 m	ED	BSB 35-50 Amphenol 6-pol.	High Flex Leder	7T6SH087010038A05
ABITIG® 150F	4 m	ED	BSB 35-50 Amphenol 6-pol.	Standard	7T6FK047010038A05
	8 m	ED	BSB 35-50 Amphenol 6-pol.	Standard	7T6FK087010038A05
	4 m	ED	BSB 35-50 Amphenol 6-pol.	High Flex Leder	7T6FH047010038A05
	8 m	ED	BSB 35-50 Amphenol 6-pol.	High Flex Leder	7T6FH087010038A05

ABITIG®-Brennerpreisliste

passend für WIG-Stromquellen des Fabrikates „lincoln“



Brennertyp	Länge	Schalterfunktion	maschinenseitiger Anschluss	Schlauchpaketausführung	Bestellnummer
ABITIG® 9	4 m	ED	BSB 35-50 Tuchel 5-pol.	Standard	7S1SK043010001A05
	8 m	ED	BSB 35-50 Tuchel 5-pol.	Standard	7S1SK083010001A05
	4 m	ED	BSB 35-50 Tuchel 5-pol.	High Flex Leder	7S1SH043010001A05
	8 m	ED	BSB 35-50 Tuchel 5-pol.	High Flex Leder	7S1SH083010001A05

ABITIG® 9F	4 m	ED	BSB 35-50 Tuchel 5-pol.	Standard	7S1FK043010001A05
	8 m	ED	BSB 35-50 Tuchel 5-pol.	Standard	7S1FK083010001A05
	4 m	ED	BSB 35-50 Tuchel 5-pol.	High Flex Leder	7S1FH043010001A05
	8 m	ED	BSB 35-50 Tuchel 5-pol.	High Flex Leder	7S1FH083010001A05

ABITIG® 17	4 m	ED	BSB 35-50 Tuchel 5-pol.	Standard	7S2SK043010001A05
	8 m	ED	BSB 35-50 Tuchel 5-pol.	Standard	7S2SK083010001A05
	4 m	ED	BSB 35-50 Tuchel 5-pol.	High Flex Leder	7S2SH043010001A05
	8 m	ED	BSB 35-50 Tuchel 5-pol.	High Flex Leder	7S2SH083010001A05

ABITIG® 17F	4 m	ED	BSB 35-50 Tuchel 5-pol.	Standard	7S2FK043010001A05
	8 m	ED	BSB 35-50 Tuchel 5-pol.	Standard	7S2FK083010001A05
	4 m	ED	BSB 35-50 Tuchel 5-pol.	High Flex Leder	7S2FH043010001A05
	8 m	ED	BSB 35-50 Tuchel 5-pol.	High Flex Leder	7S2FH083010001A05

Technische Änderungen vorbehalten • Verkaufspreise = unverbindliche Preisempfehlung - Angebot freibleibend • © Copyright

ABITIG®-Brennerpreisliste

passend für WIG-Stromquellen des Fabrikates „lincoln“

Brennertyp	Länge	Schalterfunktion	maschinenseitiger Anschluss	Schlauchpaketausführung	Bestellnummer
ABITIG® 26	4 m	ED	BSB 35-50 Tuchel 5-pol.	Standard	7S3SK043010001A05
	8 m	ED	BSB 35-50 Tuchel 5-pol.	Standard	7S3SK083010001A05
	4 m	ED	BSB 35-50 Tuchel 5-pol.	High Flex Leder	7S3SH043010001A05
	8 m	ED	BSB 35-50 Tuchel 5-pol.	High Flex Leder	7S3SH083010001A05
ABITIG® 26F	4 m	ED	BSB 35-50 Tuchel 5-pol.	Standard	7S3FK043010001A05
	8 m	ED	BSB 35-50 Tuchel 5-pol.	Standard	7S3FK083010001A05
	4 m	ED	BSB 35-50 Tuchel 5-pol.	High Flex Leder	7S3FH043010001A05
	8 m	ED	BSB 35-50 Tuchel 5-pol.	High Flex Leder	7S3FH083010001A05
ABITIG® 24G	4 m	ED	BSB 35-50 Tuchel 5-pol.	Standard	7S8SK043010001A05
	8 m	ED	BSB 35-50 Tuchel 5-pol.	Standard	7S8SK083010001A05
	4 m	ED	BSB 35-50 Tuchel 5-pol.	High Flex Leder	7S8SH043010001A05
	8 m	ED	BSB 35-50 Tuchel 5-pol.	High Flex Leder	7S8SH083010001A05
ABITIG® 200	4 m	ED	BSB 35-50 Tuchel 5-pol.	Standard	7T4SK043010001A05
	8 m	ED	BSB 35-50 Tuchel 5-pol.	Standard	7T4SK083010001A05
	4 m	ED	BSB 35-50 Tuchel 5-pol.	High Flex Leder	7T4SH043010001A05
	8 m	ED	BSB 35-50 Tuchel 5-pol.	High Flex Leder	7T4SH083010001A05
ABITIG® 200F	4 m	ED	BSB 35-50 Tuchel 5-pol.	Standard	7T4FK043010001A05
	8 m	ED	BSB 35-50 Tuchel 5-pol.	Standard	7T4FK083010001A05
	4 m	ED	BSB 35-50 Tuchel 5-pol.	High Flex Leder	7T4FH043010001A05
	8 m	ED	BSB 35-50 Tuchel 5-pol.	High Flex Leder	7T4FH083010001A05
ABITIG® 150	4 m	ED	BSB 35-50 Tuchel 5-pol.	Standard	7T6SK043010001A05
	8 m	ED	BSB 35-50 Tuchel 5-pol.	Standard	7T6SK083010001A05
	4 m	ED	BSB 35-50 Tuchel 5-pol.	High Flex Leder	7T6SH043010001A05
	8 m	ED	BSB 35-50 Tuchel 5-pol.	High Flex Leder	7T6SH083010001A05
ABITIG® 150F	4 m	ED	BSB 35-50 Tuchel 5-pol.	Standard	7T6FK043010001A05
	8 m	ED	BSB 35-50 Tuchel 5-pol.	Standard	7T6FK083010001A05
	4 m	ED	BSB 35-50 Tuchel 5-pol.	High Flex Leder	7T6FH043010001A05
	8 m	ED	BSB 35-50 Tuchel 5-pol.	High Flex Leder	7T6FH083010001A05

ABITIG®-Brennerpreisliste

passend für WIG-Stromquellen des Fabrikates „lincoln/norweld“



Brennertyp	Länge	Schalterfunktion	maschinenseitiger Anschluss	Schlauchpaketausführung	Bestellnummer
ABITIG® 9	4 m	DD	BSB 35-50 Tuchel 5-pol.	Standard	7S1SK043020001B01
	8 m	DD	BSB 35-50 Tuchel 5-pol.	Standard	7S1SK083020001B01
	4 m	DD	BSB 35-50 Tuchel 5-pol.	High Flex Leder	7S1SH043020001B01
	8 m	DD	BSB 35-50 Tuchel 5-pol.	High Flex Leder	7S1SH083020001B01

ABITIG® 9F	4 m	DD	BSB 35-50 Tuchel 5-pol.	Standard	7S1FK043020001B01
	8 m	DD	BSB 35-50 Tuchel 5-pol.	Standard	7S1FK083020001B01
	4 m	DD	BSB 35-50 Tuchel 5-pol.	High Flex Leder	7S1FH043020001B01
	8 m	DD	BSB 35-50 Tuchel 5-pol.	High Flex Leder	7S1FH083020001B01

ABITIG® 17	4 m	DD	BSB 35-50 Tuchel 5-pol.	Standard	7S2SK043020001B01
	8 m	DD	BSB 35-50 Tuchel 5-pol.	Standard	7S2SK083020001B01
	4 m	DD	BSB 35-50 Tuchel 5-pol.	High Flex Leder	7S2SH043020001B01
	8 m	DD	BSB 35-50 Tuchel 5-pol.	High Flex Leder	7S2SH083020001B01

ABITIG® 17F	4 m	DD	BSB 35-50 Tuchel 5-pol.	Standard	7S2FK043020001B01
	8 m	DD	BSB 35-50 Tuchel 5-pol.	Standard	7S2FK083020001B01
	4 m	DD	BSB 35-50 Tuchel 5-pol.	High Flex Leder	7S2FH043020001B01
	8 m	DD	BSB 35-50 Tuchel 5-pol.	High Flex Leder	7S2FH083020001B01

Technische Änderungen vorbehalten • Verkaufspreise = unverbindliche Preisempfehlung - Angebot freibleibend • © Copyright

ABITIG®-Brennerpreisliste

passend für WIG-Stromquellen des Fabrikates „lincoln/norweld“

Brennertyp	Länge	Schalterfunktion	maschinenseitiger Anschluss	Schlauchpaketausführung	Bestellnummer
ABITIG® 26	4 m	DD	BSB 35-50 Tuchel 5-pol.	Standard	7S3SK043020001B01
	8 m	DD	BSB 35-50 Tuchel 5-pol.	Standard	7S3SK083020001B01
	4 m	DD	BSB 35-50 Tuchel 5-pol.	High Flex Leder	7S3SH043020001B01
	8 m	DD	BSB 35-50 Tuchel 5-pol.	High Flex Leder	7S3SH083020001B01

ABITIG® 26F	4 m	DD	BSB 35-50 Tuchel 5-pol.	Standard	7S3FK043020001B01
	8 m	DD	BSB 35-50 Tuchel 5-pol.	Standard	7S3FK083020001B01
	4 m	DD	BSB 35-50 Tuchel 5-pol.	High Flex Leder	7S3FH043020001B01
	8 m	DD	BSB 35-50 Tuchel 5-pol.	High Flex Leder	7S3FH083020001B01

ABITIG® 24G	4 m	DD	BSB 35-50 Tuchel 5-pol.	Standard	7S8SK043020001B01
	8 m	DD	BSB 35-50 Tuchel 5-pol.	Standard	7S8SK083020001B01
	4 m	DD	BSB 35-50 Tuchel 5-pol.	High Flex Leder	7S8SH043020001B01
	8 m	DD	BSB 35-50 Tuchel 5-pol.	High Flex Leder	7S8SH083020001B01

ABITIG® 200	4 m	DD	BSB 35-50 Tuchel 5-pol.	Standard	7T4SK043020001B01
	8 m	DD	BSB 35-50 Tuchel 5-pol.	Standard	7T4SK083020001B01
	4 m	DD	BSB 35-50 Tuchel 5-pol.	High Flex Leder	7T4SH043020001B01
	8 m	DD	BSB 35-50 Tuchel 5-pol.	High Flex Leder	7T4SH083020001B01

ABITIG® 200F	4 m	DD	BSB 35-50 Tuchel 5-pol.	Standard	7T4FK043020001B01
	8 m	DD	BSB 35-50 Tuchel 5-pol.	Standard	7T4FK083020001B01
	4 m	DD	BSB 35-50 Tuchel 5-pol.	High Flex Leder	7T4FH043020001B01
	8 m	DD	BSB 35-50 Tuchel 5-pol.	High Flex Leder	7T4FH083020001B01

ABITIG® 150	4 m	DD	BSB 35-50 Tuchel 5-pol.	Standard	7T6SK043020001B01
	8 m	DD	BSB 35-50 Tuchel 5-pol.	Standard	7T6SK083020001B01
	4 m	DD	BSB 35-50 Tuchel 5-pol.	High Flex Leder	7T6SH043020001B01
	8 m	DD	BSB 35-50 Tuchel 5-pol.	High Flex Leder	7T6SH083020001B01

ABITIG® 150F	4 m	DD	BSB 35-50 Tuchel 5-pol.	Standard	7T6FK043020001B01
	8 m	DD	BSB 35-50 Tuchel 5-pol.	Standard	7T6FK083020001B01
	4 m	DD	BSB 35-50 Tuchel 5-pol.	High Flex Leder	7T6FH043020001B01
	8 m	DD	BSB 35-50 Tuchel 5-pol.	High Flex Leder	7T6FH083020001B01

ABITIG®-Brennerpreisliste

passend für WIG-Stromquellen des Fabrikates „lincoln“

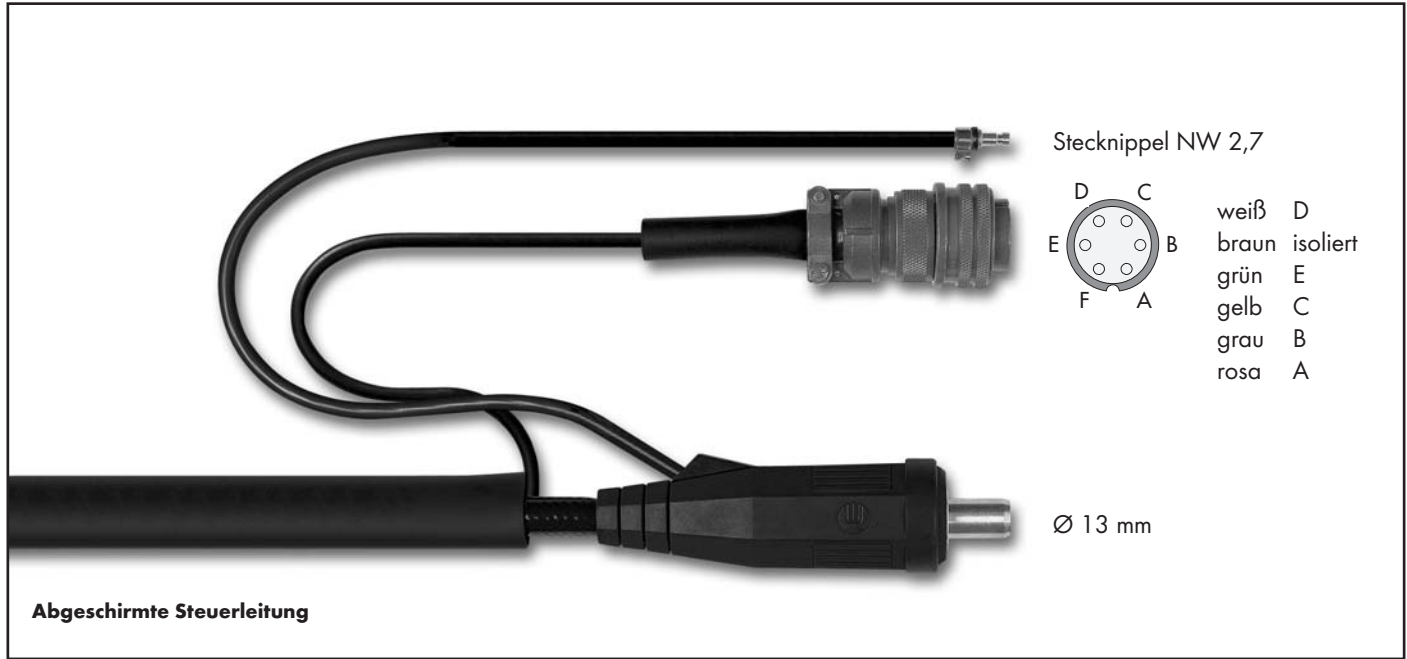

Brennertyp	Länge	Schalterfunktion	maschinenseitiger Anschluss	Schlauchpaketausführung	Bestellnummer
ABITIG® 9	4 m	EDP	BSB 35-50 Amphenol 6-pol.	Standard	7S1SK047040047A05
	8 m	EDP	BSB 35-50 Amphenol 6-pol.	Standard	7S1SK087040047A05
	4 m	EDP	BSB 35-50 Amphenol 6-pol.	High Flex Leder	7S1SH047040047A05
	8 m	EDP	BSB 35-50 Amphenol 6-pol.	High Flex Leder	7S1SH087040047A05
ABITIG® 9F	4 m	EDP	BSB 35-50 Amphenol 6-pol.	Standard	7S1FK047040047A05
	8 m	EDP	BSB 35-50 Amphenol 6-pol.	Standard	7S1FK087040047A05
	4 m	EDP	BSB 35-50 Amphenol 6-pol.	High Flex Leder	7S1FH047040047A05
	8 m	EDP	BSB 35-50 Amphenol 6-pol.	High Flex Leder	7S1FH087040047A05
ABITIG® 17	4 m	EDP	BSB 35-50 Amphenol 6-pol.	Standard	7S2SK047040047A05
	8 m	EDP	BSB 35-50 Amphenol 6-pol.	Standard	7S2SK087040047A05
	4 m	EDP	BSB 35-50 Amphenol 6-pol.	High Flex Leder	7S2SH047040047A05
	8 m	EDP	BSB 35-50 Amphenol 6-pol.	High Flex Leder	7S2SH087040047A05
ABITIG® 17F	4 m	EDP	BSB 35-50 Amphenol 6-pol.	Standard	7S2FK047040047A05
	8 m	EDP	BSB 35-50 Amphenol 6-pol.	Standard	7S2FK087040047A05
	4 m	EDP	BSB 35-50 Amphenol 6-pol.	High Flex Leder	7S2FH047040047A05
	8 m	EDP	BSB 35-50 Amphenol 6-pol.	High Flex Leder	7S2FH087040047A05

Technische Änderungen vorbehalten • Verkaufspreise = unverbindliche Preisempfehlung - Angebot freibleibend • © Copyright

ABITIG®-Brennerpreisliste

passend für WIG-Stromquellen des Fabrikates „lincoln“

Brennertyp	Länge	Schalterfunktion	maschinenseitiger Anschluss	Schlauchpaketausführung	Bestellnummer
ABITIG® 26	4 m	EDP	BSB 35-50 Amphenol 6-pol.	Standard	7S3SK047040047A05
	8 m	EDP	BSB 35-50 Amphenol 6-pol.	Standard	7S3SK087040047A05
	4 m	EDP	BSB 35-50 Amphenol 6-pol.	High Flex Leder	7S3SH047040047A05
	8 m	EDP	BSB 35-50 Amphenol 6-pol.	High Flex Leder	7S3SH087040047A05
ABITIG® 26F	4 m	EDP	BSB 35-50 Amphenol 6-pol.	Standard	7S3FK047040047A05
	8 m	EDP	BSB 35-50 Amphenol 6-pol.	Standard	7S3FK087040047A05
	4 m	EDP	BSB 35-50 Amphenol 6-pol.	High Flex Leder	7S3FH047040047A05
	8 m	EDP	BSB 35-50 Amphenol 6-pol.	High Flex Leder	7S3FH087040047A05
ABITIG® 24G	4 m	EDP	BSB 35-50 Amphenol 6-pol.	Standard	7S8SK047040047A05
	8 m	EDP	BSB 35-50 Amphenol 6-pol.	Standard	7S8SK087040047A05
	4 m	EDP	BSB 35-50 Amphenol 6-pol.	High Flex Leder	7S8SH047040047A05
	8 m	EDP	BSB 35-50 Amphenol 6-pol.	High Flex Leder	7S8SH087040047A05
ABITIG® 200	4 m	EDP	BSB 35-50 Amphenol 6-pol.	Standard	7T4SK047040047A05
	8 m	EDP	BSB 35-50 Amphenol 6-pol.	Standard	7T4SK087040047A05
	4 m	EDP	BSB 35-50 Amphenol 6-pol.	High Flex Leder	7T4SH047040047A05
	8 m	EDP	BSB 35-50 Amphenol 6-pol.	High Flex Leder	7T4SH087040047A05
ABITIG® 200F	4 m	EDP	BSB 35-50 Amphenol 6-pol.	Standard	7T4FK047040047A05
	8 m	EDP	BSB 35-50 Amphenol 6-pol.	Standard	7T4FK087040047A05
	4 m	EDP	BSB 35-50 Amphenol 6-pol.	High Flex Leder	7T4FH047040047A05
	8 m	EDP	BSB 35-50 Amphenol 6-pol.	High Flex Leder	7T4FH087040047A05
ABITIG® 150	4 m	EDP	BSB 35-50 Amphenol 6-pol.	Standard	7T6SK047040047A05
	8 m	EDP	BSB 35-50 Amphenol 6-pol.	Standard	7T6SK087040047A05
	4 m	EDP	BSB 35-50 Amphenol 6-pol.	High Flex Leder	7T6SH047040047A05
	8 m	EDP	BSB 35-50 Amphenol 6-pol.	High Flex Leder	7T6SH087040047A05
ABITIG® 150F	4 m	EDP	BSB 35-50 Amphenol 6-pol.	Standard	7T6FK047040047A05
	8 m	EDP	BSB 35-50 Amphenol 6-pol.	Standard	7T6FK087040047A05
	4 m	EDP	BSB 35-50 Amphenol 6-pol.	High Flex Leder	7T6FH047040047A05
	8 m	EDP	BSB 35-50 Amphenol 6-pol.	High Flex Leder	7T6FH087040047A05

ABITIG®-Brennerpreisliste

passend für WIG-Stromquellen des Fabrikates „lincoln“

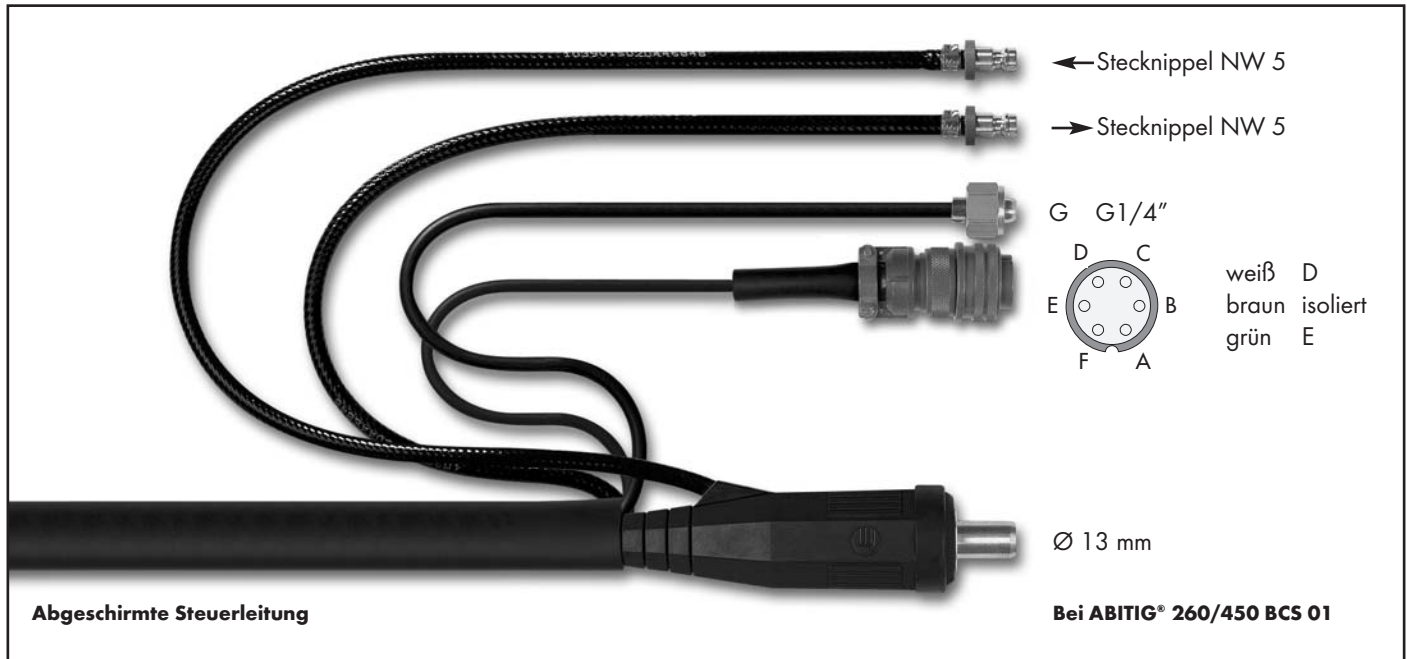

Brennertyp	Länge	Schalterfunktion	maschinenseitiger Anschluss	Schlauchpaketausführung	Bestellnummer
ABITIG® 18	4 m	ED	BSB 35-50 Amphenol 6-pol.	Standard	7S4SK047010038A11
	8 m	ED	BSB 35-50 Amphenol 6-pol.	Standard	7S4SK087010038A11
	4 m	ED	BSB 35-50 Amphenol 6-pol.	High Flex Leder	7S4SH047010038A11
	8 m	ED	BSB 35-50 Amphenol 6-pol.	High Flex Leder	7S4SH087010038A11
ABITIG® 18F	4 m	ED	BSB 35-50 Amphenol 6-pol.	Standard	7S4FK047010038A11
	8 m	ED	BSB 35-50 Amphenol 6-pol.	Standard	7S4FK087010038A11
	4 m	ED	BSB 35-50 Amphenol 6-pol.	High Flex Leder	7S4FH047010038A11
	8 m	ED	BSB 35-50 Amphenol 6-pol.	High Flex Leder	7S4FH087010038A11
ABITIG® 20	4 m	ED	BSB 35-50 Amphenol 6-pol.	Standard	7S5SK047010038A11
	8 m	ED	BSB 35-50 Amphenol 6-pol.	Standard	7S5SK087010038A11
	4 m	ED	BSB 35-50 Amphenol 6-pol.	High Flex Leder	7S5SH047010038A11
	8 m	ED	BSB 35-50 Amphenol 6-pol.	High Flex Leder	7S5SH087010038A11
ABITIG® 20F	4 m	ED	BSB 35-50 Amphenol 6-pol.	Standard	7S5FK047010038A11
	8 m	ED	BSB 35-50 Amphenol 6-pol.	Standard	7S5FK087010038A11
	4 m	ED	BSB 35-50 Amphenol 6-pol.	High Flex Leder	7S5FH047010038A11
	8 m	ED	BSB 35-50 Amphenol 6-pol.	High Flex Leder	7S5FH087010038A11

Technische Änderungen vorbehalten • Verkaufspreise = unverbindliche Preisempfehlung - Angebot freibleibend • © Copyright

ABITIG®-Brennerpreisliste

passend für WIG-Stromquellen des Fabrikates „lincoln“

Brennertyp	Länge	Schalterfunktion	maschinenseitiger Anschluss	Schlauchpaketausführung	Bestellnummer
ABITIG® 12-1	4 m	ED	BSB 35-50 Amphenol 6-pol.	Standard	7S6SK047010038A11
	8 m	ED	BSB 35-50 Amphenol 6-pol.	Standard	7S6SK087010038A11
	4 m	ED	BSB 35-50 Amphenol 6-pol.	High Flex Leder	7S6SH047010038A11
	8 m	ED	BSB 35-50 Amphenol 6-pol.	High Flex Leder	7S6SH087010038A11
ABITIG® 18SC	4 m	ED	BSB 35-50 Amphenol 6-pol.	Standard	7S7SK047010038A11
	8 m	ED	BSB 35-50 Amphenol 6-pol.	Standard	7S7SK087010038A11
	4 m	ED	BSB 35-50 Amphenol 6-pol.	High Flex Leder	7S7SH047010038A11
	8 m	ED	BSB 35-50 Amphenol 6-pol.	High Flex Leder	7S7SH087010038A11
ABITIG® 24W	4 m	ED	BSB 35-50 Amphenol 6-pol.	Standard	7S9SK047010038A11
	8 m	ED	BSB 35-50 Amphenol 6-pol.	Standard	7S9SK087010038A11
	4 m	ED	BSB 35-50 Amphenol 6-pol.	High Flex Leder	7S9SH047010038A11
	8 m	ED	BSB 35-50 Amphenol 6-pol.	High Flex Leder	7S9SH087010038A11
ABITIG® 450W	4 m	ED	BSB 35-50 Amphenol 6-pol.	Standard	7T5SK047010138A11
	8 m	ED	BSB 35-50 Amphenol 6-pol.	Standard	7T5SK087010138A11
	4 m	ED	BSB 35-50 Amphenol 6-pol.	High Flex Leder	7T5SH047010138A11
	8 m	ED	BSB 35-50 Amphenol 6-pol.	High Flex Leder	7T5SH087010138A11
ABITIG® 260W	4 m	ED	BSB 35-50 Amphenol 6-pol.	Standard	7T7SK047010138A11
	8 m	ED	BSB 35-50 Amphenol 6-pol.	Standard	7T7SK087010138A11
	4 m	ED	BSB 35-50 Amphenol 6-pol.	High Flex Leder	7T7SH047010138A11
	8 m	ED	BSB 35-50 Amphenol 6-pol.	High Flex Leder	7T7SH087010138A11
ABITIG® 450W SC	4 m	ED	BSB 35-50 Amphenol 6-pol.	Standard	
	8 m	ED	BSB 35-50 Amphenol 6-pol.	Standard	
	4 m	ED	BSB 35-50 Amphenol 6-pol.	High Flex Leder	7T8SH047010138A11
	8 m	ED	BSB 35-50 Amphenol 6-pol.	High Flex Leder	7T8SH087010138A11

ABITIG®-Brennerpreisliste

passend für WIG-Stromquellen des Fabrikates „lincoln“

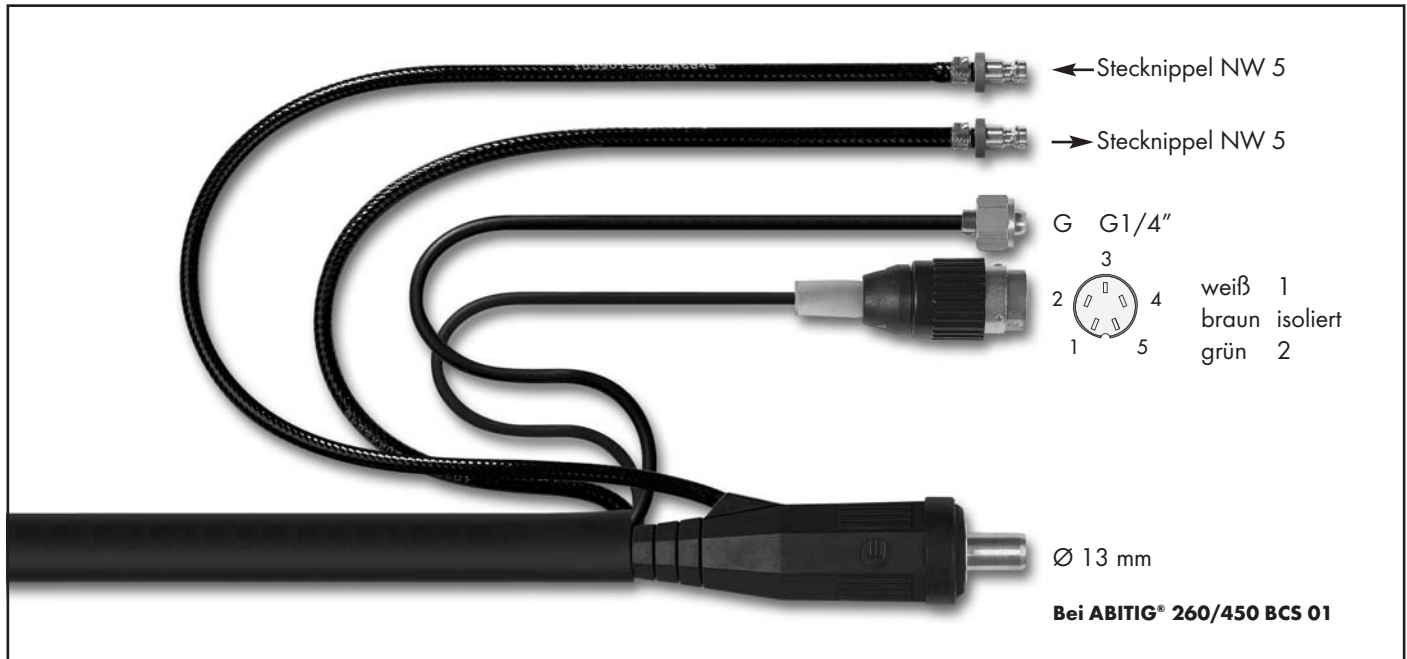

Brennertyp	Länge	Schalterfunktion	maschinenseitiger Anschluss	Schlauchpaketausführung	Bestellnummer
ABITIG® 18	4 m	ED	BSB 35-50 Tuchel 5-pol.	Standard	7S4SK043010001A11
	8 m	ED	BSB 35-50 Tuchel 5-pol.	Standard	7S4SK083010001A11
	4 m	ED	BSB 35-50 Tuchel 5-pol.	High Flex Leder	7S4SH043010001A11
	8 m	ED	BSB 35-50 Tuchel 5-pol.	High Flex Leder	7S4SH083010001A11
ABITIG® 18F	4 m	ED	BSB 35-50 Tuchel 5-pol.	Standard	7S4FK043010001A11
	8 m	ED	BSB 35-50 Tuchel 5-pol.	Standard	7S4FK083010001A11
	4 m	ED	BSB 35-50 Tuchel 5-pol.	High Flex Leder	7S4FH043010001A11
	8 m	ED	BSB 35-50 Tuchel 5-pol.	High Flex Leder	7S4FH083010001A11
ABITIG® 20	4 m	ED	BSB 35-50 Tuchel 5-pol.	Standard	7S5SK043010001A11
	8 m	ED	BSB 35-50 Tuchel 5-pol.	Standard	7S5SK083010001A11
	4 m	ED	BSB 35-50 Tuchel 5-pol.	High Flex Leder	7S5SH043010001A11
	8 m	ED	BSB 35-50 Tuchel 5-pol.	High Flex Leder	7S5SH083010001A11
ABITIG® 20F	4 m	ED	BSB 35-50 Tuchel 5-pol.	Standard	7S5FK043010001A11
	8 m	ED	BSB 35-50 Tuchel 5-pol.	Standard	7S5FK083010001A11
	4 m	ED	BSB 35-50 Tuchel 5-pol.	High Flex Leder	7S5FH043010001A11
	8 m	ED	BSB 35-50 Tuchel 5-pol.	High Flex Leder	7S5FH083010001A11

Technische Änderungen vorbehalten • Verkaufspreise = unverbindliche Preisempfehlung - Angebot freibleibend • © Copyright

ABITIG®-Brennerpreisliste

passend für WIG-Stromquellen des Fabrikates „lincoln“

Brennertyp	Länge	Schalterfunktion	maschinenseitiger Anschluss	Schlauchpaketausführung	Bestellnummer
ABITIG® 12-1	4 m	ED	BSB 35-50 Tuchel 5-pol.	Standard	7S6SK043010001A11
	8 m	ED	BSB 35-50 Tuchel 5-pol.	Standard	7S6SK083010001A11
	4 m	ED	BSB 35-50 Tuchel 5-pol.	High Flex Leder	7S6SH043010001A11
	8 m	ED	BSB 35-50 Tuchel 5-pol.	High Flex Leder	7S6SH083010001A11
ABITIG® 18SC	4 m	ED	BSB 35-50 Tuchel 5-pol.	Standard	7S7SK043010001A11
	8 m	ED	BSB 35-50 Tuchel 5-pol.	Standard	7S7SK083010001A11
	4 m	ED	BSB 35-50 Tuchel 5-pol.	High Flex Leder	7S7SH043010001A11
	8 m	ED	BSB 35-50 Tuchel 5-pol.	High Flex Leder	7S7SH083010001A11
ABITIG® 24W	4 m	ED	BSB 35-50 Tuchel 5-pol.	Standard	7S9SK043010001A11
	8 m	ED	BSB 35-50 Tuchel 5-pol.	Standard	7S9SK083010001A11
	4 m	ED	BSB 35-50 Tuchel 5-pol.	High Flex Leder	7S9SH043010001A11
	8 m	ED	BSB 35-50 Tuchel 5-pol.	High Flex Leder	7S9SH083010001A11
ABITIG® 450W	4 m	ED	BSB 35-50 Tuchel 5-pol.	Standard	7T5SK043010101A11
	8 m	ED	BSB 35-50 Tuchel 5-pol.	Standard	7T5SK083010101A11
	4 m	ED	BSB 35-50 Tuchel 5-pol.	High Flex Leder	7T5SH043010101A11
	8 m	ED	BSB 35-50 Tuchel 5-pol.	High Flex Leder	7T5SH083010101A11
ABITIG® 260W	4 m	ED	BSB 35-50 Tuchel 5-pol.	Standard	7T7SK043010101A11
	8 m	ED	BSB 35-50 Tuchel 5-pol.	Standard	7T7SK083010101A11
	4 m	ED	BSB 35-50 Tuchel 5-pol.	High Flex Leder	7T7SH043010101A11
	8 m	ED	BSB 35-50 Tuchel 5-pol.	High Flex Leder	7T7SH083010101A11
ABITIG® 450W SC	4 m	ED	BSB 35-50 Tuchel 5-pol.	Standard	
	8 m	ED	BSB 35-50 Tuchel 5-pol.	Standard	
	4 m	ED	BSB 35-50 Tuchel 5-pol.	High Flex Leder	7T8SH043010101A11
	8 m	ED	BSB 35-50 Tuchel 5-pol.	High Flex Leder	7T8SH083010101A11

ABITIG®-Brennerpreisliste

passend für WIG-Stromquellen des Fabrikates „lincoln“

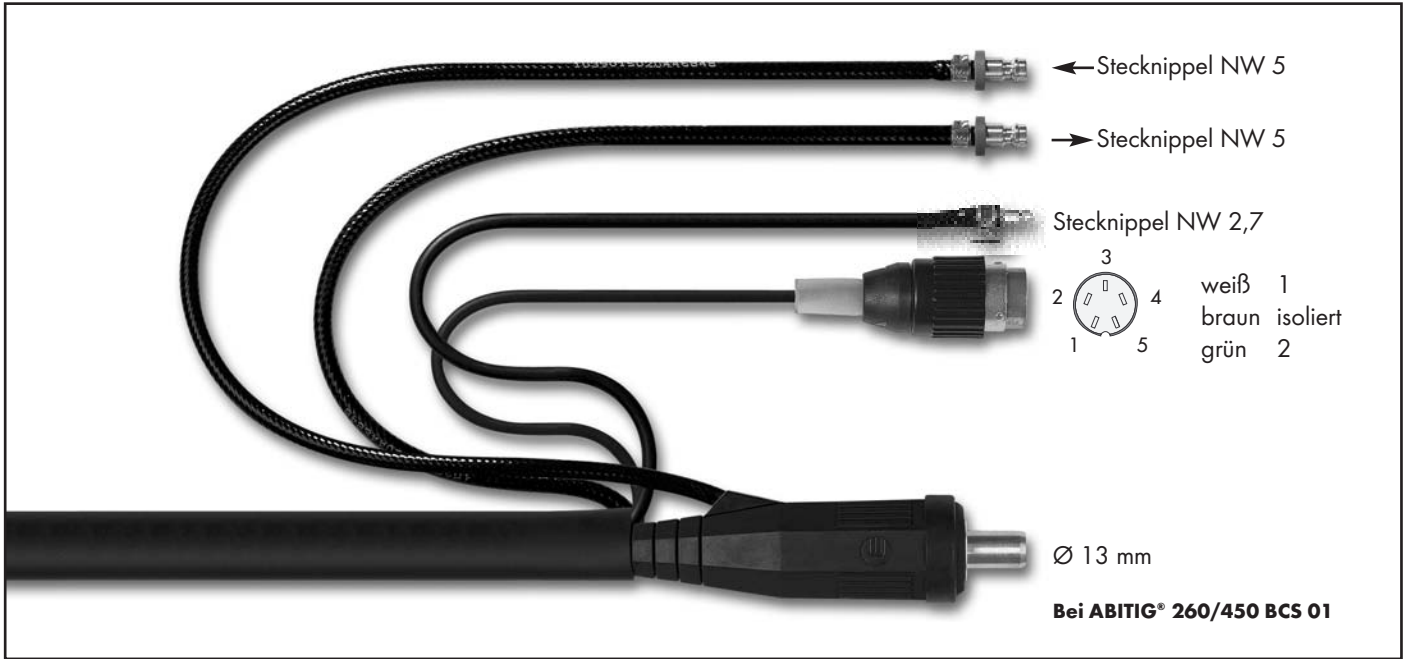

Brennertyp	Länge	Schalterfunktion	maschinenseitiger Anschluss	Schlauchpaketausführung	Bestellnummer
ABITIG® 18	4 m	ED	BSB 35-50 Tuchel 5-pol.	Standard	7S4SK043010001A16
	8 m	ED	BSB 35-50 Tuchel 5-pol.	Standard	7S4SK083010001A16
	4 m	ED	BSB 35-50 Tuchel 5-pol.	High Flex Leder	7S4SH043010001A16
	8 m	ED	BSB 35-50 Tuchel 5-pol.	High Flex Leder	7S4SH083010001A16
ABITIG® 18F	4 m	ED	BSB 35-50 Tuchel 5-pol.	Standard	7S4FK043010001A16
	8 m	ED	BSB 35-50 Tuchel 5-pol.	Standard	7S4FK083010001A16
	4 m	ED	BSB 35-50 Tuchel 5-pol.	High Flex Leder	7S4FH043010001A16
	8 m	ED	BSB 35-50 Tuchel 5-pol.	High Flex Leder	7S4FH083010001A16
ABITIG® 20	4 m	ED	BSB 35-50 Tuchel 5-pol.	Standard	7S5SK043010001A16
	8 m	ED	BSB 35-50 Tuchel 5-pol.	Standard	7S5SK083010001A16
	4 m	ED	BSB 35-50 Tuchel 5-pol.	High Flex Leder	7S5SH043010001A16
	8 m	ED	BSB 35-50 Tuchel 5-pol.	High Flex Leder	7S5SH083010001A16
ABITIG® 20F	4 m	ED	BSB 35-50 Tuchel 5-pol.	Standard	7S5FK043010001A16
	8 m	ED	BSB 35-50 Tuchel 5-pol.	Standard	7S5FK083010001A16
	4 m	ED	BSB 35-50 Tuchel 5-pol.	High Flex Leder	7S5FH043010001A16
	8 m	ED	BSB 35-50 Tuchel 5-pol.	High Flex Leder	7S5FH083010001A16

Technische Änderungen vorbehalten • Verkaufspreise = unverbindliche Preisempfehlung - Angebot freibleibend • © Copyright

ABITIG®-Brennerpreisliste

passend für WIG-Stromquellen des Fabrikates „lincoln“

Brennertyp	Länge	Schalterfunktion	maschinenseitiger Anschluss	Schlauchpaketausführung	Bestellnummer
ABITIG® 12-1	4 m	ED	BSB 35-50 Tuchel 5-pol.	Standard	7S6SK043010001A16
	8 m	ED	BSB 35-50 Tuchel 5-pol.	Standard	7S6SK083010001A16
	4 m	ED	BSB 35-50 Tuchel 5-pol.	High Flex Leder	7S6SH043010001A16
	8 m	ED	BSB 35-50 Tuchel 5-pol.	High Flex Leder	7S6SH083010001A16
ABITIG® 18SC	4 m	ED	BSB 35-50 Tuchel 5-pol.	Standard	7S7SK043010001A16
	8 m	ED	BSB 35-50 Tuchel 5-pol.	Standard	7S7SK083010001A16
	4 m	ED	BSB 35-50 Tuchel 5-pol.	High Flex Leder	7S7SH043010001A16
	8 m	ED	BSB 35-50 Tuchel 5-pol.	High Flex Leder	7S7SH083010001A16
ABITIG® 24W	4 m	ED	BSB 35-50 Tuchel 5-pol.	Standard	7S9SK043010001A16
	8 m	ED	BSB 35-50 Tuchel 5-pol.	Standard	7S9SK083010001A16
	4 m	ED	BSB 35-50 Tuchel 5-pol.	High Flex Leder	7S9SH043010001A16
	8 m	ED	BSB 35-50 Tuchel 5-pol.	High Flex Leder	7S9SH083010001A16
ABITIG® 450W	4 m	ED	BSB 35-50 Tuchel 5-pol.	Standard	7T5SK043010101A16
	8 m	ED	BSB 35-50 Tuchel 5-pol.	Standard	7T5SK083010101A16
	4 m	ED	BSB 35-50 Tuchel 5-pol.	High Flex Leder	7T5SH043010101A16
	8 m	ED	BSB 35-50 Tuchel 5-pol.	High Flex Leder	7T5SH083010101A16
ABITIG® 260W	4 m	ED	BSB 35-50 Tuchel 5-pol.	Standard	7T7SK043010101A16
	8 m	ED	BSB 35-50 Tuchel 5-pol.	Standard	7T7SK083010101A16
	4 m	ED	BSB 35-50 Tuchel 5-pol.	High Flex Leder	7T7SH043010101A16
	8 m	ED	BSB 35-50 Tuchel 5-pol.	High Flex Leder	7T7SH083010101A16
ABITIG® 450W SC	4 m	ED	BSB 35-50 Tuchel 5-pol.	Standard	
	8 m	ED	BSB 35-50 Tuchel 5-pol.	Standard	
	4 m	ED	BSB 35-50 Tuchel 5-pol.	High Flex Leder	7T8SH043010101A16
	8 m	ED	BSB 35-50 Tuchel 5-pol.	High Flex Leder	7T8SH083010101A16

ABITIG®-Brennerpreisliste

passend für WIG-Stromquellen des Fabrikates „lincoln“

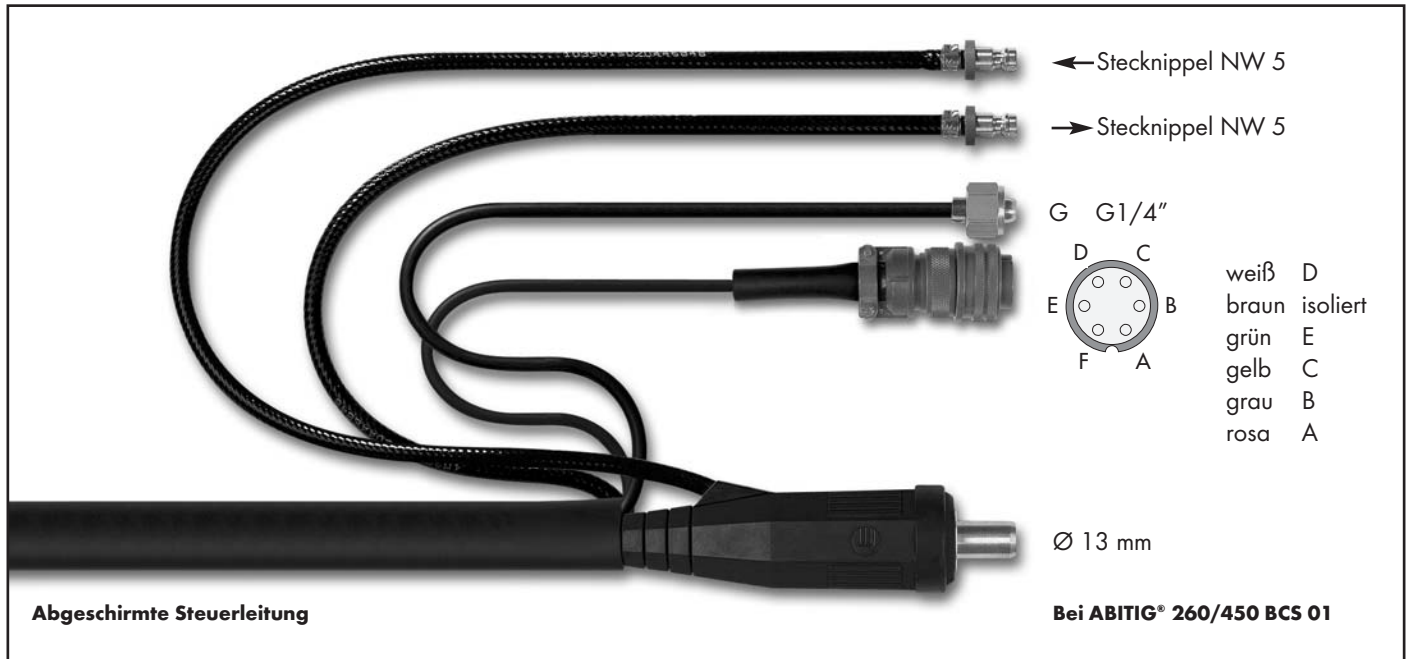

Brennertyp	Länge	Schalterfunktion	maschinenseitiger Anschluss	Schlauchpaketausführung	Bestellnummer
ABITIG® 18	4 m	EDP	BSB 35-50 Amphenol 6-pol.	Standard	7S4SK047010047A11
	8 m	EDP	BSB 35-50 Amphenol 6-pol.	Standard	7S4SK087010047A11
	4 m	EDP	BSB 35-50 Amphenol 6-pol.	High Flex Leder	7S4SH047010047A11
	8 m	EDP	BSB 35-50 Amphenol 6-pol.	High Flex Leder	7S4SH087010047A11
ABITIG® 18F	4 m	EDP	BSB 35-50 Amphenol 6-pol.	Standard	7S4FK047010047A11
	8 m	EDP	BSB 35-50 Amphenol 6-pol.	Standard	7S4FK087010047A11
	4 m	EDP	BSB 35-50 Amphenol 6-pol.	High Flex Leder	7S4FH047010047A11
	8 m	EDP	BSB 35-50 Amphenol 6-pol.	High Flex Leder	7S4FH087010047A11
ABITIG® 20	4 m	EDP	BSB 35-50 Amphenol 6-pol.	Standard	7S5SK047010047A11
	8 m	EDP	BSB 35-50 Amphenol 6-pol.	Standard	7S5SK087010047A11
	4 m	EDP	BSB 35-50 Amphenol 6-pol.	High Flex Leder	7S5SH047010047A11
	8 m	EDP	BSB 35-50 Amphenol 6-pol.	High Flex Leder	7S5SH087010047A11
ABITIG® 20F	4 m	EDP	BSB 35-50 Amphenol 6-pol.	Standard	7S5FK047010047A11
	8 m	EDP	BSB 35-50 Amphenol 6-pol.	Standard	7S5FK087010047A11
	4 m	EDP	BSB 35-50 Amphenol 6-pol.	High Flex Leder	7S5FH047010047A11
	8 m	EDP	BSB 35-50 Amphenol 6-pol.	High Flex Leder	7S5FH087010047A11

Technische Änderungen vorbehalten • Verkaufspreise = unverbindliche Preisempfehlung - Angebot freibleibend • © Copyright

ABITIG®-Brennerpreisliste

passend für WIG-Stromquellen des Fabrikates „lincoln“

Brennertyp	Länge	Schalterfunktion	maschinenseitiger Anschluss	Schlauchpaketausführung	Bestellnummer
ABITIG® 12-1	4 m	EDP	BSB 35-50 Amphenol 6-pol.	Standard	7S6SK047010047A11
	8 m	EDP	BSB 35-50 Amphenol 6-pol.	Standard	7S6SK087010047A11
	4 m	EDP	BSB 35-50 Amphenol 6-pol.	High Flex Leder	7S6SH047010047A11
	8 m	EDP	BSB 35-50 Amphenol 6-pol.	High Flex Leder	7S6SH087010047A11
ABITIG® 18SC	4 m	EDP	BSB 35-50 Amphenol 6-pol.	Standard	7S7SK047010047A11
	8 m	EDP	BSB 35-50 Amphenol 6-pol.	Standard	7S7SK087010047A11
	4 m	EDP	BSB 35-50 Amphenol 6-pol.	High Flex Leder	7S7SH047010047A11
	8 m	EDP	BSB 35-50 Amphenol 6-pol.	High Flex Leder	7S7SH087010047A11
ABITIG® 24W	4 m	EDP	BSB 35-50 Amphenol 6-pol.	Standard	7S9SK047010047A11
	8 m	EDP	BSB 35-50 Amphenol 6-pol.	Standard	7S9SK087010047A11
	4 m	EDP	BSB 35-50 Amphenol 6-pol.	High Flex Leder	7S9SH047010047A11
	8 m	EDP	BSB 35-50 Amphenol 6-pol.	High Flex Leder	7S9SH087010047A11
ABITIG® 450W	4 m	EDP	BSB 35-50 Amphenol 6-pol.	Standard	7T5SK047010147A11
	8 m	EDP	BSB 35-50 Amphenol 6-pol.	Standard	7T5SK087010147A11
	4 m	EDP	BSB 35-50 Amphenol 6-pol.	High Flex Leder	7T5SH047010147A11
	8 m	EDP	BSB 35-50 Amphenol 6-pol.	High Flex Leder	7T5SH087010147A11
ABITIG® 260W	4 m	EDP	BSB 35-50 Amphenol 6-pol.	Standard	7T7SK047010147A11
	8 m	EDP	BSB 35-50 Amphenol 6-pol.	Standard	7T7SK087010147A11
	4 m	EDP	BSB 35-50 Amphenol 6-pol.	High Flex Leder	7T7SH047010147A11
	8 m	EDP	BSB 35-50 Amphenol 6-pol.	High Flex Leder	7T7SH087010147A11
ABITIG® 450W SC	4 m	EDP	BSB 35-50 Amphenol 6-pol.	Standard	
	8 m	EDP	BSB 35-50 Amphenol 6-pol.	Standard	
	4 m	EDP	BSB 35-50 Amphenol 6-pol.	High Flex Leder	7T8SH047010147A11
	8 m	EDP	BSB 35-50 Amphenol 6-pol.	High Flex Leder	7T8SH087010147A11

ABITIG®-Brennerpreisliste

passend für WIG-Stromquellen des Fabrikates „lincoln/norweld“

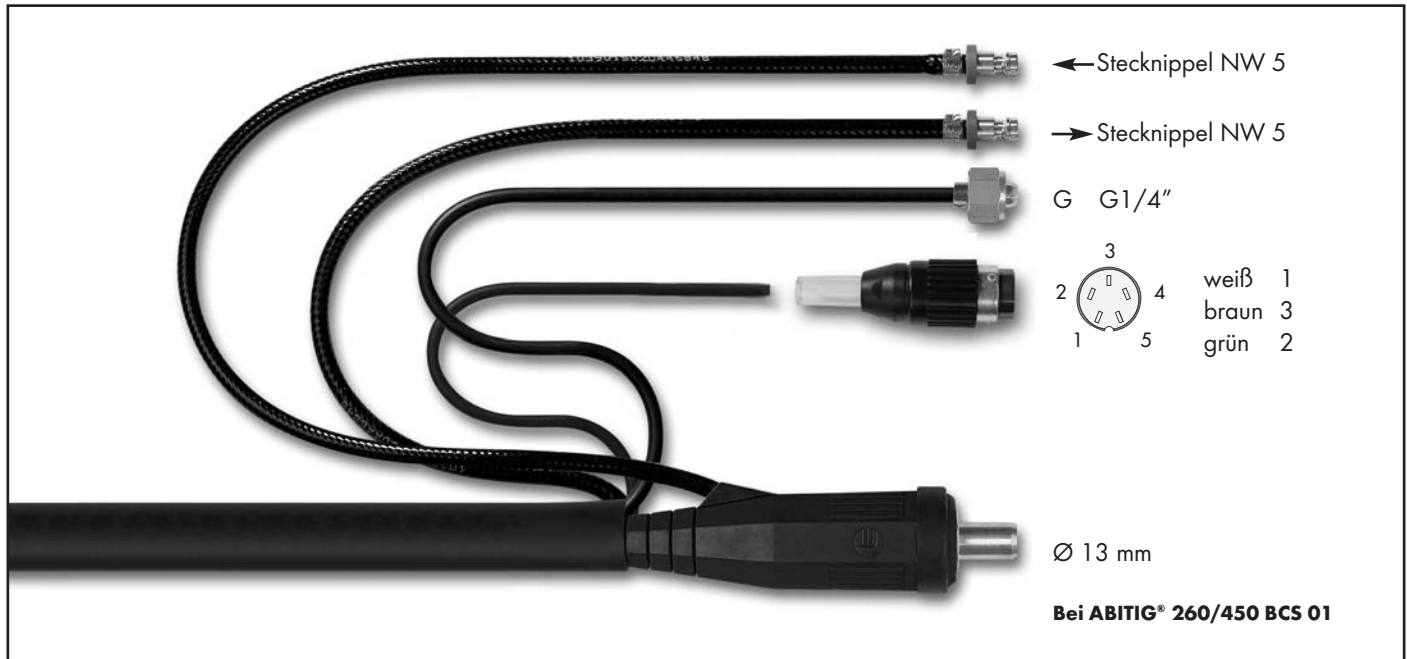

Brennertyp	Länge	Schalterfunktion	maschinenseitiger Anschluss	Schlauchpaketausführung	Bestellnummer
ABITIG® 18	4 m	DD	BSB 35-50 Tuchel 5-pol.	Standard	7S4SK043020001B11
	8 m	DD	BSB 35-50 Tuchel 5-pol.	Standard	7S4SK083020001B11
	4 m	DD	BSB 35-50 Tuchel 5-pol.	High Flex Leder	7S4SH043020001B11
	8 m	DD	BSB 35-50 Tuchel 5-pol.	High Flex Leder	7S4SH083020001B11
ABITIG® 18F	4 m	DD	BSB 35-50 Tuchel 5-pol.	Standard	7S4FK043020001B11
	8 m	DD	BSB 35-50 Tuchel 5-pol.	Standard	7S4FK083020001B11
	4 m	DD	BSB 35-50 Tuchel 5-pol.	High Flex Leder	7S4FH043020001B11
	8 m	DD	BSB 35-50 Tuchel 5-pol.	High Flex Leder	7S4FH083020001B11
ABITIG® 20	4 m	DD	BSB 35-50 Tuchel 5-pol.	Standard	7S5SK043020001B11
	8 m	DD	BSB 35-50 Tuchel 5-pol.	Standard	7S5SK083020001B11
	4 m	DD	BSB 35-50 Tuchel 5-pol.	High Flex Leder	7S5SH043020001B11
	8 m	DD	BSB 35-50 Tuchel 5-pol.	High Flex Leder	7S5SH083020001B11
ABITIG® 20F	4 m	DD	BSB 35-50 Tuchel 5-pol.	Standard	7S5FK043020001B11
	8 m	DD	BSB 35-50 Tuchel 5-pol.	Standard	7S5FK083020001B11
	4 m	DD	BSB 35-50 Tuchel 5-pol.	High Flex Leder	7S5FH043020001B11
	8 m	DD	BSB 35-50 Tuchel 5-pol.	High Flex Leder	7S5FH083020001B11

Technische Änderungen vorbehalten • Verkaufspreise = unverbindliche Preisempfehlung - Angebot freibleibend • © Copyright

ABITIG®-Brennerpreisliste

passend für WIG-Stromquellen des Fabrikates „lincoln/norweld“

Brennertyp	Länge	Schalterfunktion	maschinenseitiger Anschluss	Schlauchpaketausführung	Bestellnummer
ABITIG® 12-1	4 m	DD	BSB 35-50 Tuchel 5-pol.	Standard	7S6SK043020001B11
	8 m	DD	BSB 35-50 Tuchel 5-pol.	Standard	7S6SK083020001B11
	4 m	DD	BSB 35-50 Tuchel 5-pol.	High Flex Leder	7S6SH043020001B11
	8 m	DD	BSB 35-50 Tuchel 5-pol.	High Flex Leder	7S6SH083020001B11
<hr/>					
ABITIG® 18SC	4 m	DD	BSB 35-50 Tuchel 5-pol.	Standard	7S7SK043020001B11
	8 m	DD	BSB 35-50 Tuchel 5-pol.	Standard	7S7SK083020001B11
	4 m	DD	BSB 35-50 Tuchel 5-pol.	High Flex Leder	7S7SH043020001B11
	8 m	DD	BSB 35-50 Tuchel 5-pol.	High Flex Leder	7S7SH083020001B11
<hr/>					
ABITIG® 24W	4 m	DD	BSB 35-50 Tuchel 5-pol.	Standard	7S9SK043020001B11
	8 m	DD	BSB 35-50 Tuchel 5-pol.	Standard	7S9SK083020001B11
	4 m	DD	BSB 35-50 Tuchel 5-pol.	High Flex Leder	7S9SH043020001B11
	8 m	DD	BSB 35-50 Tuchel 5-pol.	High Flex Leder	7S9SH083020001B11
<hr/>					
ABITIG® 450W	4 m	DD	BSB 35-50 Tuchel 5-pol.	Standard	7T5SK043020101B11
	8 m	DD	BSB 35-50 Tuchel 5-pol.	Standard	7T5SK083020101B11
	4 m	DD	BSB 35-50 Tuchel 5-pol.	High Flex Leder	7T5SH043020101B11
	8 m	DD	BSB 35-50 Tuchel 5-pol.	High Flex Leder	7T5SH083020101B11
<hr/>					
ABITIG® 260W	4 m	DD	BSB 35-50 Tuchel 5-pol.	Standard	7T7SK043020101B11
	8 m	DD	BSB 35-50 Tuchel 5-pol.	Standard	7T7SK083020101B11
	4 m	DD	BSB 35-50 Tuchel 5-pol.	High Flex Leder	7T7SH043020101B11
	8 m	DD	BSB 35-50 Tuchel 5-pol.	High Flex Leder	7T7SH083020101B11
<hr/>					
ABITIG® 450W SC	4 m	DD	BSB 35-50 Tuchel 5-pol.	Standard	
	8 m	DD	BSB 35-50 Tuchel 5-pol.	Standard	
	4 m	DD	BSB 35-50 Tuchel 5-pol.	High Flex Leder	7T8SH043020101B11
	8 m	DD	BSB 35-50 Tuchel 5-pol.	High Flex Leder	7T8SH083020101B11

ABITIG®-Brennerpreisliste

passend für WIG-Stromquellen des Fabrikates „lorch“



Brennertyp	Länge	Schalterfunktion	maschinenseitiger Anschluss	Schlauchpaketausführung	Bestellnummer
ABITIG® 9	4 m	DD	BSB 35-50 Tuchel 5-pol.	Standard	7S1SK043020002B05
	8 m	DD	BSB 35-50 Tuchel 5-pol.	Standard	7S1SK083020002B05
	4 m	DD	BSB 35-50 Tuchel 5-pol.	High Flex Leder	7S1SH043020002B05
	8 m	DD	BSB 35-50 Tuchel 5-pol.	High Flex Leder	7S1SH083020002B05
ABITIG® 9F	4 m	DD	BSB 35-50 Tuchel 5-pol.	Standard	7S1FK043020002B05
	8 m	DD	BSB 35-50 Tuchel 5-pol.	Standard	7S1FK083020002B05
	4 m	DD	BSB 35-50 Tuchel 5-pol.	High Flex Leder	7S1FH043020002B05
	8 m	DD	BSB 35-50 Tuchel 5-pol.	High Flex Leder	7S1FH083020002B05
ABITIG® 17	4 m	DD	BSB 35-50 Tuchel 5-pol.	Standard	7S2SK043020002B05
	8 m	DD	BSB 35-50 Tuchel 5-pol.	Standard	7S2SK083020002B05
	4 m	DD	BSB 35-50 Tuchel 5-pol.	High Flex Leder	7S2SH043020002B05
	8 m	DD	BSB 35-50 Tuchel 5-pol.	High Flex Leder	7S2SH083020002B05
ABITIG® 17F	4 m	DD	BSB 35-50 Tuchel 5-pol.	Standard	7S2FK043020002B05
	8 m	DD	BSB 35-50 Tuchel 5-pol.	Standard	7S2FK083020002B05
	4 m	DD	BSB 35-50 Tuchel 5-pol.	High Flex Leder	7S2FH043020002B05
	8 m	DD	BSB 35-50 Tuchel 5-pol.	High Flex Leder	7S2FH083020002B05

ABITIG®-Brennerpreisliste

passend für WIG-Stromquellen des Fabrikates „lorch“

Brennertyp	Länge	Schalterfunktion	maschinenseitiger Anschluss	Schlauchpaketausführung	Bestellnummer
ABITIG® 26	4 m	DD	BSB 35-50 Tuchel 5-pol.	Standard	7S3SK043020002B05
	8 m	DD	BSB 35-50 Tuchel 5-pol.	Standard	7S3SK083020002B05
	4 m	DD	BSB 35-50 Tuchel 5-pol.	High Flex Leder	7S3SH043020002B05
	8 m	DD	BSB 35-50 Tuchel 5-pol.	High Flex Leder	7S3SH083020002B05
ABITIG® 26F	4 m	DD	BSB 35-50 Tuchel 5-pol.	Standard	7S3FK043020002B05
	8 m	DD	BSB 35-50 Tuchel 5-pol.	Standard	7S3FK083020002B05
	4 m	DD	BSB 35-50 Tuchel 5-pol.	High Flex Leder	7S3FH043020002B05
	8 m	DD	BSB 35-50 Tuchel 5-pol.	High Flex Leder	7S3FH083020002B05
ABITIG® 24G	4 m	DD	BSB 35-50 Tuchel 5-pol.	Standard	7S8SK043020002B05
	8 m	DD	BSB 35-50 Tuchel 5-pol.	Standard	7S8SK083020002B05
	4 m	DD	BSB 35-50 Tuchel 5-pol.	High Flex Leder	7S8SH043020002B05
	8 m	DD	BSB 35-50 Tuchel 5-pol.	High Flex Leder	7S8SH083020002B05
ABITIG® 200	4 m	DD	BSB 35-50 Tuchel 5-pol.	Standard	7T4SK043020002B05
	8 m	DD	BSB 35-50 Tuchel 5-pol.	Standard	7T4SK083020002B05
	4 m	DD	BSB 35-50 Tuchel 5-pol.	High Flex Leder	7T4SH043020002B05
	8 m	DD	BSB 35-50 Tuchel 5-pol.	High Flex Leder	7T4SH083020002B05
ABITIG® 200F	4 m	DD	BSB 35-50 Tuchel 5-pol.	Standard	7T4FK043020002B05
	8 m	DD	BSB 35-50 Tuchel 5-pol.	Standard	7T4FK083020002B05
	4 m	DD	BSB 35-50 Tuchel 5-pol.	High Flex Leder	7T4FH043020002B05
	8 m	DD	BSB 35-50 Tuchel 5-pol.	High Flex Leder	7T4FH083020002B05
ABITIG® 150	4 m	DD	BSB 35-50 Tuchel 5-pol.	Standard	7T6SK043020002B05
	8 m	DD	BSB 35-50 Tuchel 5-pol.	Standard	7T6SK083020002B05
	4 m	DD	BSB 35-50 Tuchel 5-pol.	High Flex Leder	7T6SH043020002B05
	8 m	DD	BSB 35-50 Tuchel 5-pol.	High Flex Leder	7T6SH083020002B05
ABITIG® 150F	4 m	DD	BSB 35-50 Tuchel 5-pol.	Standard	7T6FK043020002B05
	8 m	DD	BSB 35-50 Tuchel 5-pol.	Standard	7T6FK083020002B05
	4 m	DD	BSB 35-50 Tuchel 5-pol.	High Flex Leder	7T6FH043020002B05
	8 m	DD	BSB 35-50 Tuchel 5-pol.	High Flex Leder	7T6FH083020002B05

ABITIG®-Brennerpreisliste

passend für WIG-Stromquellen des Fabrikates „lorch“



Brennertyp	Länge	Schalterfunktion	maschinenseitiger Anschluss	Schlauchpaketausführung	Bestellnummer
ABITIG® 9	4 m	ED/DD	ZA - WTG-5	Standard	7S1SK043020498A00
	8 m	ED/DD	ZA - WTG-5	Standard	7S1SK083020498A00
	4 m	ED/DD	ZA - WTG-5	High Flex Leder	7S1SH043020498A00
	8 m	ED/DD	ZA - WTG-5	High Flex Leder	7S1SH083020498A00

ABITIG® 9F	4 m	ED/DD	ZA - WTG-5	Standard	7S1FK043020498A00
	8 m	ED/DD	ZA - WTG-5	Standard	7S1FK083020498A00
	4 m	ED/DD	ZA - WTG-5	High Flex Leder	7S1FH043020498A00
	8 m	ED/DD	ZA - WTG-5	High Flex Leder	7S1FH083020498A00

ABITIG® 17	4 m	ED/DD	ZA - WTG-5	Standard	7S2SK043020498A00
	8 m	ED/DD	ZA - WTG-5	Standard	7S2SK083020498A00
	4 m	ED/DD	ZA - WTG-5	High Flex Leder	7S2SH043020498A00
	8 m	ED/DD	ZA - WTG-5	High Flex Leder	7S2SH083020498A00

ABITIG® 17F	4 m	ED/DD	ZA - WTG-5	Standard	7S2FK043020498A00
	8 m	ED/DD	ZA - WTG-5	Standard	7S2FK083020498A00
	4 m	ED/DD	ZA - WTG-5	High Flex Leder	7S2FH043020498A00
	8 m	ED/DD	ZA - WTG-5	High Flex Leder	7S2FH083020498A00

Technische Änderungen vorbehalten • Verkaufspreise = unverbindliche Preisempfehlung - Angebot freibleibend • © Copyright

ABITIG®-Brennerpreisliste

passend für WIG-Stromquellen des Fabrikates „lorch“

Brennertyp	Länge	Schalterfunktion	maschinenseitiger Anschluss	Schlauchpaketausführung	Bestellnummer
ABITIG® 26	4 m	ED/DD	ZA - WTG-5	Standard	7S3SK043020498A00
	8 m	ED/DD	ZA - WTG-5	Standard	7S3SK083020498A00
	4 m	ED/DD	ZA - WTG-5	High Flex Leder	7S3SH043020498A00
	8 m	ED/DD	ZA - WTG-5	High Flex Leder	7S3SH083020498A00
ABITIG® 26F	4 m	ED/DD	ZA - WTG-5	Standard	7S3FK043020498A00
	8 m	ED/DD	ZA - WTG-5	Standard	7S3FK083020498A00
	4 m	ED/DD	ZA - WTG-5	High Flex Leder	7S3FH043020498A00
	8 m	ED/DD	ZA - WTG-5	High Flex Leder	7S3FH083020498A00
ABITIG® 24G	4 m	ED/DD	ZA - WTG-5	Standard	7S8SK043020498A00
	8 m	ED/DD	ZA - WTG-5	Standard	7S8SK083020498A00
	4 m	ED/DD	ZA - WTG-5	High Flex Leder	7S8SH043020498A00
	8 m	ED/DD	ZA - WTG-5	High Flex Leder	7S8SH083020498A00
ABITIG® 200	4 m	ED/DD	ZA - WTG-5	Standard	7T4SK043020498A00
	8 m	ED/DD	ZA - WTG-5	Standard	7T4SK083020498A00
	4 m	ED/DD	ZA - WTG-5	High Flex Leder	7T4SH043020498A00
	8 m	ED/DD	ZA - WTG-5	High Flex Leder	7T4SH083020498A00
ABITIG® 200F	4 m	ED/DD	ZA - WTG-5	Standard	7T4FK043020498A00
	8 m	ED/DD	ZA - WTG-5	Standard	7T4FK083020498A00
	4 m	ED/DD	ZA - WTG-5	High Flex Leder	7T4FH043020498A00
	8 m	ED/DD	ZA - WTG-5	High Flex Leder	7T4FH083020498A00
ABITIG® 150	4 m	ED/DD	ZA - WTG-5	Standard	7T6SK043020498A00
	8 m	ED/DD	ZA - WTG-5	Standard	7T6SK083020498A00
	4 m	ED/DD	ZA - WTG-5	High Flex Leder	7T6SH043020498A00
	8 m	ED/DD	ZA - WTG-5	High Flex Leder	7T6SH083020498A00
ABITIG® 150F	4 m	ED/DD	ZA - WTG-5	Standard	7T6FK043020498A00
	8 m	ED/DD	ZA - WTG-5	Standard	7T6FK083020498A00
	4 m	ED/DD	ZA - WTG-5	High Flex Leder	7T6FH043020498A00
	8 m	ED/DD	ZA - WTG-5	High Flex Leder	7T6FH083020498A00

ABITIG®-Brennerpreisliste

passend für WIG-Stromquellen des Fabrikates „lorch“

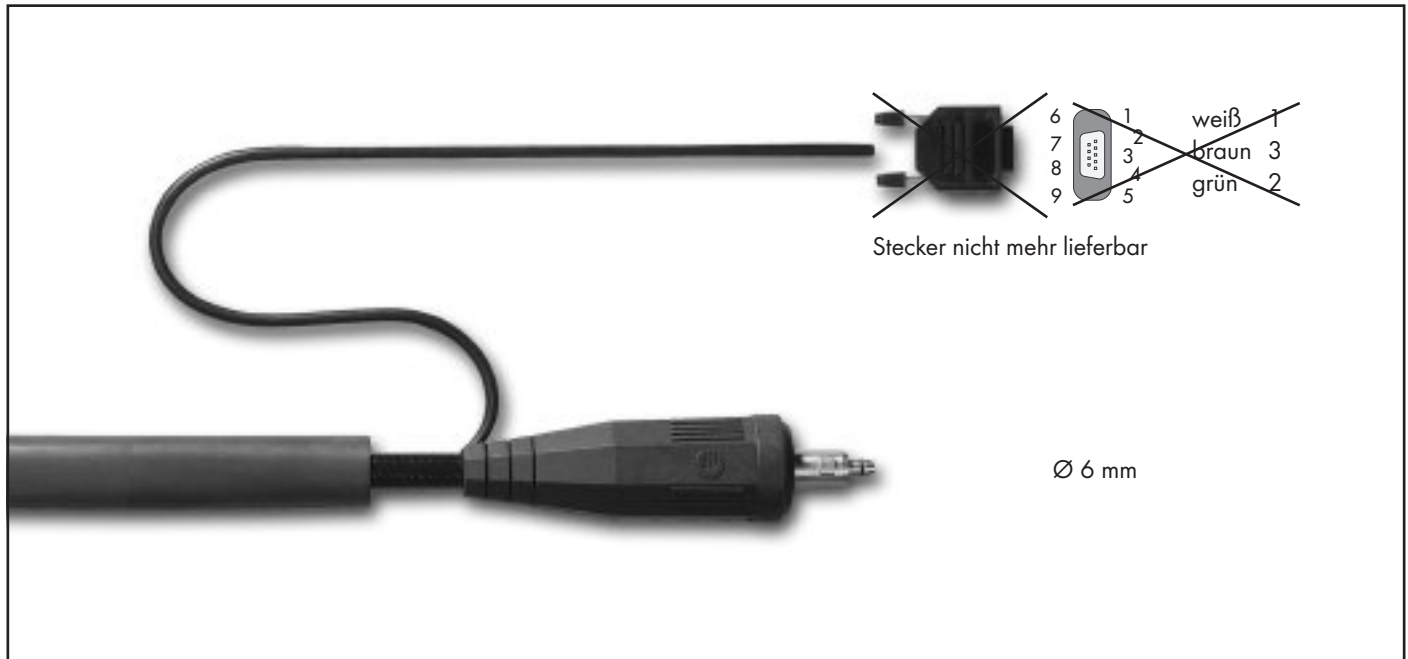

Brennertyp	Länge	Schalterfunktion	maschinenseitiger Anschluss	Schlauchpaketausführung	Bestellnummer
ABITIG® 9	4 m	DD	lorch - BSB / CG offen	Standard	7S1SK043022300000
	8 m	DD	lorch - BSB / CG offen	Standard	7S1SK083022300000
	4 m	DD	lorch - BSB / CG offen	High Flex Leder	7S1SH043022300000
	8 m	DD	lorch - BSB / CG offen	High Flex Leder	7S1SH083022300000

ABITIG® 9F	4 m	DD	lorch - BSB / CG offen	Standard	7S1FK043022300000
	8 m	DD	lorch - BSB / CG offen	Standard	7S1FK083022300000
	4 m	DD	lorch - BSB / CG offen	High Flex Leder	7S1FH043022300000
	8 m	DD	lorch - BSB / CG offen	High Flex Leder	7S1FH083022300000

ABITIG® 17	4 m	DD	lorch - BSB / CG offen	Standard	7S2SK043022300000
	8 m	DD	lorch - BSB / CG offen	Standard	7S2SK083022300000
	4 m	DD	lorch - BSB / CG offen	High Flex Leder	7S2SH043022300000
	8 m	DD	lorch - BSB / CG offen	High Flex Leder	7S2SH083022300000

ABITIG® 17F	4 m	DD	lorch - BSB / CG offen	Standard	7S2FK043022300000
	8 m	DD	lorch - BSB / CG offen	Standard	7S2FK083022300000
	4 m	DD	lorch - BSB / CG offen	High Flex Leder	7S2FH043022300000
	8 m	DD	lorch - BSB / CG offen	High Flex Leder	7S2FH083022300000

Technische Änderungen vorbehalten • Verkaufspreise = unverbindliche Preisempfehlung - Angebot freibleibend • © Copyright

ABITIG®-Brennerpreisliste

passend für WIG-Stromquellen des Fabrikates „lorch“

Brennertyp	Länge	Schalterfunktion	maschinenseitiger Anschluss	Schlauchpaketausführung	Bestellnummer
ABITIG® 26	4 m	DD	lorch - BSB / CG offen	Standard	7S3SK043022300000
	8 m	DD	lorch - BSB / CG offen	Standard	7S3SK083022300000
	4 m	DD	lorch - BSB / CG offen	High Flex Leder	7S3SH043022300000
	8 m	DD	lorch - BSB / CG offen	High Flex Leder	7S3SH083022300000

ABITIG® 26F	4 m	DD	lorch - BSB / CG offen	Standard	7S3FK043022300000
	8 m	DD	lorch - BSB / CG offen	Standard	7S3FK083022300000
	4 m	DD	lorch - BSB / CG offen	High Flex Leder	7S3FH043022300000
	8 m	DD	lorch - BSB / CG offen	High Flex Leder	7S3FH083022300000

ABITIG® 24G	4 m	DD	lorch - BSB / CG offen	Standard	7S8SK043022300000
	8 m	DD	lorch - BSB / CG offen	Standard	7S8SK083022300000
	4 m	DD	lorch - BSB / CG offen	High Flex Leder	7S8SH043022300000
	8 m	DD	lorch - BSB / CG offen	High Flex Leder	7S8SH083022300000

ABITIG® 200	4 m	DD	lorch - BSB / CG offen	Standard	7T4SK043022300000
	8 m	DD	lorch - BSB / CG offen	Standard	7T4SK083022300000
	4 m	DD	lorch - BSB / CG offen	High Flex Leder	7T4SH043022300000
	8 m	DD	lorch - BSB / CG offen	High Flex Leder	7T4SH083022300000

ABITIG® 200F	4 m	DD	lorch - BSB / CG offen	Standard	7T4FK043022300000
	8 m	DD	lorch - BSB / CG offen	Standard	7T4FK083022300000
	4 m	DD	lorch - BSB / CG offen	High Flex Leder	7T4FH043022300000
	8 m	DD	lorch - BSB / CG offen	High Flex Leder	7T4FH083022300000

ABITIG® 150	4 m	DD	lorch - BSB / CG offen	Standard	7T6SK043022300000
	8 m	DD	lorch - BSB / CG offen	Standard	7T6SK083022300000
	4 m	DD	lorch - BSB / CG offen	High Flex Leder	7T6SH043022300000
	8 m	DD	lorch - BSB / CG offen	High Flex Leder	7T6SH083022300000

ABITIG® 150F	4 m	DD	lorch - BSB / CG offen	Standard	7T6FK043022300000
	8 m	DD	lorch - BSB / CG offen	Standard	7T6FK083022300000
	4 m	DD	lorch - BSB / CG offen	High Flex Leder	7T6FH043022300000
	8 m	DD	lorch - BSB / CG offen	High Flex Leder	7T6FH083022300000

ABITIG®-Brennerpreisliste

passend für WIG-Stromquellen des Fabrikates „lorch“

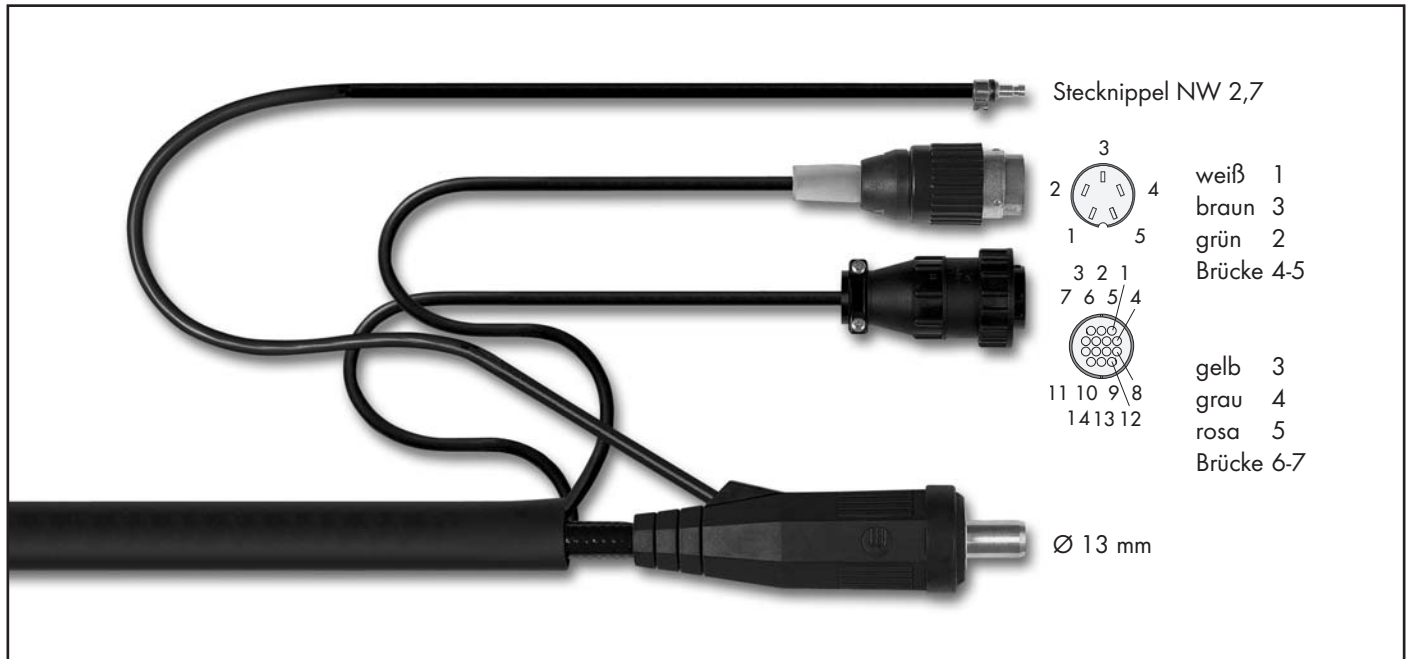

Brennertyp	Länge	Schalterfunktion	maschinenseitiger Anschluss	Schlauchpaketausführung	Bestellnummer
ABITIG® 9	4 m	DDP	BSB 35-50 Tuchel 5-pol.+ AMP 14-pol.	Standard	7S1SK046040036A05
	8 m	DDP	BSB 35-50 Tuchel 5-pol.+ AMP 14-pol.	Standard	7S1SK086040036A05
	4 m	DDP	BSB 35-50 Tuchel 5-pol.+ AMP 14-pol.	High Flex Leder	7S1SH046040036A05
	8 m	DDP	BSB 35-50 Tuchel 5-pol.+ AMP 14-pol.	High Flex Leder	7S1SH086040036A05
ABITIG® 9F	4 m	DDP	BSB 35-50 Tuchel 5-pol.+ AMP 14-pol.	Standard	7S1FK046040036A05
	8 m	DDP	BSB 35-50 Tuchel 5-pol.+ AMP 14-pol.	Standard	7S1FK086040036A05
	4 m	DDP	BSB 35-50 Tuchel 5-pol.+ AMP 14-pol.	High Flex Leder	7S1FH046040036A05
	8 m	DDP	BSB 35-50 Tuchel 5-pol.+ AMP 14-pol.	High Flex Leder	7S1FH086040036A05
ABITIG® 17	4 m	DDP	BSB 35-50 Tuchel 5-pol.+ AMP 14-pol.	Standard	7S2SK046040036A05
	8 m	DDP	BSB 35-50 Tuchel 5-pol.+ AMP 14-pol.	Standard	7S2SK086040036A05
	4 m	DDP	BSB 35-50 Tuchel 5-pol.+ AMP 14-pol.	High Flex Leder	7S2SH046040036A05
	8 m	DDP	BSB 35-50 Tuchel 5-pol.+ AMP 14-pol.	High Flex Leder	7S2SH086040036A05
ABITIG® 17F	4 m	DDP	BSB 35-50 Tuchel 5-pol.+ AMP 14-pol.	Standard	7S2FK046040036A05
	8 m	DDP	BSB 35-50 Tuchel 5-pol.+ AMP 14-pol.	Standard	7S2FK086040036A05
	4 m	DDP	BSB 35-50 Tuchel 5-pol.+ AMP 14-pol.	High Flex Leder	7S2FH046040036A05
	8 m	DDP	BSB 35-50 Tuchel 5-pol.+ AMP 14-pol.	High Flex Leder	7S2FH086040036A05

Technische Änderungen vorbehalten • Verkaufspreise = unverbindliche Preisempfehlung - Angebot freibleibend • © Copyright

ABITIG®-Brennerpreisliste

passend für WIG-Stromquellen des Fabrikates „lorch“

Brennertyp	Länge	Schalterfunktion	maschinenseitiger Anschluss	Schlauchpaketausführung	Bestellnummer
ABITIG® 26	4 m	DDP	BSB 35-50 Tuchel 5-pol.+ AMP 14-pol.	Standard	7S3SK046040036A05
	8 m	DDP	BSB 35-50 Tuchel 5-pol.+ AMP 14-pol.	Standard	7S3SK086040036A05
	4 m	DDP	BSB 35-50 Tuchel 5-pol.+ AMP 14-pol.	High Flex Leder	7S3SH046040036A05
	8 m	DDP	BSB 35-50 Tuchel 5-pol.+ AMP 14-pol.	High Flex Leder	7S3SH086040036A05
ABITIG® 26F	4 m	DDP	BSB 35-50 Tuchel 5-pol.+ AMP 14-pol.	Standard	7S3FK046040036A05
	8 m	DDP	BSB 35-50 Tuchel 5-pol.+ AMP 14-pol.	Standard	7S3FK086040036A05
	4 m	DDP	BSB 35-50 Tuchel 5-pol.+ AMP 14-pol.	High Flex Leder	7S3FH046040036A05
	8 m	DDP	BSB 35-50 Tuchel 5-pol.+ AMP 14-pol.	High Flex Leder	7S3FH086040036A05
ABITIG® 24G	4 m	DDP	BSB 35-50 Tuchel 5-pol.+ AMP 14-pol.	Standard	7S8SK046040036A05
	8 m	DDP	BSB 35-50 Tuchel 5-pol.+ AMP 14-pol.	Standard	7S8SK086040036A05
	4 m	DDP	BSB 35-50 Tuchel 5-pol.+ AMP 14-pol.	High Flex Leder	7S8SH046040036A05
	8 m	DDP	BSB 35-50 Tuchel 5-pol.+ AMP 14-pol.	High Flex Leder	7S8SH086040036A05
ABITIG® 200	4 m	DDP	BSB 35-50 Tuchel 5-pol.+ AMP 14-pol.	Standard	7T4SK046040036A05
	8 m	DDP	BSB 35-50 Tuchel 5-pol.+ AMP 14-pol.	Standard	7T4SK086040036A05
	4 m	DDP	BSB 35-50 Tuchel 5-pol.+ AMP 14-pol.	High Flex Leder	7T4SH046040036A05
	8 m	DDP	BSB 35-50 Tuchel 5-pol.+ AMP 14-pol.	High Flex Leder	7T4SH086040036A05
ABITIG® 200F	4 m	DDP	BSB 35-50 Tuchel 5-pol.+ AMP 14-pol.	Standard	7T4FK046040036A05
	8 m	DDP	BSB 35-50 Tuchel 5-pol.+ AMP 14-pol.	Standard	7T4FK086040036A05
	4 m	DDP	BSB 35-50 Tuchel 5-pol.+ AMP 14-pol.	High Flex Leder	7T4FH046040036A05
	8 m	DDP	BSB 35-50 Tuchel 5-pol.+ AMP 14-pol.	High Flex Leder	7T4FH086040036A05
ABITIG® 150	4 m	DDP	BSB 35-50 Tuchel 5-pol.+ AMP 14-pol.	Standard	7T6SK046040036A05
	8 m	DDP	BSB 35-50 Tuchel 5-pol.+ AMP 14-pol.	Standard	7T6SK086040036A05
	4 m	DDP	BSB 35-50 Tuchel 5-pol.+ AMP 14-pol.	High Flex Leder	7T6SH046040036A05
	8 m	DDP	BSB 35-50 Tuchel 5-pol.+ AMP 14-pol.	High Flex Leder	7T6SH086040036A05
ABITIG® 150F	4 m	DDP	BSB 35-50 Tuchel 5-pol.+ AMP 14-pol.	Standard	7T6FK046040036A05
	8 m	DDP	BSB 35-50 Tuchel 5-pol.+ AMP 14-pol.	Standard	7T6FK086040036A05
	4 m	DDP	BSB 35-50 Tuchel 5-pol.+ AMP 14-pol.	High Flex Leder	7T6FH046040036A05
	8 m	DDP	BSB 35-50 Tuchel 5-pol.+ AMP 14-pol.	High Flex Leder	7T6FH086040036A05

ABITIG®-Brennerpreisliste

passend für WIG-Stromquellen des Fabrikates „lorch“



Brennertyp	Länge	Schalterfunktion	maschinenseitiger Anschluss	Schlauchpaketausführung	Bestellnummer
ABITIG® 9	4 m	ED	MAG - ZA	Standard	7S1SK043013496A00
	8 m	ED	MAG - ZA	Standard	7S1SK083013496A00
	4 m	ED	MAG - ZA	High Flex Leder	7S1SH043013496A00
	8 m	ED	MAG - ZA	High Flex Leder	7S1SH083013496A00
ABITIG® 9F	4 m	ED	MAG - ZA	Standard	7S1FK043013496A00
	8 m	ED	MAG - ZA	Standard	7S1FK083013496A00
	4 m	ED	MAG - ZA	High Flex Leder	7S1FH043013496A00
	8 m	ED	MAG - ZA	High Flex Leder	7S1FH083013496A00
ABITIG® 17	4 m	ED	MAG - ZA	Standard	7S2SK043013496A00
	8 m	ED	MAG - ZA	Standard	7S2SK083013496A00
	4 m	ED	MAG - ZA	High Flex Leder	7S2SH043013496A00
	8 m	ED	MAG - ZA	High Flex Leder	7S2SH083013496A00
ABITIG® 17F	4 m	ED	MAG - ZA	Standard	7S2FK043013496A00
	8 m	ED	MAG - ZA	Standard	7S2FK083013496A00
	4 m	ED	MAG - ZA	High Flex Leder	7S2FH043013496A00
	8 m	ED	MAG - ZA	High Flex Leder	7S2FH083013496A00

Technische Änderungen vorbehalten • Verkaufspreise = unverbindliche Preisempfehlung - Angebot freibleibend • © Copyright

ABITIG®-Brennerpreisliste

passend für WIG-Stromquellen des Fabrikates „lorch“

Brennertyp	Länge	Schalterfunktion	maschinenseitiger Anschluss	Schlauchpaketausführung	Bestellnummer
ABITIG® 26	4 m	ED	MAG - ZA	Standard	7S3SK043013496A00
	8 m	ED	MAG - ZA	Standard	7S3SK083013496A00
	4 m	ED	MAG - ZA	High Flex Leder	7S3SH043013496A00
	8 m	ED	MAG - ZA	High Flex Leder	7S3SH083013496A00
ABITIG® 26F	4 m	ED	MAG - ZA	Standard	7S3FK043013496A00
	8 m	ED	MAG - ZA	Standard	7S3FK083013496A00
	4 m	ED	MAG - ZA	High Flex Leder	7S3FH043013496A00
	8 m	ED	MAG - ZA	High Flex Leder	7S3FH083013496A00
ABITIG® 24G	4 m	ED	MAG - ZA	Standard	7S8SK043013496A00
	8 m	ED	MAG - ZA	Standard	7S8SK083013496A00
	4 m	ED	MAG - ZA	High Flex Leder	7S8SH043013496A00
	8 m	ED	MAG - ZA	High Flex Leder	7S8SH083013496A00
ABITIG® 200	4 m	ED	MAG - ZA	Standard	7T4SK043013496A00
	8 m	ED	MAG - ZA	Standard	7T4SK083013496A00
	4 m	ED	MAG - ZA	High Flex Leder	7T4SH043013496A00
	8 m	ED	MAG - ZA	High Flex Leder	7T4SH083013496A00
ABITIG® 200F	4 m	ED	MAG - ZA	Standard	7T4FK043013496A00
	8 m	ED	MAG - ZA	Standard	7T4FK083013496A00
	4 m	ED	MAG - ZA	High Flex Leder	7T4FH043013496A00
	8 m	ED	MAG - ZA	High Flex Leder	7T4FH083013496A00
ABITIG® 150	4 m	ED	MAG - ZA	Standard	7T6SK043013496A00
	8 m	ED	MAG - ZA	Standard	7T6SK083013496A00
	4 m	ED	MAG - ZA	High Flex Leder	7T6SH043013496A00
	8 m	ED	MAG - ZA	High Flex Leder	7T6SH083013496A00
ABITIG® 150F	4 m	ED	MAG - ZA	Standard	7T6FK043013496A00
	8 m	ED	MAG - ZA	Standard	7T6FK083013496A00
	4 m	ED	MAG - ZA	High Flex Leder	7T6FH043013496A00
	8 m	ED	MAG - ZA	High Flex Leder	7T6FH083013496A00

ABITIG®-Brennerpreisliste

passend für WIG-Stromquellen des Fabrikates „lorch“

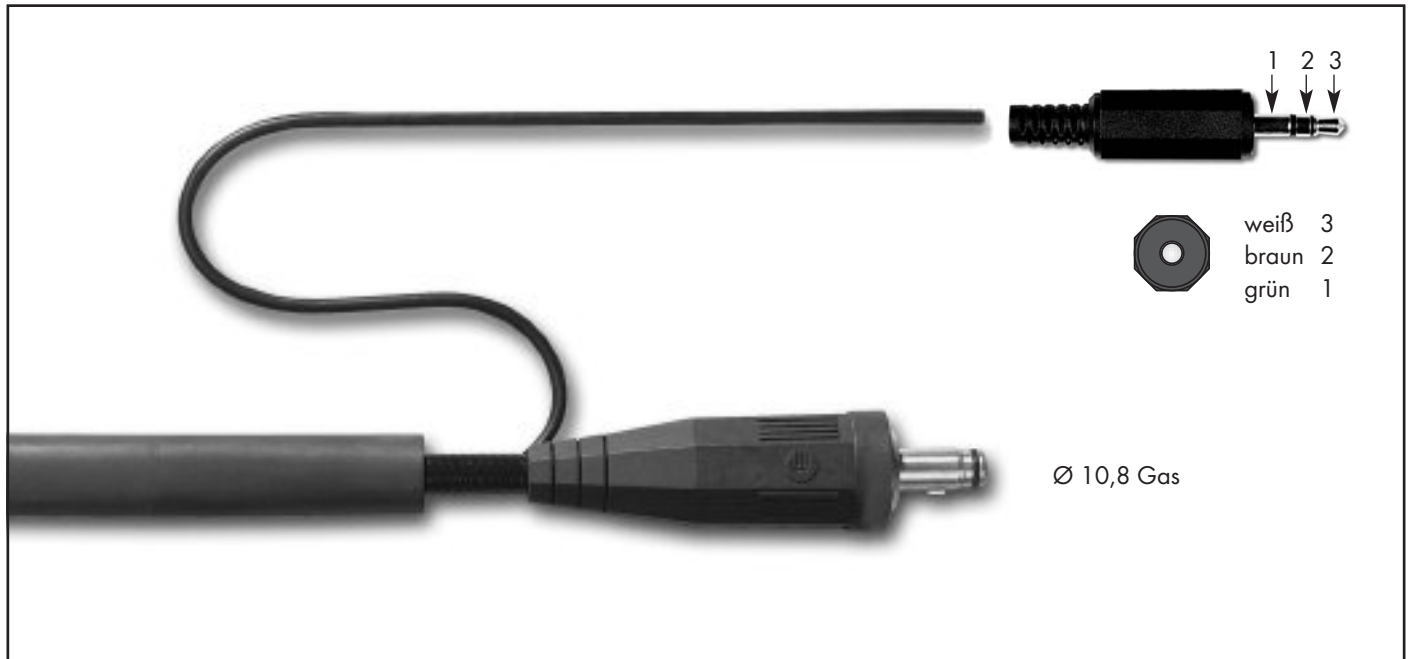

Brennertyp	Länge	Schalterfunktion	maschinenseitiger Anschluss	Schlauchpaketausführung	Bestellnummer
ABITIG® 9	4 m	DD	BSB CG/3-pol. Stecker	Standard	7S1SK043023859A00
	8 m	DD	BSB CG/3-pol. Stecker	Standard	7S1SK083023859A00
	4 m	DD	BSB CG/3-pol. Stecker	High Flex Leder	7S1SH043023859A00
	8 m	DD	BSB CG/3-pol. Stecker	High Flex Leder	7S1SH083023859A00

ABITIG® 9F	4 m	DD	BSB CG/3-pol. Stecker	Standard	7S1FK043023859A00
	8 m	DD	BSB CG/3-pol. Stecker	Standard	7S1FK083023859A00
	4 m	DD	BSB CG/3-pol. Stecker	High Flex Leder	7S1FH043023859A00
	8 m	DD	BSB CG/3-pol. Stecker	High Flex Leder	7S1FH083023859A00

ABITIG® 17	4 m	DD	BSB CG/3-pol. Stecker	Standard	7S2SK043023859A00
	8 m	DD	BSB CG/3-pol. Stecker	Standard	7S2SK083023859A00
	4 m	DD	BSB CG/3-pol. Stecker	High Flex Leder	7S2SH043023859A00
	8 m	DD	BSB CG/3-pol. Stecker	High Flex Leder	7S2SH083023859A00

ABITIG® 17F	4 m	DD	BSB CG/3-pol. Stecker	Standard	7S2FK043023859A00
	8 m	DD	BSB CG/3-pol. Stecker	Standard	7S2FK083023859A00
	4 m	DD	BSB CG/3-pol. Stecker	High Flex Leder	7S2FH043023859A00
	8 m	DD	BSB CG/3-pol. Stecker	High Flex Leder	7S2FH083023859A00

Technische Änderungen vorbehalten • Verkaufspreise = unverbindliche Preisempfehlung - Angebot freibleibend • © Copyright

ABITIG®-Brennerpreisliste

passend für WIG-Stromquellen des Fabrikates „lorch“

Brennertyp	Länge	Schalterfunktion	maschinenseitiger Anschluss	Schlauchpaketausführung	Bestellnummer
ABITIG® 26	4 m	DD	BSB CG/3-pol. Stecker	Standard	7S3SK043023859A00
	8 m	DD	BSB CG/3-pol. Stecker	Standard	7S3SK083023859A00
	4 m	DD	BSB CG/3-pol. Stecker	High Flex Leder	7S3SH043023859A00
	8 m	DD	BSB CG/3-pol. Stecker	High Flex Leder	7S3SH083023859A00

ABITIG® 26F	4 m	DD	BSB CG/3-pol. Stecker	Standard	7S3FK043023859A00
	8 m	DD	BSB CG/3-pol. Stecker	Standard	7S3FK083023859A00
	4 m	DD	BSB CG/3-pol. Stecker	High Flex Leder	7S3FH043023859A00
	8 m	DD	BSB CG/3-pol. Stecker	High Flex Leder	7S3FH083023859A00

ABITIG® 24G	4 m	DD	BSB CG/3-pol. Stecker	Standard	7S8SK043023859A00
	8 m	DD	BSB CG/3-pol. Stecker	Standard	7S8SK083023859A00
	4 m	DD	BSB CG/3-pol. Stecker	High Flex Leder	7S8SH043023859A00
	8 m	DD	BSB CG/3-pol. Stecker	High Flex Leder	7S8SH083023859A00

ABITIG® 200	4 m	DD	BSB CG/3-pol. Stecker	Standard	7T4SK043023859A00
	8 m	DD	BSB CG/3-pol. Stecker	Standard	7T4SK083023859A00
	4 m	DD	BSB CG/3-pol. Stecker	High Flex Leder	7T4SH043023859A00
	8 m	DD	BSB CG/3-pol. Stecker	High Flex Leder	7T4SH083023859A00

ABITIG® 200F	4 m	DD	BSB CG/3-pol. Stecker	Standard	7T4FK043023859A00
	8 m	DD	BSB CG/3-pol. Stecker	Standard	7T4FK083023859A00
	4 m	DD	BSB CG/3-pol. Stecker	High Flex Leder	7T4FH043023859A00
	8 m	DD	BSB CG/3-pol. Stecker	High Flex Leder	7T4FH083023859A00

ABITIG® 150	4 m	DD	BSB CG/3-pol. Stecker	Standard	7T6SK043023859A00
	8 m	DD	BSB CG/3-pol. Stecker	Standard	7T6SK083023859A00
	4 m	DD	BSB CG/3-pol. Stecker	High Flex Leder	7T6SH043023859A00
	8 m	DD	BSB CG/3-pol. Stecker	High Flex Leder	7T6SH083023859A00

ABITIG® 150F	4 m	DD	BSB CG/3-pol. Stecker	Standard	7T6FK043023859A00
	8 m	DD	BSB CG/3-pol. Stecker	Standard	7T6FK083023859A00
	4 m	DD	BSB CG/3-pol. Stecker	High Flex Leder	7T6FH043023859A00
	8 m	DD	BSB CG/3-pol. Stecker	High Flex Leder	7T6FH083023859A00

ABITIG®-Brennerpreisliste

passend für WIG-Stromquellen des Fabrikates „lorch“



Brennertyp	Länge	Schalterfunktion	maschinenseitiger Anschluss	Schlauchpaketausführung	Bestellnummer
ABITIG® 9	4 m	UD	BSB 35-50 Tuchel 5 pol.	Standard	7S1SK046450051A05
	8 m	UD	BSB 35-50 Tuchel 5 pol.	Standard	7S1SK086450051A05
	4 m	UD	BSB 35-50 Tuchel 5 pol.	High Flex Leder	7S1SH046450051A05
	8 m	UD	BSB 35-50 Tuchel 5 pol.	High Flex Leder	7S1SH086450051A05

ABITIG® 9F	4 m	UD	BSB 35-50 Tuchel 5 pol.	Standard	7S1FK046450051A05
	8 m	UD	BSB 35-50 Tuchel 5 pol.	Standard	7S1FK086450051A05
	4 m	UD	BSB 35-50 Tuchel 5 pol.	High Flex Leder	7S1FH046450051A05
	8 m	UD	BSB 35-50 Tuchel 5 pol.	High Flex Leder	7S1FH086450051A05

ABITIG® 17	4 m	UD	BSB 35-50 Tuchel 5 pol.	Standard	7S2SK046450051A05
	8 m	UD	BSB 35-50 Tuchel 5 pol.	Standard	7S2SK086450051A05
	4 m	UD	BSB 35-50 Tuchel 5 pol.	High Flex Leder	7S2SH046450051A05
	8 m	UD	BSB 35-50 Tuchel 5 pol.	High Flex Leder	7S2SH086450051A05

ABITIG® 17F	4 m	UD	BSB 35-50 Tuchel 5 pol.	Standard	7S2FK046450051A05
	8 m	UD	BSB 35-50 Tuchel 5 pol.	Standard	7S2FK086450051A05
	4 m	UD	BSB 35-50 Tuchel 5 pol.	High Flex Leder	7S2FH046450051A05
	8 m	UD	BSB 35-50 Tuchel 5 pol.	High Flex Leder	7S2FH086450051A05

Technische Änderungen vorbehalten • Verkaufspreise = unverbindliche Preisempfehlung - Angebot freibleibend • © Copyright

ABITIG®-Brennerpreisliste

passend für WIG-Stromquellen des Fabrikates „lorch“

Brennertyp	Länge	Schalterfunktion	maschinenseitiger Anschluss	Schlauchpaketausführung	Bestellnummer
ABITIG® 26	4 m	UD	BSB 35-50 Tuchel 5 pol.	Standard	7S3SK046450051A05
	8 m	UD	BSB 35-50 Tuchel 5 pol.	Standard	7S3SK086450051A05
	4 m	UD	BSB 35-50 Tuchel 5 pol.	High Flex Leder	7S3SH046450051A05
	8 m	UD	BSB 35-50 Tuchel 5 pol.	High Flex Leder	7S3SH086450051A05
ABITIG® 26F	4 m	UD	BSB 35-50 Tuchel 5 pol.	Standard	7S3FK046450051A05
	8 m	UD	BSB 35-50 Tuchel 5 pol.	Standard	7S3FK086450051A05
	4 m	UD	BSB 35-50 Tuchel 5 pol.	High Flex Leder	7S3FH046450051A05
	8 m	UD	BSB 35-50 Tuchel 5 pol.	High Flex Leder	7S3FH086450051A05
ABITIG® 24G	4 m	UD	BSB 35-50 Tuchel 5 pol.	Standard	7S8SK046450051A05
	8 m	UD	BSB 35-50 Tuchel 5 pol.	Standard	7S8SK086450051A05
	4 m	UD	BSB 35-50 Tuchel 5 pol.	High Flex Leder	7S8SH046450051A05
	8 m	UD	BSB 35-50 Tuchel 5 pol.	High Flex Leder	7S8SH086450051A05
ABITIG® 200	4 m	UD	BSB 35-50 Tuchel 5 pol.	Standard	7T4SK046450051A05
	8 m	UD	BSB 35-50 Tuchel 5 pol.	Standard	7T4SK086450051A05
	4 m	UD	BSB 35-50 Tuchel 5 pol.	High Flex Leder	7T4SH046450051A05
	8 m	UD	BSB 35-50 Tuchel 5 pol.	High Flex Leder	7T4SH086450051A05
ABITIG® 200F	4 m	UD	BSB 35-50 Tuchel 5 pol.	Standard	7T4FK046450051A05
	8 m	UD	BSB 35-50 Tuchel 5 pol.	Standard	7T4FK086450051A05
	4 m	UD	BSB 35-50 Tuchel 5 pol.	High Flex Leder	7T4FH046450051A05
	8 m	UD	BSB 35-50 Tuchel 5 pol.	High Flex Leder	7T4FH086450051A05
ABITIG® 150	4 m	UD	BSB 35-50 Tuchel 5 pol.	Standard	7T6SK046450051A05
	8 m	UD	BSB 35-50 Tuchel 5 pol.	Standard	7T6SK086450051A05
	4 m	UD	BSB 35-50 Tuchel 5 pol.	High Flex Leder	7T6SH046450051A05
	8 m	UD	BSB 35-50 Tuchel 5 pol.	High Flex Leder	7T6SH086450051A05
ABITIG® 150F	4 m	UD	BSB 35-50 Tuchel 5 pol.	Standard	7T6FK046450051A05
	8 m	UD	BSB 35-50 Tuchel 5 pol.	Standard	7T6FK086450051A05
	4 m	UD	BSB 35-50 Tuchel 5 pol.	High Flex Leder	7T6FH046450051A05
	8 m	UD	BSB 35-50 Tuchel 5 pol.	High Flex Leder	7T6FH086450051A05

ABITIG®-Brennerpreisliste

passend für WIG-Stromquellen des Fabrikates „lorch“



Brennertyp	Länge	Schalterfunktion	maschinenseitiger Anschluss	Schlauchpaketausführung	Bestellnummer
ABITIG® 18	4 m	DD	BSB 35-50 Tuchel 5-pol.	Standard	7S4SK043020001B16
	8 m	DD	BSB 35-50 Tuchel 5-pol.	Standard	7S4SK083020001B16
	4 m	DD	BSB 35-50 Tuchel 5-pol.	High Flex Leder	7S4SH043020001B16
	8 m	DD	BSB 35-50 Tuchel 5-pol.	High Flex Leder	7S4SH083020001B16
ABITIG® 18F	4 m	DD	BSB 35-50 Tuchel 5-pol.	Standard	7S4FK043020001B16
	8 m	DD	BSB 35-50 Tuchel 5-pol.	Standard	7S4FK083020001B16
	4 m	DD	BSB 35-50 Tuchel 5-pol.	High Flex Leder	7S4FH043020001B16
	8 m	DD	BSB 35-50 Tuchel 5-pol.	High Flex Leder	7S4FH083020001B16
ABITIG® 20	4 m	DD	BSB 35-50 Tuchel 5-pol.	Standard	7S5SK043020001B16
	8 m	DD	BSB 35-50 Tuchel 5-pol.	Standard	7S5SK083020001B16
	4 m	DD	BSB 35-50 Tuchel 5-pol.	High Flex Leder	7S5SH043020001B16
	8 m	DD	BSB 35-50 Tuchel 5-pol.	High Flex Leder	7S5SH083020001B16
ABITIG® 20F	4 m	DD	BSB 35-50 Tuchel 5-pol.	Standard	7S5FK043020001B16
	8 m	DD	BSB 35-50 Tuchel 5-pol.	Standard	7S5FK083020001B16
	4 m	DD	BSB 35-50 Tuchel 5-pol.	High Flex Leder	7S5FH043020001B16
	8 m	DD	BSB 35-50 Tuchel 5-pol.	High Flex Leder	7S5FH083020001B16

Technische Änderungen vorbehalten • Verkaufspreise = unverbindliche Preisempfehlung - Angebot freibleibend • © Copyright

ABITIG®-Brennerpreisliste

passend für WIG-Stromquellen des Fabrikates „lorch“

Brennertyp	Länge	Schalterfunktion	maschinenseitiger Anschluss	Schlauchpaketausführung	Bestellnummer
ABITIG® 12-1	4 m	DD	BSB 35-50 Tuchel 5-pol.	Standard	7S6SK043020001B16
	8 m	DD	BSB 35-50 Tuchel 5-pol.	Standard	7S6SK083020001B16
	4 m	DD	BSB 35-50 Tuchel 5-pol.	High Flex Leder	7S6SH043020001B16
	8 m	DD	BSB 35-50 Tuchel 5-pol.	High Flex Leder	7S6SH083020001B16
<hr/>					
ABITIG® 18SC	4 m	DD	BSB 35-50 Tuchel 5-pol.	Standard	7S7SK043020001B16
	8 m	DD	BSB 35-50 Tuchel 5-pol.	Standard	7S7SK083020001B16
	4 m	DD	BSB 35-50 Tuchel 5-pol.	High Flex Leder	7S7SH043020001B16
	8 m	DD	BSB 35-50 Tuchel 5-pol.	High Flex Leder	7S7SH083020001B16
<hr/>					
ABITIG® 24W	4 m	DD	BSB 35-50 Tuchel 5-pol.	Standard	7S9SK043020001B16
	8 m	DD	BSB 35-50 Tuchel 5-pol.	Standard	7S9SK083020001B16
	4 m	DD	BSB 35-50 Tuchel 5-pol.	High Flex Leder	7S9SH043020001B16
	8 m	DD	BSB 35-50 Tuchel 5-pol.	High Flex Leder	7S9SH083020001B16
<hr/>					
ABITIG® 450W	4 m	DD	BSB 35-50 Tuchel 5-pol.	Standard	7T5SK043020101B16
	8 m	DD	BSB 35-50 Tuchel 5-pol.	Standard	7T5SK083020101B16
	4 m	DD	BSB 35-50 Tuchel 5-pol.	High Flex Leder	7T5SH043020101B16
	8 m	DD	BSB 35-50 Tuchel 5-pol.	High Flex Leder	7T5SH083020101B16
<hr/>					
ABITIG® 260W	4 m	DD	BSB 35-50 Tuchel 5-pol.	Standard	7T7SK043020101B16
	8 m	DD	BSB 35-50 Tuchel 5-pol.	Standard	7T7SK083020101B16
	4 m	DD	BSB 35-50 Tuchel 5-pol.	High Flex Leder	7T7SH043020101B16
	8 m	DD	BSB 35-50 Tuchel 5-pol.	High Flex Leder	7T7SH083020101B16
<hr/>					
ABITIG® 450W SC	4 m	DD	BSB 35-50 Tuchel 5-pol.	Standard	
	8 m	DD	BSB 35-50 Tuchel 5-pol.	Standard	
	4 m	DD	BSB 35-50 Tuchel 5-pol.	High Flex Leder	7T8SH043020101B16
	8 m	DD	BSB 35-50 Tuchel 5-pol.	High Flex Leder	7T8SH083020101B16

ABITIG®-Brennerpreisliste

passend für WIG-Stromquellen des Fabrikates „lorch“



Brennertyp	Länge	Schalterfunktion	maschinenseitiger Anschluss	Schlauchpaketausführung	Bestellnummer
ABITIG® 18	4 m	ED/DD	ZA - WTW-5	Standard	7S4SK043020498A12
	8 m	ED/DD	ZA - WTW-5	Standard	7S4SK083020498A12
	4 m	ED/DD	ZA - WTW-5	High Flex Leder	7S4SH043020498A12
	8 m	ED/DD	ZA - WTW-5	High Flex Leder	7S4SH083020498A12
ABITIG® 18F	4 m	ED/DD	ZA - WTW-5	Standard	7S4FK043020498A12
	8 m	ED/DD	ZA - WTW-5	Standard	7S4FK083020498A12
	4 m	ED/DD	ZA - WTW-5	High Flex Leder	7S4FH043020498A12
	8 m	ED/DD	ZA - WTW-5	High Flex Leder	7S4FH083020498A12
ABITIG® 20	4 m	ED/DD	ZA - WTW-5	Standard	7S5SK043020498A12
	8 m	ED/DD	ZA - WTW-5	Standard	7S5SK083020498A12
	4 m	ED/DD	ZA - WTW-5	High Flex Leder	7S5SH043020498A12
	8 m	ED/DD	ZA - WTW-5	High Flex Leder	7S5SH083020498A12
ABITIG® 20F	4 m	ED/DD	ZA - WTW-5	Standard	7S5FK043020498A12
	8 m	ED/DD	ZA - WTW-5	Standard	7S5FK083020498A12
	4 m	ED/DD	ZA - WTW-5	High Flex Leder	7S5FH043020498A12
	8 m	ED/DD	ZA - WTW-5	High Flex Leder	7S5FH083020498A12

Technische Änderungen vorbehalten • Verkaufspreise = unverbindliche Preisempfehlung - Angebot freibleibend • © Copyright

ABITIG®-Brennerpreisliste

passend für WIG-Stromquellen des Fabrikates „lorch“

Brennertyp	Länge	Schalterfunktion	maschinenseitiger Anschluss	Schlauchpaketausführung	Bestellnummer
ABITIG® 12-1	4 m	ED/DD	ZA - WTW-5	Standard	7S6SK043020498A12
	8 m	ED/DD	ZA - WTW-5	Standard	7S6SK083020498A12
	4 m	ED/DD	ZA - WTW-5	High Flex Leder	7S6SH043020498A12
	8 m	ED/DD	ZA - WTW-5	High Flex Leder	7S6SH083020498A12

ABITIG® 18SC	4 m	ED/DD	ZA - WTW-5	Standard	7S7SK043020498A12
	8 m	ED/DD	ZA - WTW-5	Standard	7S7SK083020498A12
	4 m	ED/DD	ZA - WTW-5	High Flex Leder	7S7SH043020498A12
	8 m	ED/DD	ZA - WTW-5	High Flex Leder	7S7SH083020498A12

ABITIG® 24W	4 m	ED/DD	ZA - WTW-5	Standard	7S9SK043020498A12
	8 m	ED/DD	ZA - WTW-5	Standard	7S9SK083020498A12
	4 m	ED/DD	ZA - WTW-5	High Flex Leder	7S9SH043020498A12
	8 m	ED/DD	ZA - WTW-5	High Flex Leder	7S9SH083020498A12

ABITIG® 450W	4 m	ED/DD	ZA - WTW-5	Standard	7T5SK043020498A12
	8 m	ED/DD	ZA - WTW-5	Standard	7T5SK083020498A12
	4 m	ED/DD	ZA - WTW-5	High Flex Leder	7T5SH043020498A12
	8 m	ED/DD	ZA - WTW-5	High Flex Leder	7T5SH083020498A12

ABITIG® 260W	4 m	ED/DD	ZA - WTW-5	Standard	7T7SK043020498A12
	8 m	ED/DD	ZA - WTW-5	Standard	7T7SK083020498A12
	4 m	ED/DD	ZA - WTW-5	High Flex Leder	7T7SH043020498A12
	8 m	ED/DD	ZA - WTW-5	High Flex Leder	7T7SH083020498A12

ABITIG® 450W SC	4 m	ED/DD	ZA - WTW-5	Standard	
	8 m	ED/DD	ZA - WTW-5	Standard	
	4 m	ED/DD	ZA - WTW-5	High Flex Leder	7T8SH043020498A12
	8 m	ED/DD	ZA - WTW-5	High Flex Leder	7T8SH083020498A12

ABITIG®-Brennerpreisliste

passend für WIG-Stromquellen des Fabrikates „lorch“



Brennertyp	Länge	Schalterfunktion	maschinenseitiger Anschluss	Schlauchpaketausführung	Bestellnummer
ABITIG® 18	4 m	DD	lorch - BSB / CG offen	Standard	7S4SK043020200012
	8 m	DD	lorch - BSB / CG offen	Standard	7S4SK083020200012
	4 m	DD	lorch - BSB / CG offen	High Flex Leder	7S4SH043020200012
	8 m	DD	lorch - BSB / CG offen	High Flex Leder	7S4SH083020200012
ABITIG® 18F	4 m	DD	lorch - BSB / CG offen	Standard	7S4FK043020200012
	8 m	DD	lorch - BSB / CG offen	Standard	7S4FK083020200012
	4 m	DD	lorch - BSB / CG offen	High Flex Leder	7S4FH043020200012
	8 m	DD	lorch - BSB / CG offen	High Flex Leder	7S4FH083020200012
ABITIG® 20	4 m	DD	lorch - BSB / CG offen	Standard	7S5SK043020200012
	8 m	DD	lorch - BSB / CG offen	Standard	7S5SK083020200012
	4 m	DD	lorch - BSB / CG offen	High Flex Leder	7S5SH043020200012
	8 m	DD	lorch - BSB / CG offen	High Flex Leder	7S5SH083020200012
ABITIG® 20F	4 m	DD	lorch - BSB / CG offen	Standard	7S5FK043020200012
	8 m	DD	lorch - BSB / CG offen	Standard	7S5FK083020200012
	4 m	DD	lorch - BSB / CG offen	High Flex Leder	7S5FH043020200012
	8 m	DD	lorch - BSB / CG offen	High Flex Leder	7S5FH083020200012

Technische Änderungen vorbehalten • Verkaufspreise = unverbindliche Preisempfehlung - Angebot freibleibend • © Copyright

ABITIG®-Brennerpreisliste

passend für WIG-Stromquellen des Fabrikates „lorch“

Brennertyp	Länge	Schalterfunktion	maschinenseitiger Anschluss	Schlauchpaketausführung	Bestellnummer
ABITIG® 12-1	4 m	DD	lorch - BSB / CG offen	Standard	7S6SK043020200012
	8 m	DD	lorch - BSB / CG offen	Standard	7S6SK083020200012
	4 m	DD	lorch - BSB / CG offen	High Flex Leder	7S6SH043020200012
	8 m	DD	lorch - BSB / CG offen	High Flex Leder	7S6SH083020200012
ABITIG® 18SC	4 m	DD	lorch - BSB / CG offen	Standard	7S7SK043020200012
	8 m	DD	lorch - BSB / CG offen	Standard	7S7SK083020200012
	4 m	DD	lorch - BSB / CG offen	High Flex Leder	7S7SH043020200012
	8 m	DD	lorch - BSB / CG offen	High Flex Leder	7S7SH083020200012
ABITIG® 24W	4 m	DD	lorch - BSB / CG offen	Standard	7S9SK043020200012
	8 m	DD	lorch - BSB / CG offen	Standard	7S9SK083020200012
	4 m	DD	lorch - BSB / CG offen	High Flex Leder	7S9SH043020200012
	8 m	DD	lorch - BSB / CG offen	High Flex Leder	7S9SH083020200012
ABITIG® 450W	4 m	DD	lorch - BSB / CG offen	Standard	7T5SK043020200012
	8 m	DD	lorch - BSB / CG offen	Standard	7T5SK083020200012
	4 m	DD	lorch - BSB / CG offen	High Flex Leder	7T5SH043020200012
	8 m	DD	lorch - BSB / CG offen	High Flex Leder	7T5SH083020200012
ABITIG® 260W	4 m	DD	lorch - BSB / CG offen	Standard	7T7SK043020200012
	8 m	DD	lorch - BSB / CG offen	Standard	7T7SK083020200012
	4 m	DD	lorch - BSB / CG offen	High Flex Leder	7T7SH043020200012
	8 m	DD	lorch - BSB / CG offen	High Flex Leder	7T7SH083020200012
ABITIG® 450W SC	4 m	DD	lorch - BSB / CG offen	Standard	
	8 m	DD	lorch - BSB / CG offen	Standard	
	4 m	DD	lorch - BSB / CG offen	High Flex Leder	7T8SH043020200012
	8 m	DD	lorch - BSB / CG offen	High Flex Leder	7T8SH083020200012

ABITIG®-Brennerpreisliste

passend für WIG-Stromquellen des Fabrikates „lorch“

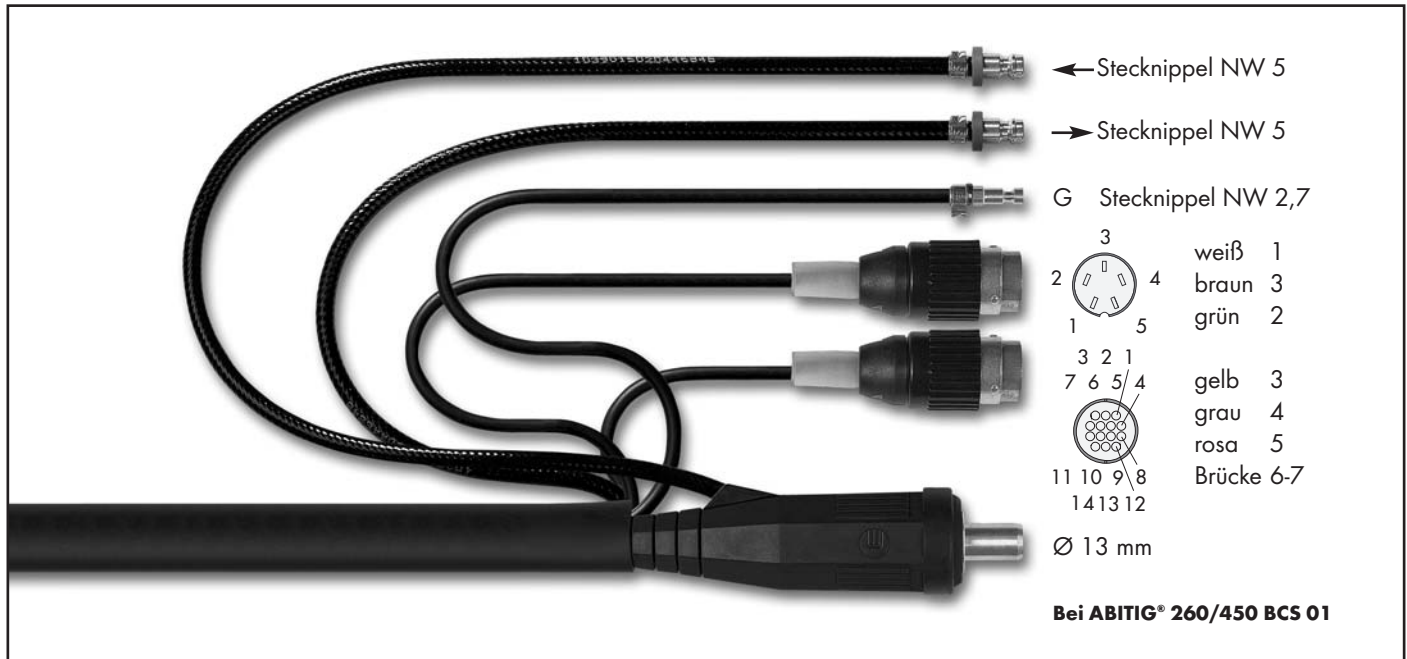

Brennertyp	Länge	Schalterfunktion	maschinenseitiger Anschluss	Schlauchpaketausführung	Bestellnummer
ABITIG® 18	4 m	DDP	BSB 35-50 Tuchel 5-pol.+ AMP 14-pol.	Standard	7S4SK046040036B16
	8 m	DDP	BSB 35-50 Tuchel 5-pol.+ AMP 14-pol.	Standard	7S4SK086040036B16
	4 m	DDP	BSB 35-50 Tuchel 5-pol.+ AMP 14-pol.	High Flex Leder	7S4SH046040036B16
	8 m	DDP	BSB 35-50 Tuchel 5-pol.+ AMP 14-pol.	High Flex Leder	7S4SH086040036B16
ABITIG® 18F	4 m	DDP	BSB 35-50 Tuchel 5-pol.+ AMP 14-pol.	Standard	7S4FK046040036B16
	8 m	DDP	BSB 35-50 Tuchel 5-pol.+ AMP 14-pol.	Standard	7S4FK086040036B16
	4 m	DDP	BSB 35-50 Tuchel 5-pol.+ AMP 14-pol.	High Flex Leder	7S4FH046040036B16
	8 m	DDP	BSB 35-50 Tuchel 5-pol.+ AMP 14-pol.	High Flex Leder	7S4FH086040036B16
ABITIG® 20	4 m	DDP	BSB 35-50 Tuchel 5-pol.+ AMP 14-pol.	Standard	7S5SK046040036B16
	8 m	DDP	BSB 35-50 Tuchel 5-pol.+ AMP 14-pol.	Standard	7S5SK086040036B16
	4 m	DDP	BSB 35-50 Tuchel 5-pol.+ AMP 14-pol.	High Flex Leder	7S5SH046040036B16
	8 m	DDP	BSB 35-50 Tuchel 5-pol.+ AMP 14-pol.	High Flex Leder	7S5SH086040036B16
ABITIG® 20F	4 m	DDP	BSB 35-50 Tuchel 5-pol.+ AMP 14-pol.	Standard	7S5FK046040036B16
	8 m	DDP	BSB 35-50 Tuchel 5-pol.+ AMP 14-pol.	Standard	7S5FK086040036B16
	4 m	DDP	BSB 35-50 Tuchel 5-pol.+ AMP 14-pol.	High Flex Leder	7S5FH046040036B16
	8 m	DDP	BSB 35-50 Tuchel 5-pol.+ AMP 14-pol.	High Flex Leder	7S5FH086040036B16

Technische Änderungen vorbehalten • Verkaufspreise = unverbindliche Preisempfehlung - Angebot freibleibend • © Copyright

ABITIG®-Brennerpreisliste

passend für WIG-Stromquellen des Fabrikates „lorch“

Brennertyp	Länge	Schalterfunktion	maschinenseitiger Anschluss	Schlauchpaketausführung	Bestellnummer
ABITIG® 12-1	4 m	DDP	BSB 35-50 Tuchel 5-pol.+ AMP 14-pol.	Standard	7S6SK046040036B16
	8 m	DDP	BSB 35-50 Tuchel 5-pol.+ AMP 14-pol.	Standard	7S6SK086040036B16
	4 m	DDP	BSB 35-50 Tuchel 5-pol.+ AMP 14-pol.	High Flex Leder	7S6SH046040036B16
	8 m	DDP	BSB 35-50 Tuchel 5-pol.+ AMP 14-pol.	High Flex Leder	7S6SH086040036B16
ABITIG® 18SC	4 m	DDP	BSB 35-50 Tuchel 5-pol.+ AMP 14-pol.	Standard	7S7SK046040036B16
	8 m	DDP	BSB 35-50 Tuchel 5-pol.+ AMP 14-pol.	Standard	7S7SK086040036B16
	4 m	DDP	BSB 35-50 Tuchel 5-pol.+ AMP 14-pol.	High Flex Leder	7S7SH046040036B16
	8 m	DDP	BSB 35-50 Tuchel 5-pol.+ AMP 14-pol.	High Flex Leder	7S7SH086040036B16
ABITIG® 24W	4 m	DDP	BSB 35-50 Tuchel 5-pol.+ AMP 14-pol.	Standard	7S9SK046040036B16
	8 m	DDP	BSB 35-50 Tuchel 5-pol.+ AMP 14-pol.	Standard	7S9SK086040036B16
	4 m	DDP	BSB 35-50 Tuchel 5-pol.+ AMP 14-pol.	High Flex Leder	7S9SH046040036B16
	8 m	DDP	BSB 35-50 Tuchel 5-pol.+ AMP 14-pol.	High Flex Leder	7S9SH086040036B16
ABITIG® 450W	4 m	DDP	BSB 35-50 Tuchel 5-pol.+ AMP 14-pol.	Standard	7T5SK046040136B16
	8 m	DDP	BSB 35-50 Tuchel 5-pol.+ AMP 14-pol.	Standard	7T5SK086040136B16
	4 m	DDP	BSB 35-50 Tuchel 5-pol.+ AMP 14-pol.	High Flex Leder	7T5SH046040136B16
	8 m	DDP	BSB 35-50 Tuchel 5-pol.+ AMP 14-pol.	High Flex Leder	7T5SH086040136B16
ABITIG® 260W	4 m	DDP	BSB 35-50 Tuchel 5-pol.+ AMP 14-pol.	Standard	7T7SK046040136B16
	8 m	DDP	BSB 35-50 Tuchel 5-pol.+ AMP 14-pol.	Standard	7T7SK086040136B16
	4 m	DDP	BSB 35-50 Tuchel 5-pol.+ AMP 14-pol.	High Flex Leder	7T7SH046040136B16
	8 m	DDP	BSB 35-50 Tuchel 5-pol.+ AMP 14-pol.	High Flex Leder	7T7SH086040136B16
ABITIG® 450W SC	4 m	DDP	BSB 35-50 Tuchel 5-pol.+ AMP 14-pol.	Standard	
	8 m	DDP	BSB 35-50 Tuchel 5-pol.+ AMP 14-pol.	Standard	
	4 m	DDP	BSB 35-50 Tuchel 5-pol.+ AMP 14-pol.	High Flex Leder	7T8SH046040136B16
	8 m	DDP	BSB 35-50 Tuchel 5-pol.+ AMP 14-pol.	High Flex Leder	7T8SH086040136B16

ABITIG®-Brennerpreisliste

passend für WIG-Stromquellen des Fabrikates „lorch“



Brennertyp	Länge	Schalterfunktion	maschinenseitiger Anschluss	Schlauchpaketausführung	Bestellnummer
ABITIG® 18	4 m	UD	BSB 35-50 Tuchel 5 pol.	Standard	7S4SK046450051B16
	8 m	UD	BSB 35-50 Tuchel 5 pol.	Standard	7S4SK086450051B16
	4 m	UD	BSB 35-50 Tuchel 5 pol.	High Flex Leder	7S4SH046450051B16
	8 m	UD	BSB 35-50 Tuchel 5 pol.	High Flex Leder	7S4SH086450051B16
ABITIG® 18F	4 m	UD	BSB 35-50 Tuchel 5 pol.	Standard	7S4FK046450051B16
	8 m	UD	BSB 35-50 Tuchel 5 pol.	Standard	7S4FK086450051B16
	4 m	UD	BSB 35-50 Tuchel 5 pol.	High Flex Leder	7S4FH046450051B16
	8 m	UD	BSB 35-50 Tuchel 5 pol.	High Flex Leder	7S4FH086450051B16
ABITIG® 20	4 m	UD	BSB 35-50 Tuchel 5 pol.	Standard	7S5SK046450051B16
	8 m	UD	BSB 35-50 Tuchel 5 pol.	Standard	7S5SK086450051B16
	4 m	UD	BSB 35-50 Tuchel 5 pol.	High Flex Leder	7S5SH046450051B16
	8 m	UD	BSB 35-50 Tuchel 5 pol.	High Flex Leder	7S5SH086450051B16
ABITIG® 20F	4 m	UD	BSB 35-50 Tuchel 5 pol.	Standard	7S5FK046450051B16
	8 m	UD	BSB 35-50 Tuchel 5 pol.	Standard	7S5FK086450051B16
	4 m	UD	BSB 35-50 Tuchel 5 pol.	High Flex Leder	7S5FH046450051B16
	8 m	UD	BSB 35-50 Tuchel 5 pol.	High Flex Leder	7S5FH086450051B16

ABITIG®-Brennerpreisliste

passend für WIG-Stromquellen des Fabrikates „lorch“

Brennertyp	Länge	Schalterfunktion	maschinenseitiger Anschluss	Schlauchpaketausführung	Bestellnummer
ABITIG® 12-1	4 m	UD	BSB 35-50 Tuchel 5 pol.	Standard	7S6SK046450051B16
	8 m	UD	BSB 35-50 Tuchel 5 pol.	Standard	7S6SK086450051B16
	4 m	UD	BSB 35-50 Tuchel 5 pol.	High Flex Leder	7S6SH046450051B16
	8 m	UD	BSB 35-50 Tuchel 5 pol.	High Flex Leder	7S6SH086450051B16

ABITIG® 18SC	4 m	UD	BSB 35-50 Tuchel 5 pol.	Standard	7S7SK046450051B16
	8 m	UD	BSB 35-50 Tuchel 5 pol.	Standard	7S7SK086450051B16
	4 m	UD	BSB 35-50 Tuchel 5 pol.	High Flex Leder	7S7SH046450051B16
	8 m	UD	BSB 35-50 Tuchel 5 pol.	High Flex Leder	7S7SH086450051B16

ABITIG® 24W	4 m	UD	BSB 35-50 Tuchel 5 pol.	Standard	7S9SK046450051B16
	8 m	UD	BSB 35-50 Tuchel 5 pol.	Standard	7S9SK086450051B16
	4 m	UD	BSB 35-50 Tuchel 5 pol.	High Flex Leder	7S9SH046450051B16
	8 m	UD	BSB 35-50 Tuchel 5 pol.	High Flex Leder	7S9SH086450051B16

ABITIG® 450W	4 m	UD	BSB 35-50 Tuchel 5 pol.	Standard	7T5SK046450151B16
	8 m	UD	BSB 35-50 Tuchel 5 pol.	Standard	7T5SK086450151B16
	4 m	UD	BSB 35-50 Tuchel 5 pol.	High Flex Leder	7T5SH046450151B16
	8 m	UD	BSB 35-50 Tuchel 5 pol.	High Flex Leder	7T5SH086450151B16

ABITIG® 260W	4 m	UD	BSB 35-50 Tuchel 5 pol.	Standard	7T7SK046450151B16
	8 m	UD	BSB 35-50 Tuchel 5 pol.	Standard	7T7SK086450151B16
	4 m	UD	BSB 35-50 Tuchel 5 pol.	High Flex Leder	7T7SH046450151B16
	8 m	UD	BSB 35-50 Tuchel 5 pol.	High Flex Leder	7T7SH086450151B16

ABITIG® 450W SC	4 m	UD	BSB 35-50 Tuchel 5 pol.	Standard	
	8 m	UD	BSB 35-50 Tuchel 5 pol.	Standard	
	4 m	UD	BSB 35-50 Tuchel 5 pol.	High Flex Leder	7T8SH046450151B16
	8 m	UD	BSB 35-50 Tuchel 5 pol.	High Flex Leder	7T8SH086450151B16

ABITIG®-Brennerpreisliste

passend für WIG-Stromquellen des Fabrikates „L-tec“



Brennertyp	Länge	Schalterfunktion	maschinenseitiger Anschluss	Schlauchpaketausführung	Bestellnummer
ABITIG® 9	4 m	DD	ZA - GZ Tuchel 5-pol.	Standard	7S1SK047020301C00
	8 m	DD	ZA - GZ Tuchel 5-pol.	Standard	7S1SK087020301C00
	4 m	DD	ZA - GZ Tuchel 5-pol.	High Flex Leder	7S1SH047020301C00
	8 m	DD	ZA - GZ Tuchel 5-pol.	High Flex Leder	7S1SH087020301C00

ABITIG® 9F	4 m	DD	ZA - GZ Tuchel 5-pol.	Standard	7S1FK047020301C00
	8 m	DD	ZA - GZ Tuchel 5-pol.	Standard	7S1FK087020301C00
	4 m	DD	ZA - GZ Tuchel 5-pol.	High Flex Leder	7S1FH047020301C00
	8 m	DD	ZA - GZ Tuchel 5-pol.	High Flex Leder	7S1FH087020301C00

ABITIG® 17	4 m	DD	ZA - GZ Tuchel 5-pol.	Standard	7S2SK047020301C00
	8 m	DD	ZA - GZ Tuchel 5-pol.	Standard	7S2SK087020301C00
	4 m	DD	ZA - GZ Tuchel 5-pol.	High Flex Leder	7S2SH047020301C00
	8 m	DD	ZA - GZ Tuchel 5-pol.	High Flex Leder	7S2SH087020301C00

ABITIG® 17F	4 m	DD	ZA - GZ Tuchel 5-pol.	Standard	7S2FK047020301C00
	8 m	DD	ZA - GZ Tuchel 5-pol.	Standard	7S2FK087020301C00
	4 m	DD	ZA - GZ Tuchel 5-pol.	High Flex Leder	7S2FH047020301C00
	8 m	DD	ZA - GZ Tuchel 5-pol.	High Flex Leder	7S2FH087020301C00

Technische Änderungen vorbehalten • Verkaufspreise = unverbindliche Preisempfehlung - Angebot freibleibend • © Copyright

ABITIG®-Brennerpreisliste

passend für WIG-Stromquellen des Fabrikates „L-tec“

Brennertyp	Länge	Schalterfunktion	maschinenseitiger Anschluss	Schlauchpaketausführung	Bestellnummer
ABITIG® 26	4 m	DD	ZA - GZ Tuchel 5-pol.	Standard	7S3SK047020301C00
	8 m	DD	ZA - GZ Tuchel 5-pol.	Standard	7S3SK087020301C00
	4 m	DD	ZA - GZ Tuchel 5-pol.	High Flex Leder	7S3SH047020301C00
	8 m	DD	ZA - GZ Tuchel 5-pol.	High Flex Leder	7S3SH087020301C00
ABITIG® 26F	4 m	DD	ZA - GZ Tuchel 5-pol.	Standard	7S3FK047020301C00
	8 m	DD	ZA - GZ Tuchel 5-pol.	Standard	7S3FK087020301C00
	4 m	DD	ZA - GZ Tuchel 5-pol.	High Flex Leder	7S3FH047020301C00
	8 m	DD	ZA - GZ Tuchel 5-pol.	High Flex Leder	7S3FH087020301C00
ABITIG® 24G	4 m	DD	ZA - GZ Tuchel 5-pol.	Standard	7S8SK047020301C00
	8 m	DD	ZA - GZ Tuchel 5-pol.	Standard	7S8SK087020301C00
	4 m	DD	ZA - GZ Tuchel 5-pol.	High Flex Leder	7S8SH047020301C00
	8 m	DD	ZA - GZ Tuchel 5-pol.	High Flex Leder	7S8SH087020301C00
ABITIG® 200	4 m	DD	ZA - GZ Tuchel 5-pol.	Standard	7T4SK047020301C00
	8 m	DD	ZA - GZ Tuchel 5-pol.	Standard	7T4SK087020301C00
	4 m	DD	ZA - GZ Tuchel 5-pol.	High Flex Leder	7T4SH047020301C00
	8 m	DD	ZA - GZ Tuchel 5-pol.	High Flex Leder	7T4SH087020301C00
ABITIG® 200F	4 m	DD	ZA - GZ Tuchel 5-pol.	Standard	7T4FK047020301C00
	8 m	DD	ZA - GZ Tuchel 5-pol.	Standard	7T4FK087020301C00
	4 m	DD	ZA - GZ Tuchel 5-pol.	High Flex Leder	7T4FH047020301C00
	8 m	DD	ZA - GZ Tuchel 5-pol.	High Flex Leder	7T4FH087020301C00
ABITIG® 150	4 m	DD	ZA - GZ Tuchel 5-pol.	Standard	7T6SK047020301C00
	8 m	DD	ZA - GZ Tuchel 5-pol.	Standard	7T6SK087020301C00
	4 m	DD	ZA - GZ Tuchel 5-pol.	High Flex Leder	7T6SH047020301C00
	8 m	DD	ZA - GZ Tuchel 5-pol.	High Flex Leder	7T6SH087020301C00
ABITIG® 150F	4 m	DD	ZA - GZ Tuchel 5-pol.	Standard	7T6FK047020301C00
	8 m	DD	ZA - GZ Tuchel 5-pol.	Standard	7T6FK087020301C00
	4 m	DD	ZA - GZ Tuchel 5-pol.	High Flex Leder	7T6FH047020301C00
	8 m	DD	ZA - GZ Tuchel 5-pol.	High Flex Leder	7T6FH087020301C00

ABITIG®-Brennerpreisliste

passend für WIG-Stromquellen des Fabrikates „L-tec“



Brennertyp	Länge	Schalterfunktion	maschinenseitiger Anschluss	Schlauchpaketausführung	Bestellnummer
ABITIG® 9	4 m	ED	ZA - GZ Tuchel 5-pol.	Standard	7S1SK047010306A00
	8 m	ED	ZA - GZ Tuchel 5-pol.	Standard	7S1SK087010306A00
	4 m	ED	ZA - GZ Tuchel 5-pol.	High Flex Leder	7S1SH047010306A00
	8 m	ED	ZA - GZ Tuchel 5-pol.	High Flex Leder	7S1SH087010306A00
ABITIG® 9F	4 m	ED	ZA - GZ Tuchel 5-pol.	Standard	7S1FK047010306A00
	8 m	ED	ZA - GZ Tuchel 5-pol.	Standard	7S1FK087010306A00
	4 m	ED	ZA - GZ Tuchel 5-pol.	High Flex Leder	7S1FH047010306A00
	8 m	ED	ZA - GZ Tuchel 5-pol.	High Flex Leder	7S1FH087010306A00
ABITIG® 17	4 m	ED	ZA - GZ Tuchel 5-pol.	Standard	7S2SK047010306A00
	8 m	ED	ZA - GZ Tuchel 5-pol.	Standard	7S2SK087010306A00
	4 m	ED	ZA - GZ Tuchel 5-pol.	High Flex Leder	7S2SH047010306A00
	8 m	ED	ZA - GZ Tuchel 5-pol.	High Flex Leder	7S2SH087010306A00
ABITIG® 17F	4 m	ED	ZA - GZ Tuchel 5-pol.	Standard	7S2FK047010306A00
	8 m	ED	ZA - GZ Tuchel 5-pol.	Standard	7S2FK087010306A00
	4 m	ED	ZA - GZ Tuchel 5-pol.	High Flex Leder	7S2FH047010306A00
	8 m	ED	ZA - GZ Tuchel 5-pol.	High Flex Leder	7S2FH087010306A00

Technische Änderungen vorbehalten • Verkaufspreise = unverbindliche Preisempfehlung - Angebot freibleibend • © Copyright

ABITIG®-Brennerpreisliste

passend für WIG-Stromquellen des Fabrikates „L-tec“

Brennertyp	Länge	Schalterfunktion	maschinenseitiger Anschluss	Schlauchpaketausführung	Bestellnummer
ABITIG® 26	4 m	ED	ZA - GZ Tuchel 5-pol.	Standard	7S3SK047010306A00
	8 m	ED	ZA - GZ Tuchel 5-pol.	Standard	7S3SK087010306A00
	4 m	ED	ZA - GZ Tuchel 5-pol.	High Flex Leder	7S3SH047010306A00
	8 m	ED	ZA - GZ Tuchel 5-pol.	High Flex Leder	7S3SH087010306A00
ABITIG® 26F	4 m	ED	ZA - GZ Tuchel 5-pol.	Standard	7S3FK047010306A00
	8 m	ED	ZA - GZ Tuchel 5-pol.	Standard	7S3FK087010306A00
	4 m	ED	ZA - GZ Tuchel 5-pol.	High Flex Leder	7S3FH047010306A00
	8 m	ED	ZA - GZ Tuchel 5-pol.	High Flex Leder	7S3FH087010306A00
ABITIG® 24G	4 m	ED	ZA - GZ Tuchel 5-pol.	Standard	7S8SK047010306A00
	8 m	ED	ZA - GZ Tuchel 5-pol.	Standard	7S8SK087010306A00
	4 m	ED	ZA - GZ Tuchel 5-pol.	High Flex Leder	7S8SH047010306A00
	8 m	ED	ZA - GZ Tuchel 5-pol.	High Flex Leder	7S8SH087010306A00
ABITIG® 200	4 m	ED	ZA - GZ Tuchel 5-pol.	Standard	7T4SK047010306A00
	8 m	ED	ZA - GZ Tuchel 5-pol.	Standard	7T4SK087010306A00
	4 m	ED	ZA - GZ Tuchel 5-pol.	High Flex Leder	7T4SH047010306A00
	8 m	ED	ZA - GZ Tuchel 5-pol.	High Flex Leder	7T4SH087010306A00
ABITIG® 200F	4 m	ED	ZA - GZ Tuchel 5-pol.	Standard	7T4FK047010306A00
	8 m	ED	ZA - GZ Tuchel 5-pol.	Standard	7T4FK087010306A00
	4 m	ED	ZA - GZ Tuchel 5-pol.	High Flex Leder	7T4FH047010306A00
	8 m	ED	ZA - GZ Tuchel 5-pol.	High Flex Leder	7T4FH087010306A00
ABITIG® 150	4 m	ED	ZA - GZ Tuchel 5-pol.	Standard	7T6SK047010306A00
	8 m	ED	ZA - GZ Tuchel 5-pol.	Standard	7T6SK087010306A00
	4 m	ED	ZA - GZ Tuchel 5-pol.	High Flex Leder	7T6SH047010306A00
	8 m	ED	ZA - GZ Tuchel 5-pol.	High Flex Leder	7T6SH087010306A00
ABITIG® 150F	4 m	ED	ZA - GZ Tuchel 5-pol.	Standard	7T6FK047010306A00
	8 m	ED	ZA - GZ Tuchel 5-pol.	Standard	7T6FK087010306A00
	4 m	ED	ZA - GZ Tuchel 5-pol.	High Flex Leder	7T6FH047010306A00
	8 m	ED	ZA - GZ Tuchel 5-pol.	High Flex Leder	7T6FH087010306A00

ABITIG®-Brennerpreisliste

passend für WIG-Stromquellen des Fabrikates „L-tec“



Brennertyp	Länge	Schalterfunktion	maschinenseitiger Anschluss	Schlauchpaketausführung	Bestellnummer
ABITIG® 18	4 m	DD	ZA - WZ-0 Tuchel 5-pol.	Standard	7S4SK047020302C12
	8 m	DD	ZA - WZ-0 Tuchel 5-pol.	Standard	7S4SK087020302C12
	4 m	DD	ZA - WZ-0 Tuchel 5-pol.	High Flex Leder	7S4SH047020302C12
	8 m	DD	ZA - WZ-0 Tuchel 5-pol.	High Flex Leder	7S4SH087020302C12
ABITIG® 18F	4 m	DD	ZA - WZ-0 Tuchel 5-pol.	Standard	7S4FK047020302C12
	8 m	DD	ZA - WZ-0 Tuchel 5-pol.	Standard	7S4FK087020302C12
	4 m	DD	ZA - WZ-0 Tuchel 5-pol.	High Flex Leder	7S4FH047020302C12
	8 m	DD	ZA - WZ-0 Tuchel 5-pol.	High Flex Leder	7S4FH087020302C12
ABITIG® 20	4 m	DD	ZA - WZ-0 Tuchel 5-pol.	Standard	7S5SK047020302C12
	8 m	DD	ZA - WZ-0 Tuchel 5-pol.	Standard	7S5SK087020302C12
	4 m	DD	ZA - WZ-0 Tuchel 5-pol.	High Flex Leder	7S5SH047020302C12
	8 m	DD	ZA - WZ-0 Tuchel 5-pol.	High Flex Leder	7S5SH087020302C12
ABITIG® 20F	4 m	DD	ZA - WZ-0 Tuchel 5-pol.	Standard	7S5FK047020302C12
	8 m	DD	ZA - WZ-0 Tuchel 5-pol.	Standard	7S5FK087020302C12
	4 m	DD	ZA - WZ-0 Tuchel 5-pol.	High Flex Leder	7S5FH047020302C12
	8 m	DD	ZA - WZ-0 Tuchel 5-pol.	High Flex Leder	7S5FH087020302C12

Technische Änderungen vorbehalten • Verkaufspreise = unverbindliche Preisempfehlung - Angebot freibleibend • © Copyright

ABITIG®-Brennerpreisliste

passend für WIG-Stromquellen des Fabrikates „L-tec“

Brennertyp	Länge	Schalterfunktion	maschinenseitiger Anschluss	Schlauchpaketausführung	Bestellnummer
ABITIG® 12-1	4 m	DD	ZA - WZ-0 Tuchel 5-pol.	Standard	7S6SK047020302C12
	8 m	DD	ZA - WZ-0 Tuchel 5-pol.	Standard	7S6SK087020302C12
	4 m	DD	ZA - WZ-0 Tuchel 5-pol.	High Flex Leder	7S6SH047020302C12
	8 m	DD	ZA - WZ-0 Tuchel 5-pol.	High Flex Leder	7S6SH087020302C12
ABITIG® 18SC	4 m	DD	ZA - WZ-0 Tuchel 5-pol.	Standard	7S7SK047020302C12
	8 m	DD	ZA - WZ-0 Tuchel 5-pol.	Standard	7S7SK087020302C12
	4 m	DD	ZA - WZ-0 Tuchel 5-pol.	High Flex Leder	7S7SH047020302C12
	8 m	DD	ZA - WZ-0 Tuchel 5-pol.	High Flex Leder	7S7SH087020302C12
ABITIG® 24W	4 m	DD	ZA - WZ-0 Tuchel 5-pol.	Standard	7S9SK047020302C12
	8 m	DD	ZA - WZ-0 Tuchel 5-pol.	Standard	7S9SK087020302C12
	4 m	DD	ZA - WZ-0 Tuchel 5-pol.	High Flex Leder	7S9SH047020302C12
	8 m	DD	ZA - WZ-0 Tuchel 5-pol.	High Flex Leder	7S9SH087020302C12
ABITIG® 450W	4 m	DD	ZA - WZ-0 Tuchel 5-pol.	Standard	7T5SK047020302C12
	8 m	DD	ZA - WZ-0 Tuchel 5-pol.	Standard	7T5SK087020302C12
	4 m	DD	ZA - WZ-0 Tuchel 5-pol.	High Flex Leder	7T5SH047020302C12
	8 m	DD	ZA - WZ-0 Tuchel 5-pol.	High Flex Leder	7T5SH087020302C12
ABITIG® 260W	4 m	DD	ZA - WZ-0 Tuchel 5-pol.	Standard	7T7SK047020302C12
	8 m	DD	ZA - WZ-0 Tuchel 5-pol.	Standard	7T7SK087020302C12
	4 m	DD	ZA - WZ-0 Tuchel 5-pol.	High Flex Leder	7T7SH047020302C12
	8 m	DD	ZA - WZ-0 Tuchel 5-pol.	High Flex Leder	7T7SH087020302C12
ABITIG® 450W SC	4 m	DD	ZA - WZ-0 Tuchel 5-pol.	Standard	
	8 m	DD	ZA - WZ-0 Tuchel 5-pol.	Standard	
	4 m	DD	ZA - WZ-0 Tuchel 5-pol.	High Flex Leder	7T8SH047020302C12
	8 m	DD	ZA - WZ-0 Tuchel 5-pol.	High Flex Leder	7T8SH087020302C12

ABITIG®-Brennerpreisliste

passend für WIG-Stromquellen des Fabrikates „L-tec“



Brennertyp	Länge	Schalterfunktion	maschinenseitiger Anschluss	Schlauchpaketausführung	Bestellnummer
ABITIG® 18	4 m	ED	ZA - WZ-0 Tuchel 5-pol.	Standard	7S4SK047010302A12
	8 m	ED	ZA - WZ-0 Tuchel 5-pol.	Standard	7S4SK087010302A12
	4 m	ED	ZA - WZ-0 Tuchel 5-pol.	High Flex Leder	7S4SH047010302A12
	8 m	ED	ZA - WZ-0 Tuchel 5-pol.	High Flex Leder	7S4SH087010302A12
ABITIG® 18F	4 m	ED	ZA - WZ-0 Tuchel 5-pol.	Standard	7S4FK047010302A12
	8 m	ED	ZA - WZ-0 Tuchel 5-pol.	Standard	7S4FK087010302A12
	4 m	ED	ZA - WZ-0 Tuchel 5-pol.	High Flex Leder	7S4FH047010302A12
	8 m	ED	ZA - WZ-0 Tuchel 5-pol.	High Flex Leder	7S4FH087010302A12
ABITIG® 20	4 m	ED	ZA - WZ-0 Tuchel 5-pol.	Standard	7S5SK047010302A12
	8 m	ED	ZA - WZ-0 Tuchel 5-pol.	Standard	7S5SK087010302A12
	4 m	ED	ZA - WZ-0 Tuchel 5-pol.	High Flex Leder	7S5SH047010302A12
	8 m	ED	ZA - WZ-0 Tuchel 5-pol.	High Flex Leder	7S5SH087010302A12
ABITIG® 20F	4 m	ED	ZA - WZ-0 Tuchel 5-pol.	Standard	7S5FK047010302A12
	8 m	ED	ZA - WZ-0 Tuchel 5-pol.	Standard	7S5FK087010302A12
	4 m	ED	ZA - WZ-0 Tuchel 5-pol.	High Flex Leder	7S5FH047010302A12
	8 m	ED	ZA - WZ-0 Tuchel 5-pol.	High Flex Leder	7S5FH087010302A12

Technische Änderungen vorbehalten • Verkaufspreise = unverbindliche Preisempfehlung - Angebot freibleibend • © Copyright

ABITIG®-Brennerpreisliste

passend für WIG-Stromquellen des Fabrikates „L-tec“

Brennertyp	Länge	Schalterfunktion	maschinenseitiger Anschluss	Schlauchpaketausführung	Bestellnummer
ABITIG® 12-1	4 m	ED	ZA - WZ-0 Tuchel 5-pol.	Standard	7S6SK047020302A12
	8 m	ED	ZA - WZ-0 Tuchel 5-pol.	Standard	7S6SK087020302A12
	4 m	ED	ZA - WZ-0 Tuchel 5-pol.	High Flex Leder	7S6SH047020302A12
	8 m	ED	ZA - WZ-0 Tuchel 5-pol.	High Flex Leder	7S6SH087020302A12
ABITIG® 18SC	4 m	ED	ZA - WZ-0 Tuchel 5-pol.	Standard	7S7SK047020302A12
	8 m	ED	ZA - WZ-0 Tuchel 5-pol.	Standard	7S7SK087020302A12
	4 m	ED	ZA - WZ-0 Tuchel 5-pol.	High Flex Leder	7S7SH047020302A12
	8 m	ED	ZA - WZ-0 Tuchel 5-pol.	High Flex Leder	7S7SH087020302A12
ABITIG® 24W	4 m	ED	ZA - WZ-0 Tuchel 5-pol.	Standard	7S9SK047020302A12
	8 m	ED	ZA - WZ-0 Tuchel 5-pol.	Standard	7S9SK087020302A12
	4 m	ED	ZA - WZ-0 Tuchel 5-pol.	High Flex Leder	7S9SH047020302A12
	8 m	ED	ZA - WZ-0 Tuchel 5-pol.	High Flex Leder	7S9SH087020302A12
ABITIG® 450W	4 m	ED	ZA - WZ-0 Tuchel 5-pol.	Standard	7T5SK047020302A12
	8 m	ED	ZA - WZ-0 Tuchel 5-pol.	Standard	7T5SK087020302A12
	4 m	ED	ZA - WZ-0 Tuchel 5-pol.	High Flex Leder	7T5SH047020302A12
	8 m	ED	ZA - WZ-0 Tuchel 5-pol.	High Flex Leder	7T5SH087020302A12
ABITIG® 260W	4 m	ED	ZA - WZ-0 Tuchel 5-pol.	Standard	7T7SK047020302A12
	8 m	ED	ZA - WZ-0 Tuchel 5-pol.	Standard	7T7SK087020302A12
	4 m	ED	ZA - WZ-0 Tuchel 5-pol.	High Flex Leder	7T7SH047020302A12
	8 m	ED	ZA - WZ-0 Tuchel 5-pol.	High Flex Leder	7T7SH087020302A12
ABITIG® 450W SC	4 m	ED	ZA - WZ-0 Tuchel 5-pol.	Standard	
	8 m	ED	ZA - WZ-0 Tuchel 5-pol.	Standard	
	4 m	ED	ZA - WZ-0 Tuchel 5-pol.	High Flex Leder	7T8SH047020302A12
	8 m	ED	ZA - WZ-0 Tuchel 5-pol.	High Flex Leder	7T8SH087020302A12

ABITIG®-Brennerpreisliste

passend für WIG-Stromquellen des Fabrikates „mahe“



Brennertyp	Länge	Schalterfunktion	maschinenseitiger Anschluss	Schlauchpaketausführung	Bestellnummer
ABITIG® 9	4 m	ED	BSB 35-50 Tuchel 5-pol.	Standard	7S1SK043010060A01
	8 m	ED	BSB 35-50 Tuchel 5-pol.	Standard	7S1SK083010060A01
	4 m	ED	BSB 35-50 Tuchel 5-pol.	High Flex Leder	7S1SH043010060A01
	8 m	ED	BSB 35-50 Tuchel 5-pol.	High Flex Leder	7S1SH083010060A01

ABITIG® 9F	4 m	ED	BSB 35-50 Tuchel 5-pol.	Standard	7S1FK043010060A01
	8 m	ED	BSB 35-50 Tuchel 5-pol.	Standard	7S1FK083010060A01
	4 m	ED	BSB 35-50 Tuchel 5-pol.	High Flex Leder	7S1FH043010060A01
	8 m	ED	BSB 35-50 Tuchel 5-pol.	High Flex Leder	7S1FH083010060A01

ABITIG® 17	4 m	ED	BSB 35-50 Tuchel 5-pol.	Standard	7S2SK043010060A01
	8 m	ED	BSB 35-50 Tuchel 5-pol.	Standard	7S2SK083010060A01
	4 m	ED	BSB 35-50 Tuchel 5-pol.	High Flex Leder	7S2SH043010060A01
	8 m	ED	BSB 35-50 Tuchel 5-pol.	High Flex Leder	7S2SH083010060A01

ABITIG® 17F	4 m	ED	BSB 35-50 Tuchel 5-pol.	Standard	7S2FK043010060A01
	8 m	ED	BSB 35-50 Tuchel 5-pol.	Standard	7S2FK083010060A01
	4 m	ED	BSB 35-50 Tuchel 5-pol.	High Flex Leder	7S2FH043010060A01
	8 m	ED	BSB 35-50 Tuchel 5-pol.	High Flex Leder	7S2FH083010060A01

Technische Änderungen vorbehalten • Verkaufspreise = unverbindliche Preisempfehlung - Angebot freibleibend • © Copyright

ABITIG®-Brennerpreisliste

passend für WIG-Stromquellen des Fabrikates „mahe“

Brennertyp	Länge	Schalterfunktion	maschinenseitiger Anschluss	Schlauchpaketausführung	Bestellnummer
ABITIG® 26	4 m	ED	BSB 35-50 Tuchel 5-pol.	Standard	7S3SK043010060A01
	8 m	ED	BSB 35-50 Tuchel 5-pol.	Standard	7S3SK083010060A01
	4 m	ED	BSB 35-50 Tuchel 5-pol.	High Flex Leder	7S3SH043010060A01
	8 m	ED	BSB 35-50 Tuchel 5-pol.	High Flex Leder	7S3SH083010060A01
ABITIG® 26F	4 m	ED	BSB 35-50 Tuchel 5-pol.	Standard	7S3FK043010060A01
	8 m	ED	BSB 35-50 Tuchel 5-pol.	Standard	7S3FK083010060A01
	4 m	ED	BSB 35-50 Tuchel 5-pol.	High Flex Leder	7S3FH043010060A01
	8 m	ED	BSB 35-50 Tuchel 5-pol.	High Flex Leder	7S3FH083010060A01
ABITIG® 24G	4 m	ED	BSB 35-50 Tuchel 5-pol.	Standard	7S8SK043010060A01
	8 m	ED	BSB 35-50 Tuchel 5-pol.	Standard	7S8SK083010060A01
	4 m	ED	BSB 35-50 Tuchel 5-pol.	High Flex Leder	7S8SH043010060A01
	8 m	ED	BSB 35-50 Tuchel 5-pol.	High Flex Leder	7S8SH083010060A01
ABITIG® 200	4 m	ED	BSB 35-50 Tuchel 5-pol.	Standard	7T4SK043010060A01
	8 m	ED	BSB 35-50 Tuchel 5-pol.	Standard	7T4SK083010060A01
	4 m	ED	BSB 35-50 Tuchel 5-pol.	High Flex Leder	7T4SH043010060A01
	8 m	ED	BSB 35-50 Tuchel 5-pol.	High Flex Leder	7T4SH083010060A01
ABITIG® 200F	4 m	ED	BSB 35-50 Tuchel 5-pol.	Standard	7T4FK043010060A01
	8 m	ED	BSB 35-50 Tuchel 5-pol.	Standard	7T4FK083010060A01
	4 m	ED	BSB 35-50 Tuchel 5-pol.	High Flex Leder	7T4FH043010060A01
	8 m	ED	BSB 35-50 Tuchel 5-pol.	High Flex Leder	7T4FH083010060A01
ABITIG® 150	4 m	ED	BSB 35-50 Tuchel 5-pol.	Standard	7T6SK043010060A01
	8 m	ED	BSB 35-50 Tuchel 5-pol.	Standard	7T6SK083010060A01
	4 m	ED	BSB 35-50 Tuchel 5-pol.	High Flex Leder	7T6SH043010060A01
	8 m	ED	BSB 35-50 Tuchel 5-pol.	High Flex Leder	7T6SH083010060A01
ABITIG® 150F	4 m	ED	BSB 35-50 Tuchel 5-pol.	Standard	7T6FK043010060A01
	8 m	ED	BSB 35-50 Tuchel 5-pol.	Standard	7T6FK083010060A01
	4 m	ED	BSB 35-50 Tuchel 5-pol.	High Flex Leder	7T6FH043010060A01
	8 m	ED	BSB 35-50 Tuchel 5-pol.	High Flex Leder	7T6FH083010060A01

ABITIG®-Brennerpreisliste

passend für WIG-Stromquellen des Fabrikates „mahe“



Brennertyp	Länge	Schalterfunktion	maschinenseitiger Anschluss	Schlauchpaketausführung	Bestellnummer
ABITIG® 9	4 m	DD	BSB 35-50 Tuchel 5-pol.	Standard	7S1SK043020060C01
	8 m	DD	BSB 35-50 Tuchel 5-pol.	Standard	7S1SK083020060C01
	4 m	DD	BSB 35-50 Tuchel 5-pol.	High Flex Leder	7S1SH043020060C01
	8 m	DD	BSB 35-50 Tuchel 5-pol.	High Flex Leder	7S1SH083020060C01
ABITIG® 9F	4 m	DD	BSB 35-50 Tuchel 5-pol.	Standard	7S1FK043020060C01
	8 m	DD	BSB 35-50 Tuchel 5-pol.	Standard	7S1FK083020060C01
	4 m	DD	BSB 35-50 Tuchel 5-pol.	High Flex Leder	7S1FH043020060C01
	8 m	DD	BSB 35-50 Tuchel 5-pol.	High Flex Leder	7S1FH083020060C01
ABITIG® 17	4 m	DD	BSB 35-50 Tuchel 5-pol.	Standard	7S2SK043020060C01
	8 m	DD	BSB 35-50 Tuchel 5-pol.	Standard	7S2SK083020060C01
	4 m	DD	BSB 35-50 Tuchel 5-pol.	High Flex Leder	7S2SH043020060C01
	8 m	DD	BSB 35-50 Tuchel 5-pol.	High Flex Leder	7S2SH083020060C01
ABITIG® 17F	4 m	DD	BSB 35-50 Tuchel 5-pol.	Standard	7S2FK043020060C01
	8 m	DD	BSB 35-50 Tuchel 5-pol.	Standard	7S2FK083020060C01
	4 m	DD	BSB 35-50 Tuchel 5-pol.	High Flex Leder	7S2FH043020060C01
	8 m	DD	BSB 35-50 Tuchel 5-pol.	High Flex Leder	7S2FH083020060C01

Technische Änderungen vorbehalten • Verkaufspreise = unverbindliche Preisempfehlung - Angebot freibleibend • © Copyright

ABITIG®-Brennerpreisliste

passend für WIG-Stromquellen des Fabrikates „mahe“

Brennertyp	Länge	Schalterfunktion	maschinenseitiger Anschluss	Schlauchpaketausführung	Bestellnummer
ABITIG® 26	4 m	DD	BSB 35-50 Tuchel 5-pol.	Standard	7S3SK043020060C01
	8 m	DD	BSB 35-50 Tuchel 5-pol.	Standard	7S3SK083020060C01
	4 m	DD	BSB 35-50 Tuchel 5-pol.	High Flex Leder	7S3SH043020060C01
	8 m	DD	BSB 35-50 Tuchel 5-pol.	High Flex Leder	7S3SH083020060C01
ABITIG® 26F	4 m	DD	BSB 35-50 Tuchel 5-pol.	Standard	7S3FK043020060C01
	8 m	DD	BSB 35-50 Tuchel 5-pol.	Standard	7S3FK083020060C01
	4 m	DD	BSB 35-50 Tuchel 5-pol.	High Flex Leder	7S3FH043020060C01
	8 m	DD	BSB 35-50 Tuchel 5-pol.	High Flex Leder	7S3FH083020060C01
ABITIG® 24G	4 m	DD	BSB 35-50 Tuchel 5-pol.	Standard	7S8SK043020060C01
	8 m	DD	BSB 35-50 Tuchel 5-pol.	Standard	7S8SK083020060C01
	4 m	DD	BSB 35-50 Tuchel 5-pol.	High Flex Leder	7S8SH043020060C01
	8 m	DD	BSB 35-50 Tuchel 5-pol.	High Flex Leder	7S8SH083020060C01
ABITIG® 200	4 m	DD	BSB 35-50 Tuchel 5-pol.	Standard	7T4SK043020060C01
	8 m	DD	BSB 35-50 Tuchel 5-pol.	Standard	7T4SK083020060C01
	4 m	DD	BSB 35-50 Tuchel 5-pol.	High Flex Leder	7T4SH043020060C01
	8 m	DD	BSB 35-50 Tuchel 5-pol.	High Flex Leder	7T4SH083020060C01
ABITIG® 200F	4 m	DD	BSB 35-50 Tuchel 5-pol.	Standard	7T4FK043020060C01
	8 m	DD	BSB 35-50 Tuchel 5-pol.	Standard	7T4FK083020060C01
	4 m	DD	BSB 35-50 Tuchel 5-pol.	High Flex Leder	7T4FH043020060C01
	8 m	DD	BSB 35-50 Tuchel 5-pol.	High Flex Leder	7T4FH083020060C01
ABITIG® 150	4 m	DD	BSB 35-50 Tuchel 5-pol.	Standard	7T6SK043020060C01
	8 m	DD	BSB 35-50 Tuchel 5-pol.	Standard	7T6SK083020060C01
	4 m	DD	BSB 35-50 Tuchel 5-pol.	High Flex Leder	7T6SH043020060C01
	8 m	DD	BSB 35-50 Tuchel 5-pol.	High Flex Leder	7T6SH083020060C01
ABITIG® 150F	4 m	DD	BSB 35-50 Tuchel 5-pol.	Standard	7T6FK043020060C01
	8 m	DD	BSB 35-50 Tuchel 5-pol.	Standard	7T6FK083020060C01
	4 m	DD	BSB 35-50 Tuchel 5-pol.	High Flex Leder	7T6FH043020060C01
	8 m	DD	BSB 35-50 Tuchel 5-pol.	High Flex Leder	7T6FH083020060C01

ABITIG®-Brennerpreisliste

passend für WIG-Stromquellen des Fabrikates „mahe“



Brennertyp	Länge	Schalterfunktion	maschinenseitiger Anschluss	Schlauchpaketausführung	Bestellnummer
ABITIG® 9	4 m	EDP	BSB 35-50 Tuchel 5-pol.	Standard	7S1SK046040060B01
	8 m	EDP	BSB 35-50 Tuchel 5-pol.	Standard	7S1SK086040060B01
	4 m	EDP	BSB 35-50 Tuchel 5-pol.	High Flex Leder	7S1SH046040060B01
	8 m	EDP	BSB 35-50 Tuchel 5-pol.	High Flex Leder	7S1SH086040060B01
ABITIG® 9F	4 m	EDP	BSB 35-50 Tuchel 5-pol.	Standard	7S1FK046040060B01
	8 m	EDP	BSB 35-50 Tuchel 5-pol.	Standard	7S1FK086040060B01
	4 m	EDP	BSB 35-50 Tuchel 5-pol.	High Flex Leder	7S1FH046040060B01
	8 m	EDP	BSB 35-50 Tuchel 5-pol.	High Flex Leder	7S1FH086040060B01
ABITIG® 17	4 m	EDP	BSB 35-50 Tuchel 5-pol.	Standard	7S2SK046040060B01
	8 m	EDP	BSB 35-50 Tuchel 5-pol.	Standard	7S2SK086040060B01
	4 m	EDP	BSB 35-50 Tuchel 5-pol.	High Flex Leder	7S2SH046040060B01
	8 m	EDP	BSB 35-50 Tuchel 5-pol.	High Flex Leder	7S2SH086040060B01
ABITIG® 17F	4 m	EDP	BSB 35-50 Tuchel 5-pol.	Standard	7S2FK046040060B01
	8 m	EDP	BSB 35-50 Tuchel 5-pol.	Standard	7S2FK086040060B01
	4 m	EDP	BSB 35-50 Tuchel 5-pol.	High Flex Leder	7S2FH046040060B01
	8 m	EDP	BSB 35-50 Tuchel 5-pol.	High Flex Leder	7S2FH086040060B01

Technische Änderungen vorbehalten • Verkaufspreise = unverbindliche Preisempfehlung - Angebot freibleibend • © Copyright

ABITIG®-Brennerpreisliste

passend für WIG-Stromquellen des Fabrikates „mahe“

Brennertyp	Länge	Schalterfunktion	maschinenseitiger Anschluss	Schlauchpaketausführung	Bestellnummer
ABITIG® 26	4 m	EDP	BSB 35-50 Tuchel 5-pol.	Standard	7S3SK046040060B01
	8 m	EDP	BSB 35-50 Tuchel 5-pol.	Standard	7S3SK086040060B01
	4 m	EDP	BSB 35-50 Tuchel 5-pol.	High Flex Leder	7S3SH046040060B01
	8 m	EDP	BSB 35-50 Tuchel 5-pol.	High Flex Leder	7S3SH086040060B01
ABITIG® 26F	4 m	EDP	BSB 35-50 Tuchel 5-pol.	Standard	7S3FK046040060B01
	8 m	EDP	BSB 35-50 Tuchel 5-pol.	Standard	7S3FK086040060B01
	4 m	EDP	BSB 35-50 Tuchel 5-pol.	High Flex Leder	7S3FH046040060B01
	8 m	EDP	BSB 35-50 Tuchel 5-pol.	High Flex Leder	7S3FH086040060B01
ABITIG® 24G	4 m	EDP	BSB 35-50 Tuchel 5-pol.	Standard	7S8SK046040060B01
	8 m	EDP	BSB 35-50 Tuchel 5-pol.	Standard	7S8SK086040060B01
	4 m	EDP	BSB 35-50 Tuchel 5-pol.	High Flex Leder	7S8SH046040060B01
	8 m	EDP	BSB 35-50 Tuchel 5-pol.	High Flex Leder	7S8SH086040060B01
ABITIG® 200	4 m	EDP	BSB 35-50 Tuchel 5-pol.	Standard	7T4SK046040060B01
	8 m	EDP	BSB 35-50 Tuchel 5-pol.	Standard	7T4SK086040060B01
	4 m	EDP	BSB 35-50 Tuchel 5-pol.	High Flex Leder	7T4SH046040060B01
	8 m	EDP	BSB 35-50 Tuchel 5-pol.	High Flex Leder	7T4SH086040060B01
ABITIG® 200F	4 m	EDP	BSB 35-50 Tuchel 5-pol.	Standard	7T4FK046040060B01
	8 m	EDP	BSB 35-50 Tuchel 5-pol.	Standard	7T4FK086040060B01
	4 m	EDP	BSB 35-50 Tuchel 5-pol.	High Flex Leder	7T4FH046040060B01
	8 m	EDP	BSB 35-50 Tuchel 5-pol.	High Flex Leder	7T4FH086040060B01
ABITIG® 150	4 m	EDP	BSB 35-50 Tuchel 5-pol.	Standard	7T6SK046040060B01
	8 m	EDP	BSB 35-50 Tuchel 5-pol.	Standard	7T6SK086040060B01
	4 m	EDP	BSB 35-50 Tuchel 5-pol.	High Flex Leder	7T6SH046040060B01
	8 m	EDP	BSB 35-50 Tuchel 5-pol.	High Flex Leder	7T6SH086040060B01
ABITIG® 150F	4 m	EDP	BSB 35-50 Tuchel 5-pol.	Standard	7T6FK046040060B01
	8 m	EDP	BSB 35-50 Tuchel 5-pol.	Standard	7T6FK086040060B01
	4 m	EDP	BSB 35-50 Tuchel 5-pol.	High Flex Leder	7T6FH046040060B01
	8 m	EDP	BSB 35-50 Tuchel 5-pol.	High Flex Leder	7T6FH086040060B01

ABITIG®-Brennerpreisliste

passend für WIG-Stromquellen des Fabrikates „mahe“



Brennertyp	Länge	Schalterfunktion	maschinenseitiger Anschluss	Schlauchpaketausführung	Bestellnummer
ABITIG® 9	4 m	DDP	BSB 35-50 Tuchel 5-pol.	Standard	7S1SK046040060D01
	8 m	DDP	BSB 35-50 Tuchel 5-pol.	Standard	7S1SK086040060D01
	4 m	DDP	BSB 35-50 Tuchel 5-pol.	High Flex Leder	7S1SH046040060D01
	8 m	DDP	BSB 35-50 Tuchel 5-pol.	High Flex Leder	7S1SH086040060D01
ABITIG® 9F	4 m	DDP	BSB 35-50 Tuchel 5-pol.	Standard	7S1FK046040060D01
	8 m	DDP	BSB 35-50 Tuchel 5-pol.	Standard	7S1FK086040060D01
	4 m	DDP	BSB 35-50 Tuchel 5-pol.	High Flex Leder	7S1FH046040060D01
	8 m	DDP	BSB 35-50 Tuchel 5-pol.	High Flex Leder	7S1FH086040060D01
ABITIG® 17	4 m	DDP	BSB 35-50 Tuchel 5-pol.	Standard	7S2SK046040060D01
	8 m	DDP	BSB 35-50 Tuchel 5-pol.	Standard	7S2SK086040060D01
	4 m	DDP	BSB 35-50 Tuchel 5-pol.	High Flex Leder	7S2SH046040060D01
	8 m	DDP	BSB 35-50 Tuchel 5-pol.	High Flex Leder	7S2SH086040060D01
ABITIG® 17F	4 m	DDP	BSB 35-50 Tuchel 5-pol.	Standard	7S2FK046040060D01
	8 m	DDP	BSB 35-50 Tuchel 5-pol.	Standard	7S2FK086040060D01
	4 m	DDP	BSB 35-50 Tuchel 5-pol.	High Flex Leder	7S2FH046040060D01
	8 m	DDP	BSB 35-50 Tuchel 5-pol.	High Flex Leder	7S2FH086040060D01

Technische Änderungen vorbehalten • Verkaufspreise = unverbindliche Preisempfehlung - Angebot freibleibend • © Copyright

ABITIG®-Brennerpreisliste

passend für WIG-Stromquellen des Fabrikates „mahe“

Brennertyp	Länge	Schalterfunktion	maschinenseitiger Anschluss	Schlauchpaketausführung	Bestellnummer
ABITIG® 26	4 m	DDP	BSB 35-50 Tuchel 5-pol.	Standard	7S3SK046040060D01
	8 m	DDP	BSB 35-50 Tuchel 5-pol.	Standard	7S3SK086040060D01
	4 m	DDP	BSB 35-50 Tuchel 5-pol.	High Flex Leder	7S3SH046040060D01
	8 m	DDP	BSB 35-50 Tuchel 5-pol.	High Flex Leder	7S3SH086040060D01
ABITIG® 26F	4 m	DDP	BSB 35-50 Tuchel 5-pol.	Standard	7S3FK046040060D01
	8 m	DDP	BSB 35-50 Tuchel 5-pol.	Standard	7S3FK086040060D01
	4 m	DDP	BSB 35-50 Tuchel 5-pol.	High Flex Leder	7S3FH046040060D01
	8 m	DDP	BSB 35-50 Tuchel 5-pol.	High Flex Leder	7S3FH086040060D01
ABITIG® 24G	4 m	DDP	BSB 35-50 Tuchel 5-pol.	Standard	7S8SK046040060D01
	8 m	DDP	BSB 35-50 Tuchel 5-pol.	Standard	7S8SK086040060D01
	4 m	DDP	BSB 35-50 Tuchel 5-pol.	High Flex Leder	7S8SH046040060D01
	8 m	DDP	BSB 35-50 Tuchel 5-pol.	High Flex Leder	7S8SH086040060D01
ABITIG® 200	4 m	DDP	BSB 35-50 Tuchel 5-pol.	Standard	7T4SK046040060D01
	8 m	DDP	BSB 35-50 Tuchel 5-pol.	Standard	7T4SK086040060D01
	4 m	DDP	BSB 35-50 Tuchel 5-pol.	High Flex Leder	7T4SH046040060D01
	8 m	DDP	BSB 35-50 Tuchel 5-pol.	High Flex Leder	7T4SH086040060D01
ABITIG® 200F	4 m	DDP	BSB 35-50 Tuchel 5-pol.	Standard	7T4FK046040060D01
	8 m	DDP	BSB 35-50 Tuchel 5-pol.	Standard	7T4FK086040060D01
	4 m	DDP	BSB 35-50 Tuchel 5-pol.	High Flex Leder	7T4FH046040060D01
	8 m	DDP	BSB 35-50 Tuchel 5-pol.	High Flex Leder	7T4FH086040060D01
ABITIG® 150	4 m	DDP	BSB 35-50 Tuchel 5-pol.	Standard	7T6SK046040060D01
	8 m	DDP	BSB 35-50 Tuchel 5-pol.	Standard	7T6SK086040060D01
	4 m	DDP	BSB 35-50 Tuchel 5-pol.	High Flex Leder	7T6SH046040060D01
	8 m	DDP	BSB 35-50 Tuchel 5-pol.	High Flex Leder	7T6SH086040060D01
ABITIG® 150F	4 m	DDP	BSB 35-50 Tuchel 5-pol.	Standard	7T6FK046040060D01
	8 m	DDP	BSB 35-50 Tuchel 5-pol.	Standard	7T6FK086040060D01
	4 m	DDP	BSB 35-50 Tuchel 5-pol.	High Flex Leder	7T6FH046040060D01
	8 m	DDP	BSB 35-50 Tuchel 5-pol.	High Flex Leder	7T6FH086040060D01

ABITIG®-Brennerpreisliste

passend für WIG-Stromquellen des Fabrikates „mahe“



Brennertyp	Länge	Schalterfunktion	maschinenseitiger Anschluss	Schlauchpaketausführung	Bestellnummer
ABITIG® 18	4 m	ED	BSB 35-50 Tuchel 5-pol.	Standard	7S4SK043010060A11
	8 m	ED	BSB 35-50 Tuchel 5-pol.	Standard	7S4SK083010060A11
	4 m	ED	BSB 35-50 Tuchel 5-pol.	High Flex Leder	7S4SH043010060A11
	8 m	ED	BSB 35-50 Tuchel 5-pol.	High Flex Leder	7S4SH083010060A11
ABITIG® 18F	4 m	ED	BSB 35-50 Tuchel 5-pol.	Standard	7S4FK043010060A11
	8 m	ED	BSB 35-50 Tuchel 5-pol.	Standard	7S4FK083010060A11
	4 m	ED	BSB 35-50 Tuchel 5-pol.	High Flex Leder	7S4FH043010060A11
	8 m	ED	BSB 35-50 Tuchel 5-pol.	High Flex Leder	7S4FH083010060A11
ABITIG® 20	4 m	ED	BSB 35-50 Tuchel 5-pol.	Standard	7S5SK043010060A11
	8 m	ED	BSB 35-50 Tuchel 5-pol.	Standard	7S5SK083010060A11
	4 m	ED	BSB 35-50 Tuchel 5-pol.	High Flex Leder	7S5SH043010060A11
	8 m	ED	BSB 35-50 Tuchel 5-pol.	High Flex Leder	7S5SH083010060A11
ABITIG® 20F	4 m	ED	BSB 35-50 Tuchel 5-pol.	Standard	7S5FK043010060A11
	8 m	ED	BSB 35-50 Tuchel 5-pol.	Standard	7S5FK083010060A11
	4 m	ED	BSB 35-50 Tuchel 5-pol.	High Flex Leder	7S5FH043010060A11
	8 m	ED	BSB 35-50 Tuchel 5-pol.	High Flex Leder	7S5FH083010060A11

Technische Änderungen vorbehalten • Verkaufspreise = unverbindliche Preisempfehlung - Angebot freibleibend • © Copyright

ABITIG®-Brennerpreisliste

passend für WIG-Stromquellen des Fabrikates „mahe“

Brennertyp	Länge	Schalterfunktion	maschinenseitiger Anschluss	Schlauchpaketausführung	Bestellnummer
ABITIG® 12-1	4 m	ED	BSB 35-50 Tuchel 5-pol.	Standard	7S6SK043010060A11
	8 m	ED	BSB 35-50 Tuchel 5-pol.	Standard	7S6SK083010060A11
	4 m	ED	BSB 35-50 Tuchel 5-pol.	High Flex Leder	7S6SH043010060A11
	8 m	ED	BSB 35-50 Tuchel 5-pol.	High Flex Leder	7S6SH083010060A11

ABITIG® 18SC	4 m	ED	BSB 35-50 Tuchel 5-pol.	Standard	7S7SK043010060A11
	8 m	ED	BSB 35-50 Tuchel 5-pol.	Standard	7S7SK083010060A11
	4 m	ED	BSB 35-50 Tuchel 5-pol.	High Flex Leder	7S7SH043010060A11
	8 m	ED	BSB 35-50 Tuchel 5-pol.	High Flex Leder	7S7SH083010060A11

ABITIG® 24W	4 m	ED	BSB 35-50 Tuchel 5-pol.	Standard	7S9SK043010060A11
	8 m	ED	BSB 35-50 Tuchel 5-pol.	Standard	7S9SK083010060A11
	4 m	ED	BSB 35-50 Tuchel 5-pol.	High Flex Leder	7S9SH043010060A11
	8 m	ED	BSB 35-50 Tuchel 5-pol.	High Flex Leder	7S9SH083010060A11

ABITIG® 450W	4 m	ED	BSB 35-50 Tuchel 5-pol.	Standard	7T5SK043010160A11
	8 m	ED	BSB 35-50 Tuchel 5-pol.	Standard	7T5SK083010160A11
	4 m	ED	BSB 35-50 Tuchel 5-pol.	High Flex Leder	7T5SH043010160A11
	8 m	ED	BSB 35-50 Tuchel 5-pol.	High Flex Leder	7T5SH083010160A11

ABITIG® 260W	4 m	ED	BSB 35-50 Tuchel 5-pol.	Standard	7T7SK043010160A11
	8 m	ED	BSB 35-50 Tuchel 5-pol.	Standard	7T7SK083010160A11
	4 m	ED	BSB 35-50 Tuchel 5-pol.	High Flex Leder	7T7SH043010160A11
	8 m	ED	BSB 35-50 Tuchel 5-pol.	High Flex Leder	7T7SH083010160A11

ABITIG® 450W SC	4 m	ED	BSB 35-50 Tuchel 5-pol.	Standard	
	8 m	ED	BSB 35-50 Tuchel 5-pol.	Standard	
	4 m	ED	BSB 35-50 Tuchel 5-pol.	High Flex Leder	7T8SH043010160A11
	8 m	ED	BSB 35-50 Tuchel 5-pol.	High Flex Leder	7T8SH083010160A11

ABITIG®-Brennerpreisliste

passend für WIG-Stromquellen des Fabrikates „mahe“



Brennertyp	Länge	Schalterfunktion	maschinenseitiger Anschluss	Schlauchpaketausführung	Bestellnummer
ABITIG® 18	4 m	DD	BSB 35-50 Tuchel 5-pol.	Standard	7S4SK043020060C11
	8 m	DD	BSB 35-50 Tuchel 5-pol.	Standard	7S4SK083020060C11
	4 m	DD	BSB 35-50 Tuchel 5-pol.	High Flex Leder	7S4SH043020060C11
	8 m	DD	BSB 35-50 Tuchel 5-pol.	High Flex Leder	7S4SH083020060C11
ABITIG® 18F	4 m	DD	BSB 35-50 Tuchel 5-pol.	Standard	7S4FK043020060C11
	8 m	DD	BSB 35-50 Tuchel 5-pol.	Standard	7S4FK083020060C11
	4 m	DD	BSB 35-50 Tuchel 5-pol.	High Flex Leder	7S4FH043020060C11
	8 m	DD	BSB 35-50 Tuchel 5-pol.	High Flex Leder	7S4FH083020060C11
ABITIG® 20	4 m	DD	BSB 35-50 Tuchel 5-pol.	Standard	7S5SK043020060C11
	8 m	DD	BSB 35-50 Tuchel 5-pol.	Standard	7S5SK083020060C11
	4 m	DD	BSB 35-50 Tuchel 5-pol.	High Flex Leder	7S5SH043020060C11
	8 m	DD	BSB 35-50 Tuchel 5-pol.	High Flex Leder	7S5SH083020060C11
ABITIG® 20F	4 m	DD	BSB 35-50 Tuchel 5-pol.	Standard	7S5FK043020060C11
	8 m	DD	BSB 35-50 Tuchel 5-pol.	Standard	7S5FK083020060C11
	4 m	DD	BSB 35-50 Tuchel 5-pol.	High Flex Leder	7S5FH043020060C11
	8 m	DD	BSB 35-50 Tuchel 5-pol.	High Flex Leder	7S5FH083020060C11

Technische Änderungen vorbehalten • Verkaufspreise = unverbindliche Preisempfehlung - Angebot freibleibend • © Copyright

ABITIG®-Brennerpreisliste

passend für WIG-Stromquellen des Fabrikates „mahe“

Brennertyp	Länge	Schalterfunktion	maschinenseitiger Anschluss	Schlauchpaketausführung	Bestellnummer
ABITIG® 12-1	4 m	DD	BSB 35-50 Tuchel 5-pol.	Standard	7S6SK043020060C11
	8 m	DD	BSB 35-50 Tuchel 5-pol.	Standard	7S6SK083020060C11
	4 m	DD	BSB 35-50 Tuchel 5-pol.	High Flex Leder	7S6SH043020060C11
	8 m	DD	BSB 35-50 Tuchel 5-pol.	High Flex Leder	7S6SH083020060C11
ABITIG® 18SC	4 m	DD	BSB 35-50 Tuchel 5-pol.	Standard	7S7SK043020060C11
	8 m	DD	BSB 35-50 Tuchel 5-pol.	Standard	7S7SK083020060C11
	4 m	DD	BSB 35-50 Tuchel 5-pol.	High Flex Leder	7S7SH043020060C11
	8 m	DD	BSB 35-50 Tuchel 5-pol.	High Flex Leder	7S7SH083020060C11
ABITIG® 24W	4 m	DD	BSB 35-50 Tuchel 5-pol.	Standard	7S9SK043020060C11
	8 m	DD	BSB 35-50 Tuchel 5-pol.	Standard	7S9SK083020060C11
	4 m	DD	BSB 35-50 Tuchel 5-pol.	High Flex Leder	7S9SH043020060C11
	8 m	DD	BSB 35-50 Tuchel 5-pol.	High Flex Leder	7S9SH083020060C11
ABITIG® 450W	4 m	DD	BSB 35-50 Tuchel 5-pol.	Standard	7T5SK043020160C11
	8 m	DD	BSB 35-50 Tuchel 5-pol.	Standard	7T5SK083020160C11
	4 m	DD	BSB 35-50 Tuchel 5-pol.	High Flex Leder	7T5SH043020160C11
	8 m	DD	BSB 35-50 Tuchel 5-pol.	High Flex Leder	7T5SH083020160C11
ABITIG® 260W	4 m	DD	BSB 35-50 Tuchel 5-pol.	Standard	7T7SK043020160C11
	8 m	DD	BSB 35-50 Tuchel 5-pol.	Standard	7T7SK083020160C11
	4 m	DD	BSB 35-50 Tuchel 5-pol.	High Flex Leder	7T7SH043020160C11
	8 m	DD	BSB 35-50 Tuchel 5-pol.	High Flex Leder	7T7SH083020160C11
ABITIG® 450W SC	4 m	DD	BSB 35-50 Tuchel 5-pol.	Standard	
	8 m	DD	BSB 35-50 Tuchel 5-pol.	Standard	
	4 m	DD	BSB 35-50 Tuchel 5-pol.	High Flex Leder	7T8SH043020160C11
	8 m	DD	BSB 35-50 Tuchel 5-pol.	High Flex Leder	7T8SH083020160C11

ABITIG®-Brennerpreisliste

passend für WIG-Stromquellen des Fabrikates „mahe“



Brennertyp	Länge	Schalterfunktion	maschinenseitiger Anschluss	Schlauchpaketausführung	Bestellnummer
ABITIG® 18	4 m	EDP	BSB 35-50 Tuchel 5-pol.	Standard	7S4SK046040060B11
	8 m	EDP	BSB 35-50 Tuchel 5-pol.	Standard	7S4SK086040060B11
	4 m	EDP	BSB 35-50 Tuchel 5-pol.	High Flex Leder	7S4SH046040060B11
	8 m	EDP	BSB 35-50 Tuchel 5-pol.	High Flex Leder	7S4SH086040060B11
ABITIG® 18F	4 m	EDP	BSB 35-50 Tuchel 5-pol.	Standard	7S4FK046040060B11
	8 m	EDP	BSB 35-50 Tuchel 5-pol.	Standard	7S4FK086040060B11
	4 m	EDP	BSB 35-50 Tuchel 5-pol.	High Flex Leder	7S4FH046040060B11
	8 m	EDP	BSB 35-50 Tuchel 5-pol.	High Flex Leder	7S4FH086040060B11
ABITIG® 20	4 m	EDP	BSB 35-50 Tuchel 5-pol.	Standard	7S5SK046040060B11
	8 m	EDP	BSB 35-50 Tuchel 5-pol.	Standard	7S5SK086040060B11
	4 m	EDP	BSB 35-50 Tuchel 5-pol.	High Flex Leder	7S5SH046040060B11
	8 m	EDP	BSB 35-50 Tuchel 5-pol.	High Flex Leder	7S5SH086040060B11
ABITIG® 20F	4 m	EDP	BSB 35-50 Tuchel 5-pol.	Standard	7S5FK046040060B11
	8 m	EDP	BSB 35-50 Tuchel 5-pol.	Standard	7S5FK086040060B11
	4 m	EDP	BSB 35-50 Tuchel 5-pol.	High Flex Leder	7S5FH046040060B11
	8 m	EDP	BSB 35-50 Tuchel 5-pol.	High Flex Leder	7S5FH086040060B11

Technische Änderungen vorbehalten • Verkaufspreise = unverbindliche Preisempfehlung - Angebot freibleibend • © Copyright

ABITIG®-Brennerpreisliste

passend für WIG-Stromquellen des Fabrikates „mahe“

Brennertyp	Länge	Schalterfunktion	maschinenseitiger Anschluss	Schlauchpaketausführung	Bestellnummer
ABITIG® 12-1	4 m	EDP	BSB 35-50 Tuchel 5-pol.	Standard	7S6SK046040060B11
	8 m	EDP	BSB 35-50 Tuchel 5-pol.	Standard	7S6SK086040060B11
	4 m	EDP	BSB 35-50 Tuchel 5-pol.	High Flex Leder	7S6SH046040060B11
	8 m	EDP	BSB 35-50 Tuchel 5-pol.	High Flex Leder	7S6SH086040060B11

ABITIG® 18SC	4 m	EDP	BSB 35-50 Tuchel 5-pol.	Standard	7S7SK046040060B11
	8 m	EDP	BSB 35-50 Tuchel 5-pol.	Standard	7S7SK086040060B11
	4 m	EDP	BSB 35-50 Tuchel 5-pol.	High Flex Leder	7S7SH046040060B11
	8 m	EDP	BSB 35-50 Tuchel 5-pol.	High Flex Leder	7S7SH086040060B11

ABITIG® 24W	4 m	EDP	BSB 35-50 Tuchel 5-pol.	Standard	7S9SK046040060B11
	8 m	EDP	BSB 35-50 Tuchel 5-pol.	Standard	7S9SK086040060B11
	4 m	EDP	BSB 35-50 Tuchel 5-pol.	High Flex Leder	7S9SH046040060B11
	8 m	EDP	BSB 35-50 Tuchel 5-pol.	High Flex Leder	7S9SH086040060B11

ABITIG® 450W	4 m	EDP	BSB 35-50 Tuchel 5-pol.	Standard	7T5SK046040160B11
	8 m	EDP	BSB 35-50 Tuchel 5-pol.	Standard	7T5SK086040160B11
	4 m	EDP	BSB 35-50 Tuchel 5-pol.	High Flex Leder	7T5SH046040160B11
	8 m	EDP	BSB 35-50 Tuchel 5-pol.	High Flex Leder	7T5SH086040160B11

ABITIG® 260W	4 m	EDP	BSB 35-50 Tuchel 5-pol.	Standard	7T7SK046040160B11
	8 m	EDP	BSB 35-50 Tuchel 5-pol.	Standard	7T7SK086040160B11
	4 m	EDP	BSB 35-50 Tuchel 5-pol.	High Flex Leder	7T7SH046040160B11
	8 m	EDP	BSB 35-50 Tuchel 5-pol.	High Flex Leder	7T7SH086040160B11

ABITIG® 450W SC	4 m	EDP	BSB 35-50 Tuchel 5-pol.	Standard	
	8 m	EDP	BSB 35-50 Tuchel 5-pol.	Standard	
	4 m	EDP	BSB 35-50 Tuchel 5-pol.	High Flex Leder	7T8SH046040160B11
	8 m	EDP	BSB 35-50 Tuchel 5-pol.	High Flex Leder	7T8SH086040160B11

ABITIG®-Brennerpreisliste

passend für WIG-Stromquellen des Fabrikates „mahe“



Brennertyp	Länge	Schalterfunktion	maschinenseitiger Anschluss	Schlauchpaketausführung	Bestellnummer
ABITIG® 18	4 m	DDP	BSB 35-50 Tuchel 5-pol.	Standard	7S4SK046040060D11
	8 m	DDP	BSB 35-50 Tuchel 5-pol.	Standard	7S4SK086040060D11
	4 m	DDP	BSB 35-50 Tuchel 5-pol.	High Flex Leder	7S4SH046040060D11
	8 m	DDP	BSB 35-50 Tuchel 5-pol.	High Flex Leder	7S4SH086040060D11
ABITIG® 18F	4 m	DDP	BSB 35-50 Tuchel 5-pol.	Standard	7S4FK046040060D11
	8 m	DDP	BSB 35-50 Tuchel 5-pol.	Standard	7S4FK086040060D11
	4 m	DDP	BSB 35-50 Tuchel 5-pol.	High Flex Leder	7S4FH046040060D11
	8 m	DDP	BSB 35-50 Tuchel 5-pol.	High Flex Leder	7S4FH086040060D11
ABITIG® 20	4 m	DDP	BSB 35-50 Tuchel 5-pol.	Standard	7S5SK046040060D11
	8 m	DDP	BSB 35-50 Tuchel 5-pol.	Standard	7S5SK086040060D11
	4 m	DDP	BSB 35-50 Tuchel 5-pol.	High Flex Leder	7S5SH046040060D11
	8 m	DDP	BSB 35-50 Tuchel 5-pol.	High Flex Leder	7S5SH086040060D11
ABITIG® 20F	4 m	DDP	BSB 35-50 Tuchel 5-pol.	Standard	7S5FK046040060D11
	8 m	DDP	BSB 35-50 Tuchel 5-pol.	Standard	7S5FK086040060D11
	4 m	DDP	BSB 35-50 Tuchel 5-pol.	High Flex Leder	7S5FH046040060D11
	8 m	DDP	BSB 35-50 Tuchel 5-pol.	High Flex Leder	7S5FH086040060D11

Technische Änderungen vorbehalten • Verkaufspreise = unverbindliche Preisempfehlung - Angebot freibleibend • © Copyright

ABITIG®-Brennerpreisliste

passend für WIG-Stromquellen des Fabrikates „mahe“

Brennertyp	Länge	Schalterfunktion	maschinenseitiger Anschluss	Schlauchpaketausführung	Bestellnummer
ABITIG® 12-1	4 m	DDP	BSB 35-50 Tuchel 5-pol.	Standard	7S6SK046040060 D11
	8 m	DDP	BSB 35-50 Tuchel 5-pol.	Standard	7S6SK086040060 D11
	4 m	DDP	BSB 35-50 Tuchel 5-pol.	High Flex Leder	7S6SH046040060 D11
	8 m	DDP	BSB 35-50 Tuchel 5-pol.	High Flex Leder	7S6SH086040060 D11
ABITIG® 18SC	4 m	DDP	BSB 35-50 Tuchel 5-pol.	Standard	7S7SK046040060 D11
	8 m	DDP	BSB 35-50 Tuchel 5-pol.	Standard	7S7SK086040060 D11
	4 m	DDP	BSB 35-50 Tuchel 5-pol.	High Flex Leder	7S7SH046040060 D11
	8 m	DDP	BSB 35-50 Tuchel 5-pol.	High Flex Leder	7S7SH086040060 D11
ABITIG® 24W	4 m	DDP	BSB 35-50 Tuchel 5-pol.	Standard	7S9SK046040060 D11
	8 m	DDP	BSB 35-50 Tuchel 5-pol.	Standard	7S9SK086040060 D11
	4 m	DDP	BSB 35-50 Tuchel 5-pol.	High Flex Leder	7S9SH046040060 D11
	8 m	DDP	BSB 35-50 Tuchel 5-pol.	High Flex Leder	7S9SH086040060 D11
ABITIG® 450W	4 m	DDP	BSB 35-50 Tuchel 5-pol.	Standard	7T5SK046040160 D11
	8 m	DDP	BSB 35-50 Tuchel 5-pol.	Standard	7T5SK086040160 D11
	4 m	DDP	BSB 35-50 Tuchel 5-pol.	High Flex Leder	7T5SH046040160 D11
	8 m	DDP	BSB 35-50 Tuchel 5-pol.	High Flex Leder	7T5SH086040160 D11
ABITIG® 260W	4 m	DDP	BSB 35-50 Tuchel 5-pol.	Standard	7T7SK046040160 D11
	8 m	DDP	BSB 35-50 Tuchel 5-pol.	Standard	7T7SK086040160 D11
	4 m	DDP	BSB 35-50 Tuchel 5-pol.	High Flex Leder	7T7SH046040160 D11
	8 m	DDP	BSB 35-50 Tuchel 5-pol.	High Flex Leder	7T7SH086040160 D11
ABITIG® 450W SC	4 m	DDP	BSB 35-50 Tuchel 5-pol.	Standard	
	8 m	DDP	BSB 35-50 Tuchel 5-pol.	Standard	
	4 m	DDP	BSB 35-50 Tuchel 5-pol.	High Flex Leder	7T8SH046040160 D11
	8 m	DDP	BSB 35-50 Tuchel 5-pol.	High Flex Leder	7T8SH086040160 D11

ABITIG®-Brennerpreisliste

passend für WIG-Stromquellen des Fabrikates „merkle“



Brennertyp	Länge	Schalterfunktion	maschinenseitiger Anschluss	Schlauchpaketausführung	Bestellnummer
ABITIG® 9	4 m	ED/DD	ZA - GZ Tuchel 3-pol.	Standard	7S1SK047020313A00
	8 m	ED/DD	ZA - GZ Tuchel 3-pol.	Standard	7S1SK087020313A00
	4 m	ED/DD	ZA - GZ Tuchel 3-pol.	High Flex Leder	7S1SH047020313A00
	8 m	ED/DD	ZA - GZ Tuchel 3-pol.	High Flex Leder	7S1SH087020313A00

ABITIG® 9F	4 m	ED/DD	ZA - GZ Tuchel 3-pol.	Standard	7S1FK047020313A00
	8 m	ED/DD	ZA - GZ Tuchel 3-pol.	Standard	7S1FK087020313A00
	4 m	ED/DD	ZA - GZ Tuchel 3-pol.	High Flex Leder	7S1FH047020313A00
	8 m	ED/DD	ZA - GZ Tuchel 3-pol.	High Flex Leder	7S1FH087020313A00

ABITIG® 17	4 m	ED/DD	ZA - GZ Tuchel 3-pol.	Standard	7S2SK047020313A00
	8 m	ED/DD	ZA - GZ Tuchel 3-pol.	Standard	7S2SK087020313A00
	4 m	ED/DD	ZA - GZ Tuchel 3-pol.	High Flex Leder	7S2SH047020313A00
	8 m	ED/DD	ZA - GZ Tuchel 3-pol.	High Flex Leder	7S2SH087020313A00

ABITIG® 17F	4 m	ED/DD	ZA - GZ Tuchel 3-pol.	Standard	7S2FK047020313A00
	8 m	ED/DD	ZA - GZ Tuchel 3-pol.	Standard	7S2FK087020313A00
	4 m	ED/DD	ZA - GZ Tuchel 3-pol.	High Flex Leder	7S2FH047020313A00
	8 m	ED/DD	ZA - GZ Tuchel 3-pol.	High Flex Leder	7S2FH087020313A00

Technische Änderungen vorbehalten • Verkaufspreise = unverbindliche Preisempfehlung - Angebot freibleibend • © Copyright

ABITIG®-Brennerpreisliste

passend für WIG-Stromquellen des Fabrikates „merkle“

Brennertyp	Länge	Schalterfunktion	maschinenseitiger Anschluss	Schlauchpaketausführung	Bestellnummer
ABITIG® 26	4 m	ED/DD	ZA - GZ Tuchel 3-pol.	Standard	7S3SK047020313A00
	8 m	ED/DD	ZA - GZ Tuchel 3-pol.	Standard	7S3SK087020313A00
	4 m	ED/DD	ZA - GZ Tuchel 3-pol.	High Flex Leder	7S3SH047020313A00
	8 m	ED/DD	ZA - GZ Tuchel 3-pol.	High Flex Leder	7S3SH087020313A00

ABITIG® 26F	4 m	ED/DD	ZA - GZ Tuchel 3-pol.	Standard	7S3FK047020313A00
	8 m	ED/DD	ZA - GZ Tuchel 3-pol.	Standard	7S3FK087020313A00
	4 m	ED/DD	ZA - GZ Tuchel 3-pol.	High Flex Leder	7S3FH047020313A00
	8 m	ED/DD	ZA - GZ Tuchel 3-pol.	High Flex Leder	7S3FH087020313A00

ABITIG® 24G	4 m	ED/DD	ZA - GZ Tuchel 3-pol.	Standard	7S8SK047020313A00
	8 m	ED/DD	ZA - GZ Tuchel 3-pol.	Standard	7S8SK087020313A00
	4 m	ED/DD	ZA - GZ Tuchel 3-pol.	High Flex Leder	7S8SH047020313A00
	8 m	ED/DD	ZA - GZ Tuchel 3-pol.	High Flex Leder	7S8SH087020313A00

ABITIG® 200	4 m	ED/DD	ZA - GZ Tuchel 3-pol.	Standard	7T4SK047020313A00
	8 m	ED/DD	ZA - GZ Tuchel 3-pol.	Standard	7T4SK087020313A00
	4 m	ED/DD	ZA - GZ Tuchel 3-pol.	High Flex Leder	7T4SH047020313A00
	8 m	ED/DD	ZA - GZ Tuchel 3-pol.	High Flex Leder	7T4SH087020313A00

ABITIG® 200F	4 m	ED/DD	ZA - GZ Tuchel 3-pol.	Standard	7T4FK047020313A00
	8 m	ED/DD	ZA - GZ Tuchel 3-pol.	Standard	7T4FK087020313A00
	4 m	ED/DD	ZA - GZ Tuchel 3-pol.	High Flex Leder	7T4FH047020313A00
	8 m	ED/DD	ZA - GZ Tuchel 3-pol.	High Flex Leder	7T4FH087020313A00

ABITIG® 150	4 m	ED/DD	ZA - GZ Tuchel 3-pol.	Standard	7T6SK047020313A00
	8 m	ED/DD	ZA - GZ Tuchel 3-pol.	Standard	7T6SK087020313A00
	4 m	ED/DD	ZA - GZ Tuchel 3-pol.	High Flex Leder	7T6SH047020313A00
	8 m	ED/DD	ZA - GZ Tuchel 3-pol.	High Flex Leder	7T6SH087020313A00

ABITIG® 150F	4 m	ED/DD	ZA - GZ Tuchel 3-pol.	Standard	7T6FK047020313A00
	8 m	ED/DD	ZA - GZ Tuchel 3-pol.	Standard	7T6FK087020313A00
	4 m	ED/DD	ZA - GZ Tuchel 3-pol.	High Flex Leder	7T6FH047020313A00
	8 m	ED/DD	ZA - GZ Tuchel 3-pol.	High Flex Leder	7T6FH087020313A00

ABITIG®-Brennerpreisliste

passend für WIG-Stromquellen des Fabrikates „merkle“



Brennertyp	Länge	Schalterfunktion	maschinenseitiger Anschluss	Schlauchpaketausführung	Bestellnummer
ABITIG® 9	4 m	DD	ZA - GZ Tuchel 5-pol.	Standard	7S1SK043020301A00
	8 m	DD	ZA - GZ Tuchel 5-pol.	Standard	7S1SK083020301A00
	4 m	DD	ZA - GZ Tuchel 5-pol.	High Flex Leder	7S1SH043020301A00
	8 m	DD	ZA - GZ Tuchel 5-pol.	High Flex Leder	7S1SH083020301A00

ABITIG® 9F	4 m	DD	ZA - GZ Tuchel 5-pol.	Standard	7S1FK043020301A00
	8 m	DD	ZA - GZ Tuchel 5-pol.	Standard	7S1FK083020301A00
	4 m	DD	ZA - GZ Tuchel 5-pol.	High Flex Leder	7S1FH043020301A00
	8 m	DD	ZA - GZ Tuchel 5-pol.	High Flex Leder	7S1FH083020301A00

ABITIG® 17	4 m	DD	ZA - GZ Tuchel 5-pol.	Standard	7S2SK043020301A00
	8 m	DD	ZA - GZ Tuchel 5-pol.	Standard	7S2SK083020301A00
	4 m	DD	ZA - GZ Tuchel 5-pol.	High Flex Leder	7S2SH043020301A00
	8 m	DD	ZA - GZ Tuchel 5-pol.	High Flex Leder	7S2SH083020301A00

ABITIG® 17F	4 m	DD	ZA - GZ Tuchel 5-pol.	Standard	7S2FK043020301A00
	8 m	DD	ZA - GZ Tuchel 5-pol.	Standard	7S2FK083020301A00
	4 m	DD	ZA - GZ Tuchel 5-pol.	High Flex Leder	7S2FH043020301A00
	8 m	DD	ZA - GZ Tuchel 5-pol.	High Flex Leder	7S2FH083020301A00

Technische Änderungen vorbehalten • Verkaufspreise = unverbindliche Preisempfehlung - Angebot freibleibend • © Copyright

ABITIG®-Brennerpreisliste

passend für WIG-Stromquellen des Fabrikates „merkle“

Brennertyp	Länge	Schalterfunktion	maschinenseitiger Anschluss	Schlauchpaketausführung	Bestellnummer
ABITIG® 26	4 m	DD	ZA - GZ Tuchel 5-pol.	Standard	7S3SK043020301A00
	8 m	DD	ZA - GZ Tuchel 5-pol.	Standard	7S3SK083020301A00
	4 m	DD	ZA - GZ Tuchel 5-pol.	High Flex Leder	7S3SH043020301A00
	8 m	DD	ZA - GZ Tuchel 5-pol.	High Flex Leder	7S3SH083020301A00
ABITIG® 26F	4 m	DD	ZA - GZ Tuchel 5-pol.	Standard	7S3FK043020301A00
	8 m	DD	ZA - GZ Tuchel 5-pol.	Standard	7S3FK083020301A00
	4 m	DD	ZA - GZ Tuchel 5-pol.	High Flex Leder	7S3FH043020301A00
	8 m	DD	ZA - GZ Tuchel 5-pol.	High Flex Leder	7S3FH083020301A00
ABITIG® 24G	4 m	DD	ZA - GZ Tuchel 5-pol.	Standard	7S8SK043020301A00
	8 m	DD	ZA - GZ Tuchel 5-pol.	Standard	7S8SK083020301A00
	4 m	DD	ZA - GZ Tuchel 5-pol.	High Flex Leder	7S8SH043020301A00
	8 m	DD	ZA - GZ Tuchel 5-pol.	High Flex Leder	7S8SH083020301A00
ABITIG® 200	4 m	DD	ZA - GZ Tuchel 5-pol.	Standard	7T4SK043020301A00
	8 m	DD	ZA - GZ Tuchel 5-pol.	Standard	7T4SK083020301A00
	4 m	DD	ZA - GZ Tuchel 5-pol.	High Flex Leder	7T4SH043020301A00
	8 m	DD	ZA - GZ Tuchel 5-pol.	High Flex Leder	7T4SH083020301A00
ABITIG® 200F	4 m	DD	ZA - GZ Tuchel 5-pol.	Standard	7T4FK043020301A00
	8 m	DD	ZA - GZ Tuchel 5-pol.	Standard	7T4FK083020301A00
	4 m	DD	ZA - GZ Tuchel 5-pol.	High Flex Leder	7T4FH043020301A00
	8 m	DD	ZA - GZ Tuchel 5-pol.	High Flex Leder	7T4FH083020301A00
ABITIG® 150	4 m	DD	ZA - GZ Tuchel 5-pol.	Standard	7T6SK043020301A00
	8 m	DD	ZA - GZ Tuchel 5-pol.	Standard	7T6SK083020301A00
	4 m	DD	ZA - GZ Tuchel 5-pol.	High Flex Leder	7T6SH043020301A00
	8 m	DD	ZA - GZ Tuchel 5-pol.	High Flex Leder	7T6SH083020301A00
ABITIG® 150F	4 m	DD	ZA - GZ Tuchel 5-pol.	Standard	7T6FK043020301A00
	8 m	DD	ZA - GZ Tuchel 5-pol.	Standard	7T6FK083020301A00
	4 m	DD	ZA - GZ Tuchel 5-pol.	High Flex Leder	7T6FH043020301A00
	8 m	DD	ZA - GZ Tuchel 5-pol.	High Flex Leder	7T6FH083020301A00

ABITIG®-Brennerpreisliste

passend für WIG-Stromquellen des Fabrikates „merkle“



Brennertyp	Länge	Schalterfunktion	maschinenseitiger Anschluss	Schlauchpaketausführung	Bestellnummer
ABITIG® 9	4 m	EDP	ZA - GZ Tuchel 5-pol.	Standard	7S1SK046040330A00
	8 m	EDP	ZA - GZ Tuchel 5-pol.	Standard	7S1SK086040330A00
	4 m	EDP	ZA - GZ Tuchel 5-pol.	High Flex Leder	7S1SH046040330A00
	8 m	EDP	ZA - GZ Tuchel 5-pol.	High Flex Leder	7S1SH086040330A00

ABITIG® 9F	4 m	EDP	ZA - GZ Tuchel 5-pol.	Standard	7S1FK046040330A00
	8 m	EDP	ZA - GZ Tuchel 5-pol.	Standard	7S1FK086040330A00
	4 m	EDP	ZA - GZ Tuchel 5-pol.	High Flex Leder	7S1FH046040330A00
	8 m	EDP	ZA - GZ Tuchel 5-pol.	High Flex Leder	7S1FH086040330A00

ABITIG® 17	4 m	EDP	ZA - GZ Tuchel 5-pol.	Standard	7S2SK046040330A00
	8 m	EDP	ZA - GZ Tuchel 5-pol.	Standard	7S2SK086040330A00
	4 m	EDP	ZA - GZ Tuchel 5-pol.	High Flex Leder	7S2SH046040330A00
	8 m	EDP	ZA - GZ Tuchel 5-pol.	High Flex Leder	7S2SH086040330A00

ABITIG® 17F	4 m	EDP	ZA - GZ Tuchel 5-pol.	Standard	7S2FK046040330A00
	8 m	EDP	ZA - GZ Tuchel 5-pol.	Standard	7S2FK086040330A00
	4 m	EDP	ZA - GZ Tuchel 5-pol.	High Flex Leder	7S2FH046040330A00
	8 m	EDP	ZA - GZ Tuchel 5-pol.	High Flex Leder	7S2FH086040330A00

Technische Änderungen vorbehalten • Verkaufspreise = unverbindliche Preisempfehlung - Angebot freibleibend • © Copyright

ABITIG®-Brennerpreisliste

passend für WIG-Stromquellen des Fabrikates „merkle“

Brennertyp	Länge	Schalterfunktion	maschinenseitiger Anschluss	Schlauchpaketausführung	Bestellnummer
ABITIG® 26	4 m	EDP	ZA - GZ Tuchel 5-pol.	Standard	7S3SK046040330A00
	8 m	EDP	ZA - GZ Tuchel 5-pol.	Standard	7S3SK086040330A00
	4 m	EDP	ZA - GZ Tuchel 5-pol.	High Flex Leder	7S3SH046040330A00
	8 m	EDP	ZA - GZ Tuchel 5-pol.	High Flex Leder	7S3SH086040330A00
ABITIG® 26F	4 m	EDP	ZA - GZ Tuchel 5-pol.	Standard	7S3FK046040330A00
	8 m	EDP	ZA - GZ Tuchel 5-pol.	Standard	7S3FK086040330A00
	4 m	EDP	ZA - GZ Tuchel 5-pol.	High Flex Leder	7S3FH046040330A00
	8 m	EDP	ZA - GZ Tuchel 5-pol.	High Flex Leder	7S3FH086040330A00
ABITIG® 24G	4 m	EDP	ZA - GZ Tuchel 5-pol.	Standard	7S8SK046040330A00
	8 m	EDP	ZA - GZ Tuchel 5-pol.	Standard	7S8SK086040330A00
	4 m	EDP	ZA - GZ Tuchel 5-pol.	High Flex Leder	7S8SH046040330A00
	8 m	EDP	ZA - GZ Tuchel 5-pol.	High Flex Leder	7S8SH086040330A00
ABITIG® 200	4 m	EDP	ZA - GZ Tuchel 5-pol.	Standard	7T4SK046040330A00
	8 m	EDP	ZA - GZ Tuchel 5-pol.	Standard	7T4SK086040330A00
	4 m	EDP	ZA - GZ Tuchel 5-pol.	High Flex Leder	7T4SH046040330A00
	8 m	EDP	ZA - GZ Tuchel 5-pol.	High Flex Leder	7T4SH086040330A00
ABITIG® 200F	4 m	EDP	ZA - GZ Tuchel 5-pol.	Standard	7T4FK046040330A00
	8 m	EDP	ZA - GZ Tuchel 5-pol.	Standard	7T4FK086040330A00
	4 m	EDP	ZA - GZ Tuchel 5-pol.	High Flex Leder	7T4FH046040330A00
	8 m	EDP	ZA - GZ Tuchel 5-pol.	High Flex Leder	7T4FH086040330A00
ABITIG® 150	4 m	EDP	ZA - GZ Tuchel 5-pol.	Standard	7T6SK046040330A00
	8 m	EDP	ZA - GZ Tuchel 5-pol.	Standard	7T6SK086040330A00
	4 m	EDP	ZA - GZ Tuchel 5-pol.	High Flex Leder	7T6SH046040330A00
	8 m	EDP	ZA - GZ Tuchel 5-pol.	High Flex Leder	7T6SH086040330A00
ABITIG® 150F	4 m	EDP	ZA - GZ Tuchel 5-pol.	Standard	7T6FK046040330A00
	8 m	EDP	ZA - GZ Tuchel 5-pol.	Standard	7T6FK086040330A00
	4 m	EDP	ZA - GZ Tuchel 5-pol.	High Flex Leder	7T6FH046040330A00
	8 m	EDP	ZA - GZ Tuchel 5-pol.	High Flex Leder	7T6FH086040330A00

ABITIG®-Brennerpreisliste

passend für WIG-Stromquellen des Fabrikates „merkle“

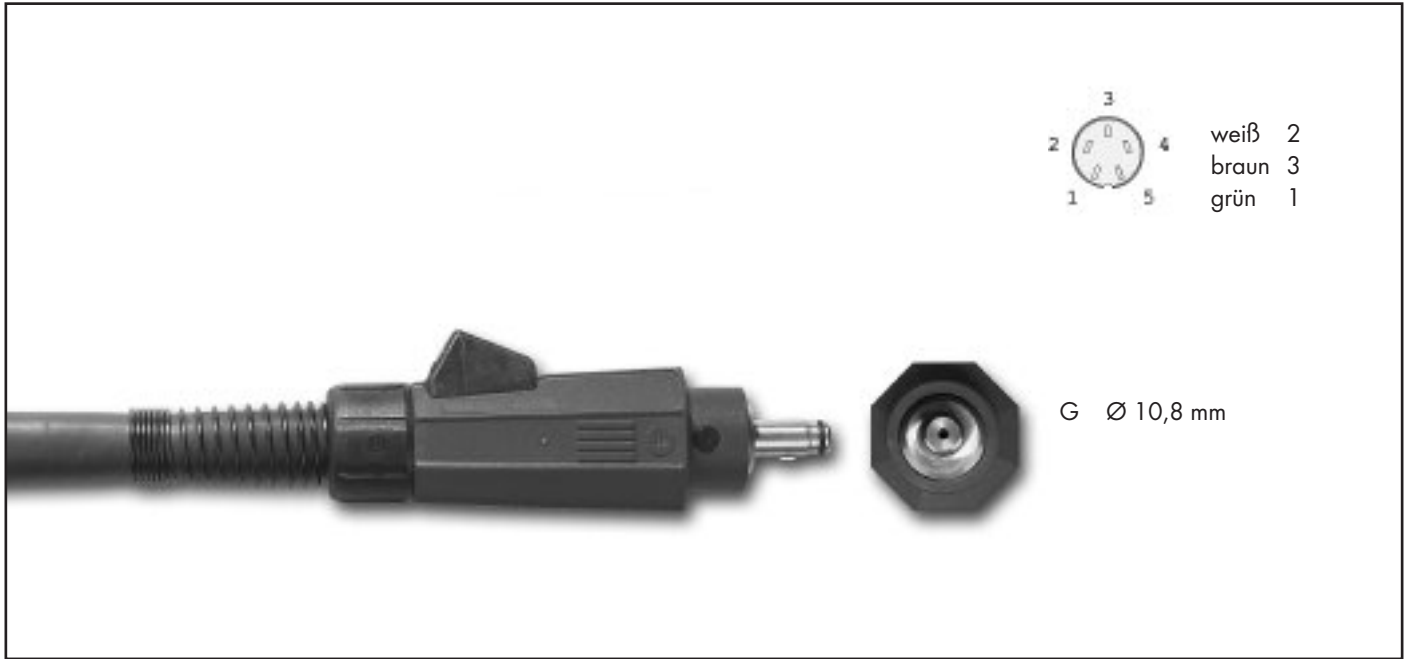

Brennertyp	Länge	Schalterfunktion	maschinenseitiger Anschluss	Schlauchpaketausführung	Bestellnummer
ABITIG® 9	4 m	DD	TCG Tuchel 5-pol.	Standard	7S1SK043023701A00
	8 m	DD	TCG Tuchel 5-pol.	Standard	7S1SK083023701A00
	4 m	DD	TCG Tuchel 5-pol.	High Flex Leder	7S1SH043023701A00
	8 m	DD	TCG Tuchel 5-pol.	High Flex Leder	7S1SH083023701A00

ABITIG® 9F	4 m	DD	TCG Tuchel 5-pol.	Standard	7S1FK043023701A00
	8 m	DD	TCG Tuchel 5-pol.	Standard	7S1FK083023701A00
	4 m	DD	TCG Tuchel 5-pol.	High Flex Leder	7S1FH043023701A00
	8 m	DD	TCG Tuchel 5-pol.	High Flex Leder	7S1FH083023701A00

ABITIG® 17	4 m	DD	TCG Tuchel 5-pol.	Standard	7S2SK043023701A00
	8 m	DD	TCG Tuchel 5-pol.	Standard	7S2SK083023701A00
	4 m	DD	TCG Tuchel 5-pol.	High Flex Leder	7S2SH043023701A00
	8 m	DD	TCG Tuchel 5-pol.	High Flex Leder	7S2SH083023701A00

ABITIG® 17F	4 m	DD	TCG Tuchel 5-pol.	Standard	7S2FK043023701A00
	8 m	DD	TCG Tuchel 5-pol.	Standard	7S2FK083023701A00
	4 m	DD	TCG Tuchel 5-pol.	High Flex Leder	7S2FH043023701A00
	8 m	DD	TCG Tuchel 5-pol.	High Flex Leder	7S2FH083023701A00

Technische Änderungen vorbehalten • Verkaufspreise = unverbindliche Preisempfehlung - Angebot freibleibend • © Copyright

ABITIG®-Brennerpreisliste

passend für WIG-Stromquellen des Fabrikates „merkle“

Brennertyp	Länge	Schalterfunktion	maschinenseitiger Anschluss	Schlauchpaketausführung	Bestellnummer
ABITIG® 26	4 m	DD	TCG Tuchel 5-pol.	Standard	7S3SK043023701A00
	8 m	DD	TCG Tuchel 5-pol.	Standard	7S3SK083023701A00
	4 m	DD	TCG Tuchel 5-pol.	High Flex Leder	7S3SH043023701A00
	8 m	DD	TCG Tuchel 5-pol.	High Flex Leder	7S3SH083023701A00

ABITIG® 26F	4 m	DD	TCG Tuchel 5-pol.	Standard	7S3FK043023701A00
	8 m	DD	TCG Tuchel 5-pol.	Standard	7S3FK083023701A00
	4 m	DD	TCG Tuchel 5-pol.	High Flex Leder	7S3FH043023701A00
	8 m	DD	TCG Tuchel 5-pol.	High Flex Leder	7S3FH083023701A00

ABITIG® 24G	4 m	DD	TCG Tuchel 5-pol.	Standard	7S8SK043023701A00
	8 m	DD	TCG Tuchel 5-pol.	Standard	7S8SK083023701A00
	4 m	DD	TCG Tuchel 5-pol.	High Flex Leder	7S8SH043023701A00
	8 m	DD	TCG Tuchel 5-pol.	High Flex Leder	7S8SH083023701A00

ABITIG® 200	4 m	DD	TCG Tuchel 5-pol.	Standard	7T4SK043023701A00
	8 m	DD	TCG Tuchel 5-pol.	Standard	7T4SK083023701A00
	4 m	DD	TCG Tuchel 5-pol.	High Flex Leder	7T4SH043023701A00
	8 m	DD	TCG Tuchel 5-pol.	High Flex Leder	7T4SH083023701A00

ABITIG® 200F	4 m	DD	TCG Tuchel 5-pol.	Standard	7T4FK043023701A00
	8 m	DD	TCG Tuchel 5-pol.	Standard	7T4FK083023701A00
	4 m	DD	TCG Tuchel 5-pol.	High Flex Leder	7T4FH043023701A00
	8 m	DD	TCG Tuchel 5-pol.	High Flex Leder	7T4FH083023701A00

ABITIG® 150	4 m	DD	TCG Tuchel 5-pol.	Standard	7T6SK043023701A00
	8 m	DD	TCG Tuchel 5-pol.	Standard	7T6SK083023701A00
	4 m	DD	TCG Tuchel 5-pol.	High Flex Leder	7T6SH043023701A00
	8 m	DD	TCG Tuchel 5-pol.	High Flex Leder	7T6SH083023701A00

ABITIG® 150F	4 m	DD	TCG Tuchel 5-pol.	Standard	7T6FK043023701A00
	8 m	DD	TCG Tuchel 5-pol.	Standard	7T6FK083023701A00
	4 m	DD	TCG Tuchel 5-pol.	High Flex Leder	7T6FH043023701A00
	8 m	DD	TCG Tuchel 5-pol.	High Flex Leder	7T6FH083023701A00

ABITIG®-Brennerpreisliste

passend für WIG-Stromquellen des Fabrikates „merkle“

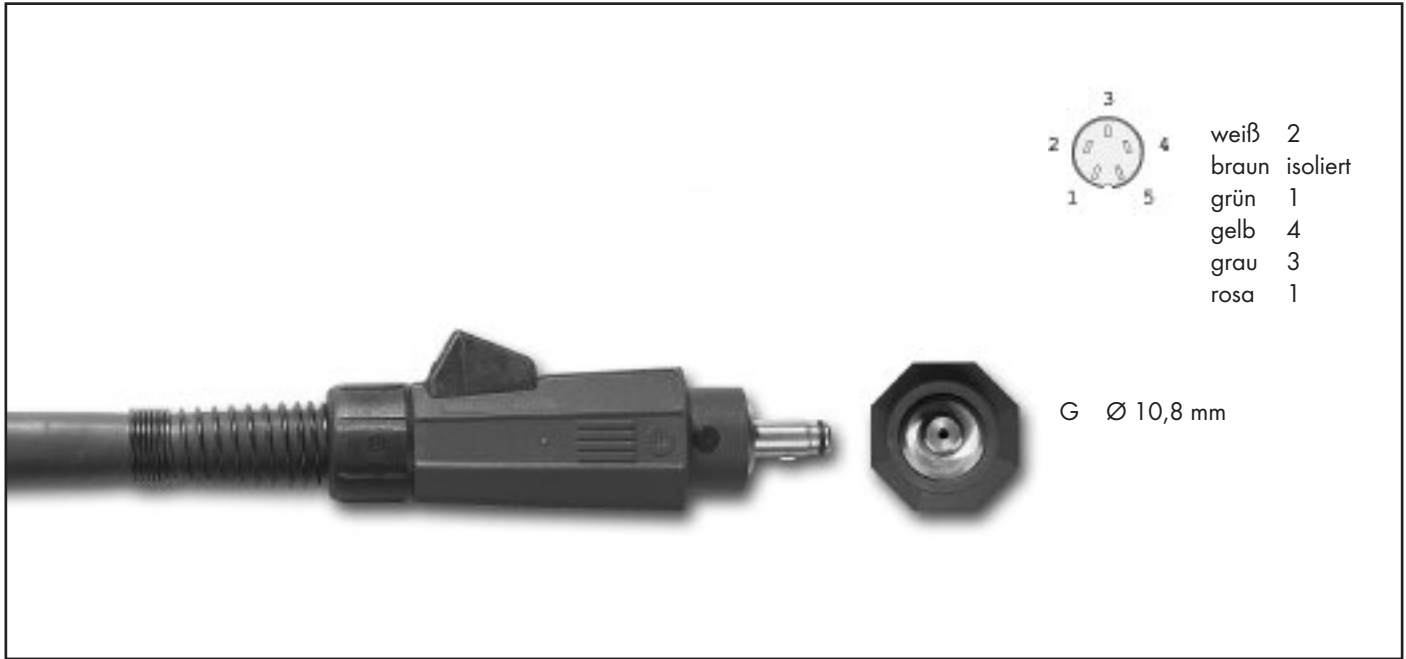

Brennertyp	Länge	Schalterfunktion	maschinenseitiger Anschluss	Schlauchpaketausführung	Bestellnummer
ABITIG® 9	4 m	EDP	TCG Tuchel 5-pol.	Standard	7S1SK046043730A00
	8 m	EDP	TCG Tuchel 5-pol.	Standard	7S1SK086043730A00
	4 m	EDP	TCG Tuchel 5-pol.	High Flex Leder	7S1SH046043730A00
	8 m	EDP	TCG Tuchel 5-pol.	High Flex Leder	7S1SH086043730A00

ABITIG® 9F	4 m	EDP	TCG Tuchel 5-pol.	Standard	7S1FK046043730A00
	8 m	EDP	TCG Tuchel 5-pol.	Standard	7S1FK086043730A00
	4 m	EDP	TCG Tuchel 5-pol.	High Flex Leder	7S1FH046043730A00
	8 m	EDP	TCG Tuchel 5-pol.	High Flex Leder	7S1FH086043730A00

ABITIG® 17	4 m	EDP	TCG Tuchel 5-pol.	Standard	7S2SK046043730A00
	8 m	EDP	TCG Tuchel 5-pol.	Standard	7S2SK086043730A00
	4 m	EDP	TCG Tuchel 5-pol.	High Flex Leder	7S2SH046043730A00
	8 m	EDP	TCG Tuchel 5-pol.	High Flex Leder	7S2SH086043730A00

ABITIG® 17F	4 m	EDP	TCG Tuchel 5-pol.	Standard	7S2FK046043730A00
	8 m	EDP	TCG Tuchel 5-pol.	Standard	7S2FK086043730A00
	4 m	EDP	TCG Tuchel 5-pol.	High Flex Leder	7S2FH046043730A00
	8 m	EDP	TCG Tuchel 5-pol.	High Flex Leder	7S2FH086043730A00

Technische Änderungen vorbehalten • Verkaufspreise = unverbindliche Preisempfehlung - Angebot freibleibend • © Copyright

ABITIG®-Brennerpreisliste

passend für WIG-Stromquellen des Fabrikates „merkle“

Brennertyp	Länge	Schalterfunktion	maschinenseitiger Anschluss	Schlauchpaketausführung	Bestellnummer
ABITIG® 26	4 m	EDP	TCG Tuchel 5-pol.	Standard	7S3SK046043730A00
	8 m	EDP	TCG Tuchel 5-pol.	Standard	7S3SK086043730A00
	4 m	EDP	TCG Tuchel 5-pol.	High Flex Leder	7S3SH046043730A00
	8 m	EDP	TCG Tuchel 5-pol.	High Flex Leder	7S3SH086043730A00
ABITIG® 26F	4 m	EDP	TCG Tuchel 5-pol.	Standard	7S3FK046043730A00
	8 m	EDP	TCG Tuchel 5-pol.	Standard	7S3FK086043730A00
	4 m	EDP	TCG Tuchel 5-pol.	High Flex Leder	7S3FH046043730A00
	8 m	EDP	TCG Tuchel 5-pol.	High Flex Leder	7S3FH086043730A00
ABITIG® 24G	4 m	EDP	TCG Tuchel 5-pol.	Standard	7S8SK046043730A00
	8 m	EDP	TCG Tuchel 5-pol.	Standard	7S8SK086043730A00
	4 m	EDP	TCG Tuchel 5-pol.	High Flex Leder	7S8SH046043730A00
	8 m	EDP	TCG Tuchel 5-pol.	High Flex Leder	7S8SH086043730A00
ABITIG® 200	4 m	EDP	TCG Tuchel 5-pol.	Standard	7T4SK046043730A00
	8 m	EDP	TCG Tuchel 5-pol.	Standard	7T4SK086043730A00
	4 m	EDP	TCG Tuchel 5-pol.	High Flex Leder	7T4SH046043730A00
	8 m	EDP	TCG Tuchel 5-pol.	High Flex Leder	7T4SH086043730A00
ABITIG® 200F	4 m	EDP	TCG Tuchel 5-pol.	Standard	7T4FK046043730A00
	8 m	EDP	TCG Tuchel 5-pol.	Standard	7T4FK086043730A00
	4 m	EDP	TCG Tuchel 5-pol.	High Flex Leder	7T4FH046043730A00
	8 m	EDP	TCG Tuchel 5-pol.	High Flex Leder	7T4FH086043730A00
ABITIG® 150	4 m	EDP	TCG Tuchel 5-pol.	Standard	7T6SK046043730A00
	8 m	EDP	TCG Tuchel 5-pol.	Standard	7T6SK086043730A00
	4 m	EDP	TCG Tuchel 5-pol.	High Flex Leder	7T6SH046043730A00
	8 m	EDP	TCG Tuchel 5-pol.	High Flex Leder	7T6SH086043730A00
ABITIG® 150F	4 m	EDP	TCG Tuchel 5-pol.	Standard	7T6FK046043730A00
	8 m	EDP	TCG Tuchel 5-pol.	Standard	7T6FK086043730A00
	4 m	EDP	TCG Tuchel 5-pol.	High Flex Leder	7T6FH046043730A00
	8 m	EDP	TCG Tuchel 5-pol.	High Flex Leder	7T6FH086043730A00

ABITIG®-Brennerpreisliste

passend für WIG-Stromquellen des Fabrikates „merkle“ PU 250/300 K



Brennertyp	Länge	Schalterfunktion	maschinenseitiger Anschluss	Schlauchpaketausführung	Bestellnummer
ABITIG® 9	4 m	ED	MAG - ZA	Standard	7S1SK043013496A00
	8 m	ED	MAG - ZA	Standard	7S1SK083013496A00
	4 m	ED	MAG - ZA	High Flex Leder	7S1SH043013496A00
	8 m	ED	MAG - ZA	High Flex Leder	7S1SH083013496A00
ABITIG® 9F	4 m	ED	MAG - ZA	Standard	7S1FK043013496A00
	8 m	ED	MAG - ZA	Standard	7S1FK083013496A00
	4 m	ED	MAG - ZA	High Flex Leder	7S1FH043013496A00
	8 m	ED	MAG - ZA	High Flex Leder	7S1FH083013496A00
ABITIG® 17	4 m	ED	MAG - ZA	Standard	7S2SK043013496A00
	8 m	ED	MAG - ZA	Standard	7S2SK083013496A00
	4 m	ED	MAG - ZA	High Flex Leder	7S2SH043013496A00
	8 m	ED	MAG - ZA	High Flex Leder	7S2SH083013496A00
ABITIG® 17F	4 m	ED	MAG - ZA	Standard	7S2FK043013496A00
	8 m	ED	MAG - ZA	Standard	7S2FK083013496A00
	4 m	ED	MAG - ZA	High Flex Leder	7S2FH043013496A00
	8 m	ED	MAG - ZA	High Flex Leder	7S2FH083013496A00

Technische Änderungen vorbehalten • Verkaufspreise = unverbindliche Preisempfehlung - Angebot freibleibend • © Copyright

ABITIG®-Brennerpreisliste

passend für WIG-Stromquellen des Fabrikates „merkle“ PU 250/300 K

Brennertyp	Länge	Schalterfunktion	maschinenseitiger Anschluss	Schlauchpaketausführung	Bestellnummer
ABITIG® 26	4 m	ED	MAG - ZA	Standard	7S3SK043013496A00
	8 m	ED	MAG - ZA	Standard	7S3SK083013496A00
	4 m	ED	MAG - ZA	High Flex Leder	7S3SH043013496A00
	8 m	ED	MAG - ZA	High Flex Leder	7S3SH083013496A00
ABITIG® 26F	4 m	ED	MAG - ZA	Standard	7S3FK043013496A00
	8 m	ED	MAG - ZA	Standard	7S3FK083013496A00
	4 m	ED	MAG - ZA	High Flex Leder	7S3FH043013496A00
	8 m	ED	MAG - ZA	High Flex Leder	7S3FH083013496A00
ABITIG® 24G	4 m	ED	MAG - ZA	Standard	7S8SK043013496A00
	8 m	ED	MAG - ZA	Standard	7S8SK083013496A00
	4 m	ED	MAG - ZA	High Flex Leder	7S8SH043013496A00
	8 m	ED	MAG - ZA	High Flex Leder	7S8SH083013496A00
ABITIG® 200	4 m	ED	MAG - ZA	Standard	7T4SK043013496A00
	8 m	ED	MAG - ZA	Standard	7T4SK083013496A00
	4 m	ED	MAG - ZA	High Flex Leder	7T4SH043013496A00
	8 m	ED	MAG - ZA	High Flex Leder	7T4SH083013496A00
ABITIG® 200F	4 m	ED	MAG - ZA	Standard	7T4FK043013496A00
	8 m	ED	MAG - ZA	Standard	7T4FK083013496A00
	4 m	ED	MAG - ZA	High Flex Leder	7T4FH043013496A00
	8 m	ED	MAG - ZA	High Flex Leder	7T4FH083013496A00
ABITIG® 150	4 m	ED	MAG - ZA	Standard	7T6SK043013496A00
	8 m	ED	MAG - ZA	Standard	7T6SK083013496A00
	4 m	ED	MAG - ZA	High Flex Leder	7T6SH043013496A00
	8 m	ED	MAG - ZA	High Flex Leder	7T6SH083013496A00
ABITIG® 150F	4 m	ED	MAG - ZA	Standard	7T6FK043013496A00
	8 m	ED	MAG - ZA	Standard	7T6FK083013496A00
	4 m	ED	MAG - ZA	High Flex Leder	7T6FH043013496A00
	8 m	ED	MAG - ZA	High Flex Leder	7T6FH083013496A00

ABITIG®-Brennerpreisliste

passend für WIG-Stromquellen des Fabrikates „merkle“



Brennertyp	Länge	Schalterfunktion	maschinenseitiger Anschluss	Schlauchpaketausführung	Bestellnummer
ABITIG® 18	4 m	ED/DD	ZA - WZ-0 Tuchel 3-pol.	Standard	7S4SK043020313A12
	8 m	ED/DD	ZA - WZ-0 Tuchel 3-pol.	Standard	7S4SK083020313A12
	4 m	ED/DD	ZA - WZ-0 Tuchel 3-pol.	High Flex Leder	7S4SH043020313A12
	8 m	ED/DD	ZA - WZ-0 Tuchel 3-pol.	High Flex Leder	7S4SH083020313A12

ABITIG® 18F	4 m	ED/DD	ZA - WZ-0 Tuchel 3-pol.	Standard	7S4FK043020313A12
	8 m	ED/DD	ZA - WZ-0 Tuchel 3-pol.	Standard	7S4FK083020313A12
	4 m	ED/DD	ZA - WZ-0 Tuchel 3-pol.	High Flex Leder	7S4FH043020313A12
	8 m	ED/DD	ZA - WZ-0 Tuchel 3-pol.	High Flex Leder	7S4FH083020313A12

ABITIG® 20	4 m	ED/DD	ZA - WZ-0 Tuchel 3-pol.	Standard	7S5SK043020313A12
	8 m	ED/DD	ZA - WZ-0 Tuchel 3-pol.	Standard	7S5SK083020313A12
	4 m	ED/DD	ZA - WZ-0 Tuchel 3-pol.	High Flex Leder	7S5SH043020313A12
	8 m	ED/DD	ZA - WZ-0 Tuchel 3-pol.	High Flex Leder	7S5SH083020313A12

ABITIG® 20F	4 m	ED/DD	ZA - WZ-0 Tuchel 3-pol.	Standard	7S5FK043020313A12
	8 m	ED/DD	ZA - WZ-0 Tuchel 3-pol.	Standard	7S5FK083020313A12
	4 m	ED/DD	ZA - WZ-0 Tuchel 3-pol.	High Flex Leder	7S5FH043020313A12
	8 m	ED/DD	ZA - WZ-0 Tuchel 3-pol.	High Flex Leder	7S5FH083020313A12

Technische Änderungen vorbehalten • Verkaufspreise = unverbindliche Preisempfehlung - Angebot freibleibend • © Copyright

ABITIG®-Brennerpreisliste

passend für WIG-Stromquellen des Fabrikates „merkle“

Brennertyp	Länge	Schalterfunktion	maschinenseitiger Anschluss	Schlauchpaketausführung	Bestellnummer
ABITIG® 12-1	4 m	ED/DD	ZA - WZ-0 Tuchel 3-pol.	Standard	7S6SK043020313A12
	8 m	ED/DD	ZA - WZ-0 Tuchel 3-pol.	Standard	7S6SK083020313A12
	4 m	ED/DD	ZA - WZ-0 Tuchel 3-pol.	High Flex Leder	7S6SH043020313A12
	8 m	ED/DD	ZA - WZ-0 Tuchel 3-pol.	High Flex Leder	7S6SH083020313A12

ABITIG® 18SC	4 m	ED/DD	ZA - WZ-0 Tuchel 3-pol.	Standard	7S7SK043020313A12
	8 m	ED/DD	ZA - WZ-0 Tuchel 3-pol.	Standard	7S7SK083020313A12
	4 m	ED/DD	ZA - WZ-0 Tuchel 3-pol.	High Flex Leder	7S7SH043020313A12
	8 m	ED/DD	ZA - WZ-0 Tuchel 3-pol.	High Flex Leder	7S7SH083020313A12

ABITIG® 24W	4 m	ED/DD	ZA - WZ-0 Tuchel 3-pol.	Standard	7S9SK043020313A12
	8 m	ED/DD	ZA - WZ-0 Tuchel 3-pol.	Standard	7S9SK083020313A12
	4 m	ED/DD	ZA - WZ-0 Tuchel 3-pol.	High Flex Leder	7S9SH043020313A12
	8 m	ED/DD	ZA - WZ-0 Tuchel 3-pol.	High Flex Leder	7S9SH083020313A12

ABITIG® 450W	4 m	ED/DD	ZA - WZ-0 Tuchel 3-pol.	Standard	7T5SK043020313A12
	8 m	ED/DD	ZA - WZ-0 Tuchel 3-pol.	Standard	7T5SK083020313A12
	4 m	ED/DD	ZA - WZ-0 Tuchel 3-pol.	High Flex Leder	7T5SH043020313A12
	8 m	ED/DD	ZA - WZ-0 Tuchel 3-pol.	High Flex Leder	7T5SH083020313A12

ABITIG® 260W	4 m	ED/DD	ZA - WZ-0 Tuchel 3-pol.	Standard	7T7SK043020313A12
	8 m	ED/DD	ZA - WZ-0 Tuchel 3-pol.	Standard	7T7SK083020313A12
	4 m	ED/DD	ZA - WZ-0 Tuchel 3-pol.	High Flex Leder	7T7SH043020313A12
	8 m	ED/DD	ZA - WZ-0 Tuchel 3-pol.	High Flex Leder	7T7SH083020313A12

ABITIG® 450W SC	4 m	ED/DD	ZA - WZ-0 Tuchel 3-pol.	Standard	
	8 m	ED/DD	ZA - WZ-0 Tuchel 3-pol.	Standard	
	4 m	ED/DD	ZA - WZ-0 Tuchel 3-pol.	High Flex Leder	7T8SH043020313A12
	8 m	ED/DD	ZA - WZ-0 Tuchel 3-pol.	High Flex Leder	7T8SH083020313A12

ABITIG®-Brennerpreisliste

passend für WIG-Stromquellen des Fabrikates „merkle“



Brennertyp	Länge	Schalterfunktion	maschinenseitiger Anschluss	Schlauchpaketausführung	Bestellnummer
ABITIG® 18	4 m	DD	ZA - WZ-0 Tuchel 5-pol.	Standard	7S4SK043020301A12
	8 m	DD	ZA - WZ-0 Tuchel 5-pol.	Standard	7S4SK083020301A12
	4 m	DD	ZA - WZ-0 Tuchel 5-pol.	High Flex Leder	7S4SH043020301A12
	8 m	DD	ZA - WZ-0 Tuchel 5-pol.	High Flex Leder	7S4SH083020301A12

ABITIG® 18F	4 m	DD	ZA - WZ-0 Tuchel 5-pol.	Standard	7S4FK043020301A12
	8 m	DD	ZA - WZ-0 Tuchel 5-pol.	Standard	7S4FK083020301A12
	4 m	DD	ZA - WZ-0 Tuchel 5-pol.	High Flex Leder	7S4FH043020301A12
	8 m	DD	ZA - WZ-0 Tuchel 5-pol.	High Flex Leder	7S4FH083020301A12

ABITIG® 20	4 m	DD	ZA - WZ-0 Tuchel 5-pol.	Standard	7S5SK043020301A12
	8 m	DD	ZA - WZ-0 Tuchel 5-pol.	Standard	7S5SK083020301A12
	4 m	DD	ZA - WZ-0 Tuchel 5-pol.	High Flex Leder	7S5SH043020301A12
	8 m	DD	ZA - WZ-0 Tuchel 5-pol.	High Flex Leder	7S5SH083020301A12

ABITIG® 20F	4 m	DD	ZA - WZ-0 Tuchel 5-pol.	Standard	7S5FK043020301A12
	8 m	DD	ZA - WZ-0 Tuchel 5-pol.	Standard	7S5FK083020301A12
	4 m	DD	ZA - WZ-0 Tuchel 5-pol.	High Flex Leder	7S5FH043020301A12
	8 m	DD	ZA - WZ-0 Tuchel 5-pol.	High Flex Leder	7S5FH083020301A12

Technische Änderungen vorbehalten • Verkaufspreise = unverbindliche Preisempfehlung - Angebot freibleibend • © Copyright

ABITIG®-Brennerpreisliste

passend für WIG-Stromquellen des Fabrikates „merkle“

Brennertyp	Länge	Schalterfunktion	maschinenseitiger Anschluss	Schlauchpaketausführung	Bestellnummer
ABITIG® 12-1	4 m	DD	ZA - WZ-0 Tuchel 5-pol.	Standard	7S6SK043020301A12
	8 m	DD	ZA - WZ-0 Tuchel 5-pol.	Standard	7S6SK083020301A12
	4 m	DD	ZA - WZ-0 Tuchel 5-pol.	High Flex Leder	7S6SH043020301A12
	8 m	DD	ZA - WZ-0 Tuchel 5-pol.	High Flex Leder	7S6SH083020301A12
ABITIG® 18SC	4 m	DD	ZA - WZ-0 Tuchel 5-pol.	Standard	7S7SK043020301A12
	8 m	DD	ZA - WZ-0 Tuchel 5-pol.	Standard	7S7SK083020301A12
	4 m	DD	ZA - WZ-0 Tuchel 5-pol.	High Flex Leder	7S7SH043020301A12
	8 m	DD	ZA - WZ-0 Tuchel 5-pol.	High Flex Leder	7S7SH083020301A12
ABITIG® 24W	4 m	DD	ZA - WZ-0 Tuchel 5-pol.	Standard	7S9SK043020301A12
	8 m	DD	ZA - WZ-0 Tuchel 5-pol.	Standard	7S9SK083020301A12
	4 m	DD	ZA - WZ-0 Tuchel 5-pol.	High Flex Leder	7S9SH043020301A12
	8 m	DD	ZA - WZ-0 Tuchel 5-pol.	High Flex Leder	7S9SH083020301A12
ABITIG® 450W	4 m	DD	ZA - WZ-0 Tuchel 5-pol.	Standard	7T5SK043020301A12
	8 m	DD	ZA - WZ-0 Tuchel 5-pol.	Standard	7T5SK083020301A12
	4 m	DD	ZA - WZ-0 Tuchel 5-pol.	High Flex Leder	7T5SH043020301A12
	8 m	DD	ZA - WZ-0 Tuchel 5-pol.	High Flex Leder	7T5SH083020301A12
ABITIG® 260W	4 m	DD	ZA - WZ-0 Tuchel 5-pol.	Standard	7T7SK043020301A12
	8 m	DD	ZA - WZ-0 Tuchel 5-pol.	Standard	7T7SK083020301A12
	4 m	DD	ZA - WZ-0 Tuchel 5-pol.	High Flex Leder	7T7SH043020301A12
	8 m	DD	ZA - WZ-0 Tuchel 5-pol.	High Flex Leder	7T7SH083020301A12
ABITIG® 450W SC	4 m	DD	ZA - WZ-0 Tuchel 5-pol.	Standard	
	8 m	DD	ZA - WZ-0 Tuchel 5-pol.	Standard	
	4 m	DD	ZA - WZ-0 Tuchel 5-pol.	High Flex Leder	7T8SH043020301A12
	8 m	DD	ZA - WZ-0 Tuchel 5-pol.	High Flex Leder	7T8SH083020301A12

ABITIG®-Brennerpreisliste

passend für WIG-Stromquellen des Fabrikates „merkle“



Brennertyp	Länge	Schalterfunktion	maschinenseitiger Anschluss	Schlauchpaketausführung	Bestellnummer
ABITIG® 18	4 m	EDP	ZA - WZ-0 Tuchel 5-pol.	Standard	7S4SK046040330A12
	8 m	EDP	ZA - WZ-0 Tuchel 5-pol.	Standard	7S4SK086040330A12
	4 m	EDP	ZA - WZ-0 Tuchel 5-pol.	High Flex Leder	7S4SH046040330A12
	8 m	EDP	ZA - WZ-0 Tuchel 5-pol.	High Flex Leder	7S4SH086040330A12
ABITIG® 18F	4 m	EDP	ZA - WZ-0 Tuchel 5-pol.	Standard	7S4FK046040330A12
	8 m	EDP	ZA - WZ-0 Tuchel 5-pol.	Standard	7S4FK086040330A12
	4 m	EDP	ZA - WZ-0 Tuchel 5-pol.	High Flex Leder	7S4FH046040330A12
	8 m	EDP	ZA - WZ-0 Tuchel 5-pol.	High Flex Leder	7S4FH086040330A12
ABITIG® 20	4 m	EDP	ZA - WZ-0 Tuchel 5-pol.	Standard	7S5SK046040330A12
	8 m	EDP	ZA - WZ-0 Tuchel 5-pol.	Standard	7S5SK086040330A12
	4 m	EDP	ZA - WZ-0 Tuchel 5-pol.	High Flex Leder	7S5SH046040330A12
	8 m	EDP	ZA - WZ-0 Tuchel 5-pol.	High Flex Leder	7S5SH086040330A12
ABITIG® 20F	4 m	EDP	ZA - WZ-0 Tuchel 5-pol.	Standard	7S5FK046040330A12
	8 m	EDP	ZA - WZ-0 Tuchel 5-pol.	Standard	7S5FK086040330A12
	4 m	EDP	ZA - WZ-0 Tuchel 5-pol.	High Flex Leder	7S5FH046040330A12
	8 m	EDP	ZA - WZ-0 Tuchel 5-pol.	High Flex Leder	7S5FH086040330A12

Technische Änderungen vorbehalten • Verkaufspreise = unverbindliche Preisempfehlung - Angebot freibleibend • © Copyright

ABITIG®-Brennerpreisliste

passend für WIG-Stromquellen des Fabrikates „merkle“

Brennertyp	Länge	Schalterfunktion	maschinenseitiger Anschluss	Schlauchpaketausführung	Bestellnummer
ABITIG® 12-1	4 m	EDP	ZA - WZ-0 Tuchel 5-pol.	Standard	7S6SK046040330A12
	8 m	EDP	ZA - WZ-0 Tuchel 5-pol.	Standard	7S6SK086040330A12
	4 m	EDP	ZA - WZ-0 Tuchel 5-pol.	High Flex Leder	7S6SH046040330A12
	8 m	EDP	ZA - WZ-0 Tuchel 5-pol.	High Flex Leder	7S6SH086040330A12
ABITIG® 18SC	4 m	EDP	ZA - WZ-0 Tuchel 5-pol.	Standard	7S7SK046040330A12
	8 m	EDP	ZA - WZ-0 Tuchel 5-pol.	Standard	7S7SK086040330A12
	4 m	EDP	ZA - WZ-0 Tuchel 5-pol.	High Flex Leder	7S7SH046040330A12
	8 m	EDP	ZA - WZ-0 Tuchel 5-pol.	High Flex Leder	7S7SH086040330A12
ABITIG® 24W	4 m	EDP	ZA - WZ-0 Tuchel 5-pol.	Standard	7S9SK046040330A12
	8 m	EDP	ZA - WZ-0 Tuchel 5-pol.	Standard	7S9SK086040330A12
	4 m	EDP	ZA - WZ-0 Tuchel 5-pol.	High Flex Leder	7S9SH046040330A12
	8 m	EDP	ZA - WZ-0 Tuchel 5-pol.	High Flex Leder	7S9SH086040330A12
ABITIG® 450W	4 m	EDP	ZA - WZ-0 Tuchel 5-pol.	Standard	7T5SK046040330A12
	8 m	EDP	ZA - WZ-0 Tuchel 5-pol.	Standard	7T5SK086040330A12
	4 m	EDP	ZA - WZ-0 Tuchel 5-pol.	High Flex Leder	7T5SH046040330A12
	8 m	EDP	ZA - WZ-0 Tuchel 5-pol.	High Flex Leder	7T5SH086040330A12
ABITIG® 260W	4 m	EDP	ZA - WZ-0 Tuchel 5-pol.	Standard	7T7SK046040330A12
	8 m	EDP	ZA - WZ-0 Tuchel 5-pol.	Standard	7T7SK086040330A12
	4 m	EDP	ZA - WZ-0 Tuchel 5-pol.	High Flex Leder	7T7SH046040330A12
	8 m	EDP	ZA - WZ-0 Tuchel 5-pol.	High Flex Leder	7T7SH086040330A12
ABITIG® 450W SC	4 m	EDP	ZA - WZ-0 Tuchel 5-pol.	Standard	
	8 m	EDP	ZA - WZ-0 Tuchel 5-pol.	Standard	
	4 m	EDP	ZA - WZ-0 Tuchel 5-pol.	High Flex Leder	7T8SH046040330A12
	8 m	EDP	ZA - WZ-0 Tuchel 5-pol.	High Flex Leder	7T8SH086040330A12

ABITIG®-Brennerpreisliste

passend für WIG-Stromquellen des Fabrikates „merkle“



Brennertyp	Länge	Schalterfunktion	maschinenseitiger Anschluss	Schlauchpaketausführung	Bestellnummer
ABITIG® 18	4 m	DD	TCG Tuchel 5-pol.	Standard	7S4SK043023701A12
	8 m	DD	TCG Tuchel 5-pol.	Standard	7S4SK083023701A12
	4 m	DD	TCG Tuchel 5-pol.	High Flex Leder	7S4SH043023701A12
	8 m	DD	TCG Tuchel 5-pol.	High Flex Leder	7S4SH083023701A12
ABITIG® 18F	4 m	DD	TCG Tuchel 5-pol.	Standard	7S4FK043023701A12
	8 m	DD	TCG Tuchel 5-pol.	Standard	7S4FK083023701A12
	4 m	DD	TCG Tuchel 5-pol.	High Flex Leder	7S4FH043023701A12
	8 m	DD	TCG Tuchel 5-pol.	High Flex Leder	7S4FH083023701A12
ABITIG® 20	4 m	DD	TCG Tuchel 5-pol.	Standard	7S5SK043023701A12
	8 m	DD	TCG Tuchel 5-pol.	Standard	7S5SK083023701A12
	4 m	DD	TCG Tuchel 5-pol.	High Flex Leder	7S5SH043023701A12
	8 m	DD	TCG Tuchel 5-pol.	High Flex Leder	7S5SH083023701A12
ABITIG® 20F	4 m	DD	TCG Tuchel 5-pol.	Standard	7S5FK043023701A12
	8 m	DD	TCG Tuchel 5-pol.	Standard	7S5FK083023701A12
	4 m	DD	TCG Tuchel 5-pol.	High Flex Leder	7S5FH043023701A12
	8 m	DD	TCG Tuchel 5-pol.	High Flex Leder	7S5FH083023701A12

Technische Änderungen vorbehalten • Verkaufspreise = unverbindliche Preisempfehlung - Angebot freibleibend • © Copyright

ABITIG®-Brennerpreisliste

passend für WIG-Stromquellen des Fabrikates „merkle“

Brennertyp	Länge	Schalterfunktion	maschinenseitiger Anschluss	Schlauchpaketausführung	Bestellnummer
ABITIG® 12-1	4 m	DD	TCG Tuchel 5-pol.	Standard	7S6SK043023701A12
	8 m	DD	TCG Tuchel 5-pol.	Standard	7S6SK083023701A12
	4 m	DD	TCG Tuchel 5-pol.	High Flex Leder	7S6SH043023701A12
	8 m	DD	TCG Tuchel 5-pol.	High Flex Leder	7S6SH083023701A12
ABITIG® 18SC	4 m	DD	TCG Tuchel 5-pol.	Standard	7S7SK043023701A12
	8 m	DD	TCG Tuchel 5-pol.	Standard	7S7SK083023701A12
	4 m	DD	TCG Tuchel 5-pol.	High Flex Leder	7S7SH043023701A12
	8 m	DD	TCG Tuchel 5-pol.	High Flex Leder	7S7SH083023701A12
ABITIG® 24W	4 m	DD	TCG Tuchel 5-pol.	Standard	7S9SK043023701A12
	8 m	DD	TCG Tuchel 5-pol.	Standard	7S9SK083023701A12
	4 m	DD	TCG Tuchel 5-pol.	High Flex Leder	7S9SH043023701A12
	8 m	DD	TCG Tuchel 5-pol.	High Flex Leder	7S9SH083023701A12
ABITIG® 450W	4 m	DD	TCG Tuchel 5-pol.	Standard	7T5SK043023701A12
	8 m	DD	TCG Tuchel 5-pol.	Standard	7T5SK083023701A12
	4 m	DD	TCG Tuchel 5-pol.	High Flex Leder	7T5SH043023701A12
	8 m	DD	TCG Tuchel 5-pol.	High Flex Leder	7T5SH083023701A12
ABITIG® 260W	4 m	DD	TCG Tuchel 5-pol.	Standard	7T7SK043023701A12
	8 m	DD	TCG Tuchel 5-pol.	Standard	7T7SK083023701A12
	4 m	DD	TCG Tuchel 5-pol.	High Flex Leder	7T7SH043023701A12
	8 m	DD	TCG Tuchel 5-pol.	High Flex Leder	7T7SH083023701A12
ABITIG® 450W SC	4 m	DD	TCG Tuchel 5-pol.	Standard	
	8 m	DD	TCG Tuchel 5-pol.	Standard	
	4 m	DD	TCG Tuchel 5-pol.	High Flex Leder	7T8SH043023701A12
	8 m	DD	TCG Tuchel 5-pol.	High Flex Leder	7T8SH083023701A12

ABITIG®-Brennerpreisliste

passend für WIG-Stromquellen des Fabrikates „merkle“



Brennertyp	Länge	Schalterfunktion	maschinenseitiger Anschluss	Schlauchpaketausführung	Bestellnummer
ABITIG® 18	4 m	EDP	TCG Tuchel 5-pol.	Standard	7S4SK046043730A12
	8 m	EDP	TCG Tuchel 5-pol.	Standard	7S4SK086043730A12
	4 m	EDP	TCG Tuchel 5-pol.	High Flex Leder	7S4SH046043730A12
	8 m	EDP	TCG Tuchel 5-pol.	High Flex Leder	7S4SH086043730A12
ABITIG® 18F	4 m	EDP	TCG Tuchel 5-pol.	Standard	7S4FK046043730A12
	8 m	EDP	TCG Tuchel 5-pol.	Standard	7S4FK086043730A12
	4 m	EDP	TCG Tuchel 5-pol.	High Flex Leder	7S4FH046043730A12
	8 m	EDP	TCG Tuchel 5-pol.	High Flex Leder	7S4FH086043730A12
ABITIG® 20	4 m	EDP	TCG Tuchel 5-pol.	Standard	7S5SK046043730A12
	8 m	EDP	TCG Tuchel 5-pol.	Standard	7S5SK086043730A12
	4 m	EDP	TCG Tuchel 5-pol.	High Flex Leder	7S5SH046043730A12
	8 m	EDP	TCG Tuchel 5-pol.	High Flex Leder	7S5SH086043730A12
ABITIG® 20F	4 m	EDP	TCG Tuchel 5-pol.	Standard	7S5FK046043730A12
	8 m	EDP	TCG Tuchel 5-pol.	Standard	7S5FK086043730A12
	4 m	EDP	TCG Tuchel 5-pol.	High Flex Leder	7S5FH046043730A12
	8 m	EDP	TCG Tuchel 5-pol.	High Flex Leder	7S5FH086043730A12

Technische Änderungen vorbehalten • Verkaufspreise = unverbindliche Preisempfehlung - Angebot freibleibend • © Copyright

ABITIG®-Brennerpreisliste

passend für WIG-Stromquellen des Fabrikates „merkle“

Brennertyp	Länge	Schalterfunktion	maschinenseitiger Anschluss	Schlauchpaketausführung	Bestellnummer
ABITIG® 12-1	4 m	EDP	TCG Tuchel 5-pol.	Standard	7S6SK046043730A12
	8 m	EDP	TCG Tuchel 5-pol.	Standard	7S6SK086043730A12
	4 m	EDP	TCG Tuchel 5-pol.	High Flex Leder	7S6SH046043730A12
	8 m	EDP	TCG Tuchel 5-pol.	High Flex Leder	7S6SH086043730A12

ABITIG® 18SC	4 m	EDP	TCG Tuchel 5-pol.	Standard	7S7SK046043730A12
	8 m	EDP	TCG Tuchel 5-pol.	Standard	7S7SK086043730A12
	4 m	EDP	TCG Tuchel 5-pol.	High Flex Leder	7S7SH046043730A12
	8 m	EDP	TCG Tuchel 5-pol.	High Flex Leder	7S7SH086043730A12

ABITIG® 24W	4 m	EDP	TCG Tuchel 5-pol.	Standard	7S9SK046043730A12
	8 m	EDP	TCG Tuchel 5-pol.	Standard	7S9SK086043730A12
	4 m	EDP	TCG Tuchel 5-pol.	High Flex Leder	7S9SH046043730A12
	8 m	EDP	TCG Tuchel 5-pol.	High Flex Leder	7S9SH086043730A12

ABITIG® 450W	4 m	EDP	TCG Tuchel 5-pol.	Standard	7T5SK046043730A12
	8 m	EDP	TCG Tuchel 5-pol.	Standard	7T5SK086043730A12
	4 m	EDP	TCG Tuchel 5-pol.	High Flex Leder	7T5SH046043730A12
	8 m	EDP	TCG Tuchel 5-pol.	High Flex Leder	7T5SH086043730A12

ABITIG® 260W	4 m	EDP	TCG Tuchel 5-pol.	Standard	7T7SK046043730A12
	8 m	EDP	TCG Tuchel 5-pol.	Standard	7T7SK086043730A12
	4 m	EDP	TCG Tuchel 5-pol.	High Flex Leder	7T7SH046043730A12
	8 m	EDP	TCG Tuchel 5-pol.	High Flex Leder	7T7SH086043730A12

ABITIG® 450W SC	4 m	EDP	TCG Tuchel 5-pol.	Standard	
	8 m	EDP	TCG Tuchel 5-pol.	Standard	
	4 m	EDP	TCG Tuchel 5-pol.	High Flex Leder	7T8SH046043730A12
	8 m	EDP	TCG Tuchel 5-pol.	High Flex Leder	7T8SH086043730A12

ABITIG®-Brennerpreisliste

passend für WIG-Stromquellen des Fabrikates „messer-lincoln“

Für dieses Gerätefabrikat ist in der Bestellnummer und somit auch im Lieferumfang das Ansteuermodul BIS-10 enthalten. Das Ansteuermodul BIS-10 enthält im Gegensatz zu BIS-02 die verstärkte Schalterausführung (2x) wegen der geräteabhängigen höheren Schaltströme.

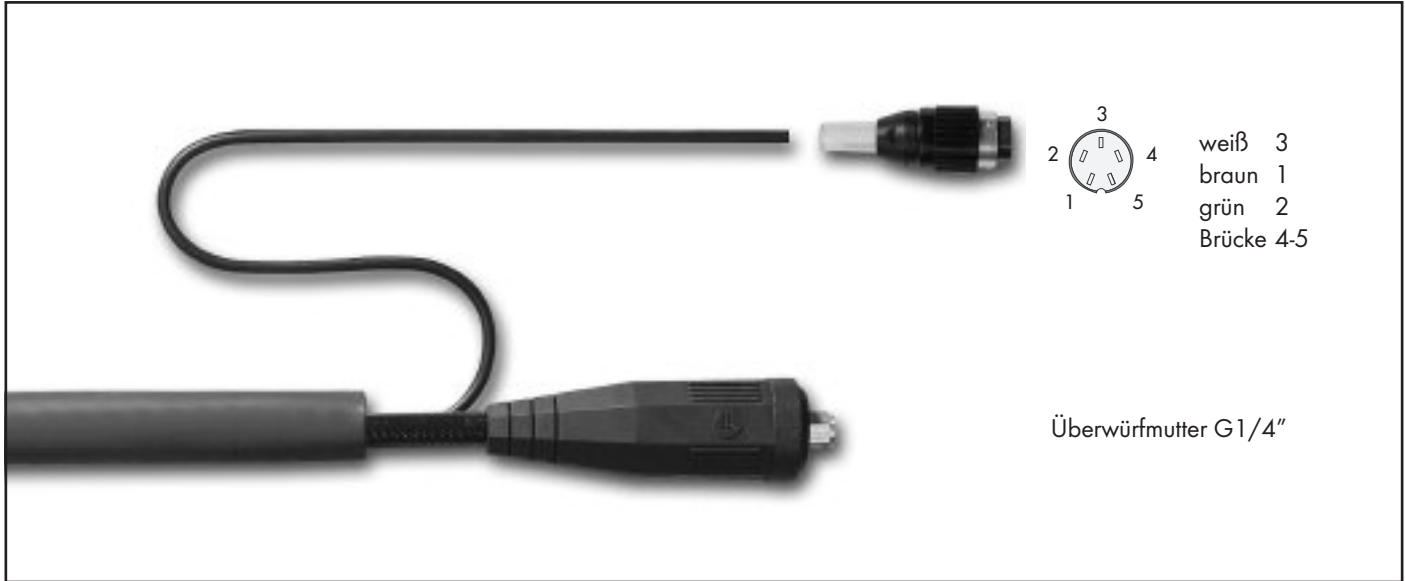

Brennertyp	Länge	Schalterfunktion	maschinenseitiger Anschluss	Schlauchpaketausführung	Bestellnummer
ABITIG® 9	4 m	DD	EA Tuchel 5-pol.	Standard	7S1SK043101102D00
	8 m	DD	EA Tuchel 5-pol.	Standard	7S1SK083101102D00
	4 m	DD	EA Tuchel 5-pol.	High Flex Leder	7S1SH043101102D00
	8 m	DD	EA Tuchel 5-pol.	High Flex Leder	7S1SH083101102D00
ABITIG® 9F	4 m	DD	EA Tuchel 5-pol.	Standard	7S1FK043101102D00
	8 m	DD	EA Tuchel 5-pol.	Standard	7S1FK083101102D00
	4 m	DD	EA Tuchel 5-pol.	High Flex Leder	7S1FH043101102D00
	8 m	DD	EA Tuchel 5-pol.	High Flex Leder	7S1FH083101102D00
ABITIG® 17	4 m	DD	EA Tuchel 5-pol.	Standard	7S2SK043101102D00
	8 m	DD	EA Tuchel 5-pol.	Standard	7S2SK083101102D00
	4 m	DD	EA Tuchel 5-pol.	High Flex Leder	7S2SH043101102D00
	8 m	DD	EA Tuchel 5-pol.	High Flex Leder	7S2SH083101102D00
ABITIG® 17F	4 m	DD	EA Tuchel 5-pol.	Standard	7S2FK043101102D00
	8 m	DD	EA Tuchel 5-pol.	Standard	7S2FK083101102D00
	4 m	DD	EA Tuchel 5-pol.	High Flex Leder	7S2FH043101102D00
	8 m	DD	EA Tuchel 5-pol.	High Flex Leder	7S2FH083101102D00

Technische Änderungen vorbehalten • Verkaufspreise = unverbindliche Preisempfehlung - Angebot freibleibend • © Copyright

ABITIG®-Brennerpreisliste

passend für WIG-Stromquellen des Fabrikates „messer-lincoln“

Brennertyp	Länge	Schalterfunktion	maschinenseitiger Anschluss	Schlauchpaketausführung	Bestellnummer
ABITIG® 26					
ABITIG® 26F					
ABITIG® 24G					
4 m	DD	EA Tuchel 5-pol.	Standard	7S8SK043101102D00	
8 m	DD	EA Tuchel 5-pol.	Standard	7S8SK083101102D00	
4 m	DD	EA Tuchel 5-pol.	High Flex Leder	7S8SH043101102D00	
8 m	DD	EA Tuchel 5-pol.	High Flex Leder	7S8SH083101102D00	
ABITIG® 200					
ABITIG® 200F					
ABITIG® 150					
4 m	DD	EA Tuchel 5-pol.	Standard	7T6SK043101102D00	
8 m	DD	EA Tuchel 5-pol.	Standard	7T6SK083101102D00	
4 m	DD	EA Tuchel 5-pol.	High Flex Leder	7T6SH043101102D00	
8 m	DD	EA Tuchel 5-pol.	High Flex Leder	7T6SH083101102D00	
ABITIG® 150F					
4 m	DD	EA Tuchel 5-pol.	Standard	7T6FK043101102D00	
8 m	DD	EA Tuchel 5-pol.	Standard	7T6FK083101102D00	
4 m	DD	EA Tuchel 5-pol.	High Flex Leder	7T6FH043101102D00	
8 m	DD	EA Tuchel 5-pol.	High Flex Leder	7T6FH083101102D00	

ABITIG®-Brennerpreisliste

passend für WIG-Stromquellen des Fabrikates „messer-lincoln“

Für dieses Gerätefabrikat ist in der Bestellnummer und somit auch im Lieferumfang das Ansteuermodul BIS-10 enthalten. Das Ansteuermodul BIS-10 enthält im Gegensatz zu BIS-02 die verstärkte Schalterausführung (2x) wegen der geräteabhängigen höheren Schaltströme.



Brennertyp	Länge	Schalterfunktion	maschinenseitiger Anschluss	Schlauchpaketausführung	Bestellnummer
ABITIG® 9					
ABITIG® 9F					
ABITIG® 17					
ABITIG® 17F					

Technische Änderungen vorbehalten • Verkaufspreise = unverbindliche Preisempfehlung - Angebot freibleibend • © Copyright

ABITIG®-Brennerpreisliste

passend für WIG-Stromquellen des Fabrikates „messer-lincoln“

Brennertyp	Länge	Schalterfunktion	maschinenseitiger Anschluss	Schlauchpaketausführung	Bestellnummer
ABITIG® 26	4 m	DD	BSB 35-50 Tuchel 5-pol.	Standard	7S3SK043100002D01
	8 m	DD	BSB 35-50 Tuchel 5-pol.	Standard	7S3SK083100002D01
	4 m	DD	BSB 35-50 Tuchel 5-pol.	High Flex Leder	7S3SH043100002D01
	8 m	DD	BSB 35-50 Tuchel 5-pol.	High Flex Leder	7S3SH083100002D01
ABITIG® 26F	4 m	DD	BSB 35-50 Tuchel 5-pol.	Standard	7S3FK043100002D01
	8 m	DD	BSB 35-50 Tuchel 5-pol.	Standard	7S3FK083100002D01
	4 m	DD	BSB 35-50 Tuchel 5-pol.	High Flex Leder	7S3FH043100002D01
	8 m	DD	BSB 35-50 Tuchel 5-pol.	High Flex Leder	7S3FH083100002D01
ABITIG® 24G	4 m	DD	BSB 35-50 Tuchel 5-pol.	Standard	7S8SK043100002D01
	8 m	DD	BSB 35-50 Tuchel 5-pol.	Standard	7S8SK083100002D01
	4 m	DD	BSB 35-50 Tuchel 5-pol.	High Flex Leder	7S8SH043100002D01
	8 m	DD	BSB 35-50 Tuchel 5-pol.	High Flex Leder	7S8SH083100002D01
ABITIG® 200	4 m	DD	BSB 35-50 Tuchel 5-pol.	Standard	7T4SK043100002D01
	8 m	DD	BSB 35-50 Tuchel 5-pol.	Standard	7T4SK083100002D01
	4 m	DD	BSB 35-50 Tuchel 5-pol.	High Flex Leder	7T4SH043100002D01
	8 m	DD	BSB 35-50 Tuchel 5-pol.	High Flex Leder	7T4SH083100002D01
ABITIG® 200F	4 m	DD	BSB 35-50 Tuchel 5-pol.	Standard	7T4FK043100002D01
	8 m	DD	BSB 35-50 Tuchel 5-pol.	Standard	7T4FK083100002D01
	4 m	DD	BSB 35-50 Tuchel 5-pol.	High Flex Leder	7T4FH043100002D01
	8 m	DD	BSB 35-50 Tuchel 5-pol.	High Flex Leder	7T4FH083100002D01
ABITIG® 150	4 m	DD	BSB 35-50 Tuchel 5-pol.	Standard	7T6SK043100002D01
	8 m	DD	BSB 35-50 Tuchel 5-pol.	Standard	7T6SK083100002D01
	4 m	DD	BSB 35-50 Tuchel 5-pol.	High Flex Leder	7T6SH043100002D01
	8 m	DD	BSB 35-50 Tuchel 5-pol.	High Flex Leder	7T6SH083100002D01
ABITIG® 150F	4 m	DD	BSB 35-50 Tuchel 5-pol.	Standard	7T6FK043100002D01
	8 m	DD	BSB 35-50 Tuchel 5-pol.	Standard	7T6FK083100002D01
	4 m	DD	BSB 35-50 Tuchel 5-pol.	High Flex Leder	7T6FH043100002D01
	8 m	DD	BSB 35-50 Tuchel 5-pol.	High Flex Leder	7T6FH083100002D01

ABITIG®-Brennerpreisliste

passend für WIG-Stromquellen des Fabrikates „messer-lincoln“

Für dieses Gerätefabrikat ist in der Bestellnummer und somit auch im Lieferumfang das Ansteuermodul BIS-10 enthalten. Das Ansteuermodul BIS-10 enthält im Gegensatz zu BIS-02 die verstärkte Schalterausführung (2x) wegen der geräteabhängigen höheren Schaltströme.



Brennertyp	Länge	Schalterfunktion	maschinenseitiger Anschluss	Schlauchpaketausführung	Bestellnummer
ABITIG® 18	4 m	DD	EA Tuchel 5-pol.	Standard	7S4SK043100801D15
	8 m	DD	EA Tuchel 5-pol.	Standard	7S4SK083100801D15
	4 m	DD	EA Tuchel 5-pol.	High Flex Leder	7S4SH043100801D15
	8 m	DD	EA Tuchel 5-pol.	High Flex Leder	7S4SH083100801D15
ABITIG® 18F	4 m	DD	EA Tuchel 5-pol.	Standard	7S4FK043100801D15
	8 m	DD	EA Tuchel 5-pol.	Standard	7S4FK083100801D15
	4 m	DD	EA Tuchel 5-pol.	High Flex Leder	7S4FH043100801D15
	8 m	DD	EA Tuchel 5-pol.	High Flex Leder	7S4FH083100801D15
ABITIG® 20	4 m	DD	EA Tuchel 5-pol.	Standard	7S5SK043100801D15
	8 m	DD	EA Tuchel 5-pol.	Standard	7S5SK083100801D15
	4 m	DD	EA Tuchel 5-pol.	High Flex Leder	7S5SH043100801D15
	8 m	DD	EA Tuchel 5-pol.	High Flex Leder	7S5SH083100801D15
ABITIG® 20F	4 m	DD	EA Tuchel 5-pol.	Standard	7S5FK043100801D15
	8 m	DD	EA Tuchel 5-pol.	Standard	7S5FK083100801D15
	4 m	DD	EA Tuchel 5-pol.	High Flex Leder	7S5FH043100801D15
	8 m	DD	EA Tuchel 5-pol.	High Flex Leder	7S5FH083100801D15

Technische Änderungen vorbehalten • Verkaufspreise = unverbindliche Preisempfehlung - Angebot freibleibend • © Copyright

ABITIG®-Brennerpreisliste

passend für WIG-Stromquellen des Fabrikates „messer-lincoln“

Brennertyp	Länge	Schalterfunktion	maschinenseitiger Anschluss	Schlauchpaketausführung	Bestellnummer
ABITIG® 12-1	4 m	DD	EA Tuchel 5-pol.	Standard	7S6SK043100801D15
	8 m	DD	EA Tuchel 5-pol.	Standard	7S6SK083100801D15
	4 m	DD	EA Tuchel 5-pol.	High Flex Leder	7S6SH043100801D15
	8 m	DD	EA Tuchel 5-pol.	High Flex Leder	7S6SH083100801D15
<hr/>					
ABITIG® 18SC	4 m	DD	EA Tuchel 5-pol.	Standard	7S7SK043100801D15
	8 m	DD	EA Tuchel 5-pol.	Standard	7S7SK083100801D15
	4 m	DD	EA Tuchel 5-pol.	High Flex Leder	7S7SH043100801D15
	8 m	DD	EA Tuchel 5-pol.	High Flex Leder	7S7SH083100801D15
<hr/>					
ABITIG® 24W	4 m	DD	EA Tuchel 5-pol.	Standard	7S9SK043100801D15
	8 m	DD	EA Tuchel 5-pol.	Standard	7S9SK083100801D15
	4 m	DD	EA Tuchel 5-pol.	High Flex Leder	7S9SH043100801D15
	8 m	DD	EA Tuchel 5-pol.	High Flex Leder	7S9SH083100801D15
<hr/>					
ABITIG® 450W	4 m	DD	EA Tuchel 5-pol.	Standard	7T5SK043100801D15
	8 m	DD	EA Tuchel 5-pol.	Standard	7T5SK083100801D15
	4 m	DD	EA Tuchel 5-pol.	High Flex Leder	7T5SH043100801D15
	8 m	DD	EA Tuchel 5-pol.	High Flex Leder	7T5SH083100801D15
<hr/>					
ABITIG® 260W	4 m	DD	EA Tuchel 5-pol.	Standard	7T7SK043100801D15
	8 m	DD	EA Tuchel 5-pol.	Standard	7T7SK083100801D15
	4 m	DD	EA Tuchel 5-pol.	High Flex Leder	7T7SH043100801D15
	8 m	DD	EA Tuchel 5-pol.	High Flex Leder	7T7SH083100801D15
<hr/>					
ABITIG® 450W SC	4 m	DD	EA Tuchel 5-pol.	Standard	
	8 m	DD	EA Tuchel 5-pol.	Standard	
	4 m	DD	EA Tuchel 5-pol.	High Flex Leder	7T8SH043100801D15
	8 m	DD	EA Tuchel 5-pol.	High Flex Leder	7T8SH083100801D15

ABITIG®-Brennerpreisliste

passend für WIG-Stromquellen des Fabrikates „migatronic“



Brennertyp	Länge	Schalterfunktion	maschinenseitiger Anschluss	Schlauchpaketausführung	Bestellnummer
ABITIG® 9	4 m	EDP	BSB 35-50 Rundsteckverbinder 7-pol.	Standard	7S1SK043090025B04
	8 m	EDP	BSB 35-50 Rundsteckverbinder 7-pol.	Standard	7S1SK083090025B04
	4 m	EDP	BSB 35-50 Rundsteckverbinder 7-pol.	High Flex Leder	7S1SH043090025B04
	8 m	EDP	BSB 35-50 Rundsteckverbinder 7-pol.	High Flex Leder	7S1SH083090025B04

ABITIG® 9F	4 m	EDP	BSB 35-50 Rundsteckverbinder 7-pol.	Standard	7S1FK043090025B04
	8 m	EDP	BSB 35-50 Rundsteckverbinder 7-pol.	Standard	7S1FK083090025B04
	4 m	EDP	BSB 35-50 Rundsteckverbinder 7-pol.	High Flex Leder	7S1FH043090025B04
	8 m	EDP	BSB 35-50 Rundsteckverbinder 7-pol.	High Flex Leder	7S1FH083090025B04

ABITIG® 17	4 m	EDP	BSB 35-50 Rundsteckverbinder 7-pol.	Standard	7S2SK043090025B04
	8 m	EDP	BSB 35-50 Rundsteckverbinder 7-pol.	Standard	7S2SK083090025B04
	4 m	EDP	BSB 35-50 Rundsteckverbinder 7-pol.	High Flex Leder	7S2SH043090025B04
	8 m	EDP	BSB 35-50 Rundsteckverbinder 7-pol.	High Flex Leder	7S2SH083090025B04

ABITIG® 17F	4 m	EDP	BSB 35-50 Rundsteckverbinder 7-pol.	Standard	7S2FK043090025B04
	8 m	EDP	BSB 35-50 Rundsteckverbinder 7-pol.	Standard	7S2FK083090025B04
	4 m	EDP	BSB 35-50 Rundsteckverbinder 7-pol.	High Flex Leder	7S2FH043090025B04
	8 m	EDP	BSB 35-50 Rundsteckverbinder 7-pol.	High Flex Leder	7S2FH083090025B04

Technische Änderungen vorbehalten • Verkaufspreise = unverbindliche Preisempfehlung - Angebot freibleibend • © Copyright

ABITIG®-Brennerpreisliste

passend für WIG-Stromquellen des Fabrikates „migatronic“

Brennertyp	Länge	Schalterfunktion	maschinenseitiger Anschluss	Schlauchpaketausführung	Bestellnummer
ABITIG® 26	4 m	EDP	BSB 35-50 Rundsteckverbinder 7-pol.	Standard	7S3SK043090025B04
	8 m	EDP	BSB 35-50 Rundsteckverbinder 7-pol.	Standard	7S3SK083090025B04
	4 m	EDP	BSB 35-50 Rundsteckverbinder 7-pol.	High Flex Leder	7S3SH043090025B04
	8 m	EDP	BSB 35-50 Rundsteckverbinder 7-pol.	High Flex Leder	7S3SH083090025B04
ABITIG® 26F	4 m	EDP	BSB 35-50 Rundsteckverbinder 7-pol.	Standard	7S3FK043090025B04
	8 m	EDP	BSB 35-50 Rundsteckverbinder 7-pol.	Standard	7S3FK083090025B04
	4 m	EDP	BSB 35-50 Rundsteckverbinder 7-pol.	High Flex Leder	7S3FH043090025B04
	8 m	EDP	BSB 35-50 Rundsteckverbinder 7-pol.	High Flex Leder	7S3FH083090025B04
ABITIG® 24G	4 m	EDP	BSB 35-50 Rundsteckverbinder 7-pol.	Standard	7S8SK043090025B04
	8 m	EDP	BSB 35-50 Rundsteckverbinder 7-pol.	Standard	7S8SK083090025B04
	4 m	EDP	BSB 35-50 Rundsteckverbinder 7-pol.	High Flex Leder	7S8SH043090025B04
	8 m	EDP	BSB 35-50 Rundsteckverbinder 7-pol.	High Flex Leder	7S8SH083090025B04
ABITIG® 200	4 m	EDP	BSB 35-50 Rundsteckverbinder 7-pol.	Standard	7T4SK043090025B04
	8 m	EDP	BSB 35-50 Rundsteckverbinder 7-pol.	Standard	7T4SK083090025B04
	4 m	EDP	BSB 35-50 Rundsteckverbinder 7-pol.	High Flex Leder	7T4SH043090025B04
	8 m	EDP	BSB 35-50 Rundsteckverbinder 7-pol.	High Flex Leder	7T4SH083090025B04
ABITIG® 200F	4 m	EDP	BSB 35-50 Rundsteckverbinder 7-pol.	Standard	7T4FK043090025B04
	8 m	EDP	BSB 35-50 Rundsteckverbinder 7-pol.	Standard	7T4FK083090025B04
	4 m	EDP	BSB 35-50 Rundsteckverbinder 7-pol.	High Flex Leder	7T4FH043090025B04
	8 m	EDP	BSB 35-50 Rundsteckverbinder 7-pol.	High Flex Leder	7T4FH083090025B04
ABITIG® 150	4 m	EDP	BSB 35-50 Rundsteckverbinder 7-pol.	Standard	7T6SK043090025B04
	8 m	EDP	BSB 35-50 Rundsteckverbinder 7-pol.	Standard	7T6SK083090025B04
	4 m	EDP	BSB 35-50 Rundsteckverbinder 7-pol.	High Flex Leder	7T6SH043090025B04
	8 m	EDP	BSB 35-50 Rundsteckverbinder 7-pol.	High Flex Leder	7T6SH083090025B04
ABITIG® 150F	4 m	EDP	BSB 35-50 Rundsteckverbinder 7-pol.	Standard	7T6FK043090025B04
	8 m	EDP	BSB 35-50 Rundsteckverbinder 7-pol.	Standard	7T6FK083090025B04
	4 m	EDP	BSB 35-50 Rundsteckverbinder 7-pol.	High Flex Leder	7T6FH043090025B04
	8 m	EDP	BSB 35-50 Rundsteckverbinder 7-pol.	High Flex Leder	7T6FH083090025B04

ABITIG®-Brennerpreisliste

passend für WIG-Stromquellen des Fabrikates „migatronic“

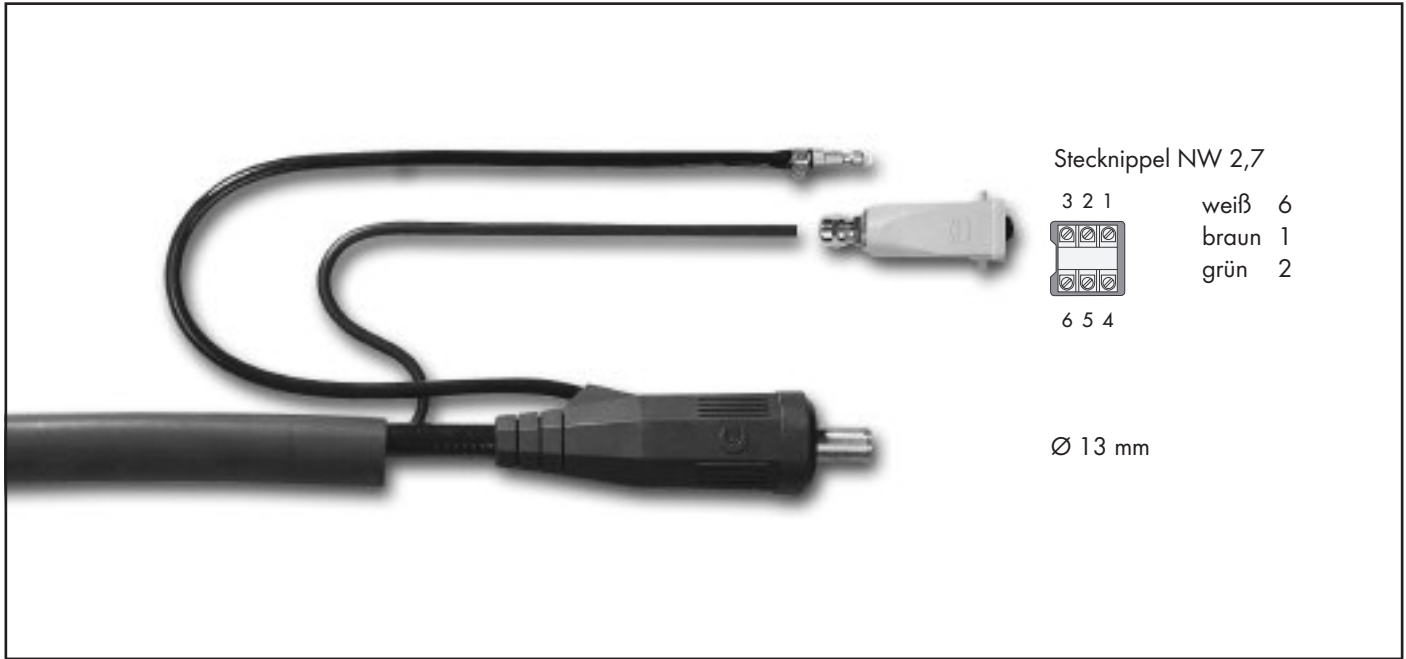

Brennertyp	Länge	Schalterfunktion	maschinenseitiger Anschluss	Schlauchpaketausführung	Bestellnummer
ABITIG® 9	4 m	EDP	BSB 35-50 Harting 6-pol.	Standard	7S1SK043090011B04
	8 m	EDP	BSB 35-50 Harting 6-pol.	Standard	7S1SK083090011B04
	4 m	EDP	BSB 35-50 Harting 6-pol.	High Flex Leder	7S1SH043090011B04
	8 m	EDP	BSB 35-50 Harting 6-pol.	High Flex Leder	7S1SH083090011B04
ABITIG® 9F	4 m	EDP	BSB 35-50 Harting 6-pol.	Standard	7S1FK043090011B04
	8 m	EDP	BSB 35-50 Harting 6-pol.	Standard	7S1FK083090011B04
	4 m	EDP	BSB 35-50 Harting 6-pol.	High Flex Leder	7S1FH043090011B04
	8 m	EDP	BSB 35-50 Harting 6-pol.	High Flex Leder	7S1FH083090011B04
ABITIG® 17	4 m	EDP	BSB 35-50 Harting 6-pol.	Standard	7S2SK043090011B04
	8 m	EDP	BSB 35-50 Harting 6-pol.	Standard	7S2SK083090011B04
	4 m	EDP	BSB 35-50 Harting 6-pol.	High Flex Leder	7S2SH043090011B04
	8 m	EDP	BSB 35-50 Harting 6-pol.	High Flex Leder	7S2SH083090011B04
ABITIG® 17F	4 m	EDP	BSB 35-50 Harting 6-pol.	Standard	7S2FK043090011B04
	8 m	EDP	BSB 35-50 Harting 6-pol.	Standard	7S2FK083090011B04
	4 m	EDP	BSB 35-50 Harting 6-pol.	High Flex Leder	7S2FH043090011B04
	8 m	EDP	BSB 35-50 Harting 6-pol.	High Flex Leder	7S2FH083090011B04

Technische Änderungen vorbehalten • Verkaufspreise = unverbindliche Preisempfehlung - Angebot freibleibend • © Copyright

ABITIG®-Brennerpreisliste

passend für WIG-Stromquellen des Fabrikates „migatronic“

Brennertyp	Länge	Schalterfunktion	maschinenseitiger Anschluss	Schlauchpaketausführung	Bestellnummer
ABITIG® 26	4 m	EDP	BSB 35-50 Harting 6-pol.	Standard	7S3SK04309001 1B04
	8 m	EDP	BSB 35-50 Harting 6-pol.	Standard	7S3SK08309001 1B04
	4 m	EDP	BSB 35-50 Harting 6-pol.	High Flex Leder	7S3SH04309001 1B04
	8 m	EDP	BSB 35-50 Harting 6-pol.	High Flex Leder	7S3SH08309001 1B04

ABITIG® 26F	4 m	EDP	BSB 35-50 Harting 6-pol.	Standard	7S3FK04309001 1B04
	8 m	EDP	BSB 35-50 Harting 6-pol.	Standard	7S3FK08309001 1B04
	4 m	EDP	BSB 35-50 Harting 6-pol.	High Flex Leder	7S3FH04309001 1B04
	8 m	EDP	BSB 35-50 Harting 6-pol.	High Flex Leder	7S3FH08309001 1B04

ABITIG® 24G	4 m	EDP	BSB 35-50 Harting 6-pol.	Standard	7S8SK04309001 1B04
	8 m	EDP	BSB 35-50 Harting 6-pol.	Standard	7S8SK08309001 1B04
	4 m	EDP	BSB 35-50 Harting 6-pol.	High Flex Leder	7S8SH04309001 1B04
	8 m	EDP	BSB 35-50 Harting 6-pol.	High Flex Leder	7S8SH08309001 1B04

ABITIG® 200	4 m	EDP	BSB 35-50 Harting 6-pol.	Standard	7T4SK04309001 1B04
	8 m	EDP	BSB 35-50 Harting 6-pol.	Standard	7T4SK08309001 1B04
	4 m	EDP	BSB 35-50 Harting 6-pol.	High Flex Leder	7T4SH04309001 1B04
	8 m	EDP	BSB 35-50 Harting 6-pol.	High Flex Leder	7T4SH08309001 1B04

ABITIG® 200F	4 m	EDP	BSB 35-50 Harting 6-pol.	Standard	7T4FK04309001 1B04
	8 m	EDP	BSB 35-50 Harting 6-pol.	Standard	7T4FK08309001 1B04
	4 m	EDP	BSB 35-50 Harting 6-pol.	High Flex Leder	7T4FH04309001 1B04
	8 m	EDP	BSB 35-50 Harting 6-pol.	High Flex Leder	7T4FH08309001 1B04

ABITIG® 150	4 m	EDP	BSB 35-50 Harting 6-pol.	Standard	7T6SK04309001 1B04
	8 m	EDP	BSB 35-50 Harting 6-pol.	Standard	7T6SK08309001 1B04
	4 m	EDP	BSB 35-50 Harting 6-pol.	High Flex Leder	7T6SH04309001 1B04
	8 m	EDP	BSB 35-50 Harting 6-pol.	High Flex Leder	7T6SH08309001 1B04

ABITIG® 150F	4 m	EDP	BSB 35-50 Harting 6-pol.	Standard	7T6FK04309001 1B04
	8 m	EDP	BSB 35-50 Harting 6-pol.	Standard	7T6FK08309001 1B04
	4 m	EDP	BSB 35-50 Harting 6-pol.	High Flex Leder	7T6FH04309001 1B04
	8 m	EDP	BSB 35-50 Harting 6-pol.	High Flex Leder	7T6FH08309001 1B04

ABITIG®-Brennerpreisliste

passend für WIG-Stromquellen des Fabrikates „migatronic“



Brennertyp	Länge	Schalterfunktion	maschinenseitiger Anschluss	Schlauchpaketausführung	Bestellnummer
ABITIG® 9	4 m	ED	BSB 35-50 Rundsteckverbinder 7-pol.	Standard	7S1SK043010025A04
	8 m	ED	BSB 35-50 Rundsteckverbinder 7-pol.	Standard	7S1SK083010025A04
	4 m	ED	BSB 35-50 Rundsteckverbinder 7-pol.	High Flex Leder	7S1SH043010025A04
	8 m	ED	BSB 35-50 Rundsteckverbinder 7-pol.	High Flex Leder	7S1SH083010025A04
ABITIG® 9F	4 m	ED	BSB 35-50 Rundsteckverbinder 7-pol.	Standard	7S1FK043010025A04
	8 m	ED	BSB 35-50 Rundsteckverbinder 7-pol.	Standard	7S1FK083010025A04
	4 m	ED	BSB 35-50 Rundsteckverbinder 7-pol.	High Flex Leder	7S1FH043010025A04
	8 m	ED	BSB 35-50 Rundsteckverbinder 7-pol.	High Flex Leder	7S1FH083010025A04
ABITIG® 17	4 m	ED	BSB 35-50 Rundsteckverbinder 7-pol.	Standard	7S2SK043010025A04
	8 m	ED	BSB 35-50 Rundsteckverbinder 7-pol.	Standard	7S2SK083010025A04
	4 m	ED	BSB 35-50 Rundsteckverbinder 7-pol.	High Flex Leder	7S2SH043010025A04
	8 m	ED	BSB 35-50 Rundsteckverbinder 7-pol.	High Flex Leder	7S2SH083010025A04
ABITIG® 17F	4 m	ED	BSB 35-50 Rundsteckverbinder 7-pol.	Standard	7S2FK043010025A04
	8 m	ED	BSB 35-50 Rundsteckverbinder 7-pol.	Standard	7S2FK083010025A04
	4 m	ED	BSB 35-50 Rundsteckverbinder 7-pol.	High Flex Leder	7S2FH043010025A04
	8 m	ED	BSB 35-50 Rundsteckverbinder 7-pol.	High Flex Leder	7S2FH083010025A04

Technische Änderungen vorbehalten • Verkaufspreise = unverbindliche Preisempfehlung - Angebot freibleibend • © Copyright

ABITIG®-Brennerpreisliste

passend für WIG-Stromquellen des Fabrikates „migatronic“

Brennertyp	Länge	Schalterfunktion	maschinenseitiger Anschluss	Schlauchpaketausführung	Bestellnummer
ABITIG® 26	4 m	ED	BSB 35-50 Rundsteckverbinder 7-pol.	Standard	7S3SK043010025A04
	8 m	ED	BSB 35-50 Rundsteckverbinder 7-pol.	Standard	7S3SK083010025A04
	4 m	ED	BSB 35-50 Rundsteckverbinder 7-pol.	High Flex Leder	7S3SH043010025A04
	8 m	ED	BSB 35-50 Rundsteckverbinder 7-pol.	High Flex Leder	7S3SH083010025A04
ABITIG® 26F	4 m	ED	BSB 35-50 Rundsteckverbinder 7-pol.	Standard	7S3FK043010025A04
	8 m	ED	BSB 35-50 Rundsteckverbinder 7-pol.	Standard	7S3FK083010025A04
	4 m	ED	BSB 35-50 Rundsteckverbinder 7-pol.	High Flex Leder	7S3FH043010025A04
	8 m	ED	BSB 35-50 Rundsteckverbinder 7-pol.	High Flex Leder	7S3FH083010025A04
ABITIG® 24G	4 m	ED	BSB 35-50 Rundsteckverbinder 7-pol.	Standard	7S8SK043010025A04
	8 m	ED	BSB 35-50 Rundsteckverbinder 7-pol.	Standard	7S8SK083010025A04
	4 m	ED	BSB 35-50 Rundsteckverbinder 7-pol.	High Flex Leder	7S8SH043010025A04
	8 m	ED	BSB 35-50 Rundsteckverbinder 7-pol.	High Flex Leder	7S8SH083010025A04
ABITIG® 200	4 m	ED	BSB 35-50 Rundsteckverbinder 7-pol.	Standard	7T4SK043010025A04
	8 m	ED	BSB 35-50 Rundsteckverbinder 7-pol.	Standard	7T4SK083010025A04
	4 m	ED	BSB 35-50 Rundsteckverbinder 7-pol.	High Flex Leder	7T4SH043010025A04
	8 m	ED	BSB 35-50 Rundsteckverbinder 7-pol.	High Flex Leder	7T4SH083010025A04
ABITIG® 200F	4 m	ED	BSB 35-50 Rundsteckverbinder 7-pol.	Standard	7T4FK043010025A04
	8 m	ED	BSB 35-50 Rundsteckverbinder 7-pol.	Standard	7T4FK083010025A04
	4 m	ED	BSB 35-50 Rundsteckverbinder 7-pol.	High Flex Leder	7T4FH043010025A04
	8 m	ED	BSB 35-50 Rundsteckverbinder 7-pol.	High Flex Leder	7T4FH083010025A04
ABITIG® 150	4 m	ED	BSB 35-50 Rundsteckverbinder 7-pol.	Standard	7T6SK043010025A04
	8 m	ED	BSB 35-50 Rundsteckverbinder 7-pol.	Standard	7T6SK083010025A04
	4 m	ED	BSB 35-50 Rundsteckverbinder 7-pol.	High Flex Leder	7T6SH043010025A04
	8 m	ED	BSB 35-50 Rundsteckverbinder 7-pol.	High Flex Leder	7T6SH083010025A04
ABITIG® 150F	4 m	ED	BSB 35-50 Rundsteckverbinder 7-pol.	Standard	7T6FK043010025A04
	8 m	ED	BSB 35-50 Rundsteckverbinder 7-pol.	Standard	7T6FK083010025A04
	4 m	ED	BSB 35-50 Rundsteckverbinder 7-pol.	High Flex Leder	7T6FH043010025A04
	8 m	ED	BSB 35-50 Rundsteckverbinder 7-pol.	High Flex Leder	7T6FH083010025A04

ABITIG®-Brennerpreisliste

passend für WIG-Stromquellen des Fabrikates „migatronic“

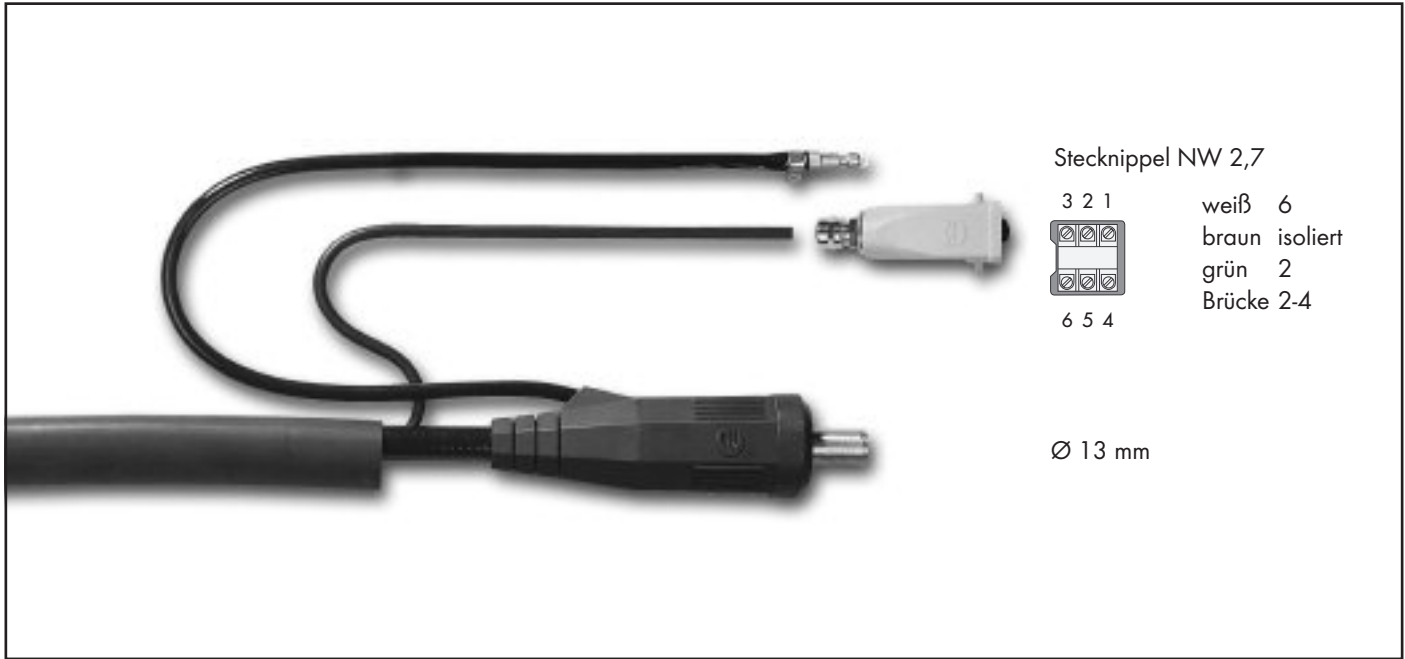

Brennertyp	Länge	Schalterfunktion	maschinenseitiger Anschluss	Schlauchpaketausführung	Bestellnummer
ABITIG® 9	4 m	ED	BSB 35-50 Harting 6-pol.	Standard	7S1SK043010011A04
	8 m	ED	BSB 35-50 Harting 6-pol.	Standard	7S1SK083010011A04
	4 m	ED	BSB 35-50 Harting 6-pol.	High Flex Leder	7S1SH043010011A04
	8 m	ED	BSB 35-50 Harting 6-pol.	High Flex Leder	7S1SH083010011A04
ABITIG® 9F	4 m	ED	BSB 35-50 Harting 6-pol.	Standard	7S1FK043010011A04
	8 m	ED	BSB 35-50 Harting 6-pol.	Standard	7S1FK083010011A04
	4 m	ED	BSB 35-50 Harting 6-pol.	High Flex Leder	7S1FH043010011A04
	8 m	ED	BSB 35-50 Harting 6-pol.	High Flex Leder	7S1FH083010011A04
ABITIG® 17	4 m	ED	BSB 35-50 Harting 6-pol.	Standard	7S2SK043010011A04
	8 m	ED	BSB 35-50 Harting 6-pol.	Standard	7S2SK083010011A04
	4 m	ED	BSB 35-50 Harting 6-pol.	High Flex Leder	7S2SH043010011A04
	8 m	ED	BSB 35-50 Harting 6-pol.	High Flex Leder	7S2SH083010011A04
ABITIG® 17F	4 m	ED	BSB 35-50 Harting 6-pol.	Standard	7S2FK043010011A04
	8 m	ED	BSB 35-50 Harting 6-pol.	Standard	7S2FK083010011A04
	4 m	ED	BSB 35-50 Harting 6-pol.	High Flex Leder	7S2FH043010011A04
	8 m	ED	BSB 35-50 Harting 6-pol.	High Flex Leder	7S2FH083010011A04

Technische Änderungen vorbehalten • Verkaufspreise = unverbindliche Preisempfehlung - Angebot freibleibend • © Copyright

ABITIG®-Brennerpreisliste

passend für WIG-Stromquellen des Fabrikates „migatronic“

Brennertyp	Länge	Schalterfunktion	maschinenseitiger Anschluss	Schlauchpaketausführung	Bestellnummer
ABITIG® 26	4 m	ED	BSB 35-50 Harting 6-pol.	Standard	7S3SK043010011A04
	8 m	ED	BSB 35-50 Harting 6-pol.	Standard	7S3SK083010011A04
	4 m	ED	BSB 35-50 Harting 6-pol.	High Flex Leder	7S3SH043010011A04
	8 m	ED	BSB 35-50 Harting 6-pol.	High Flex Leder	7S3SH083010011A04
ABITIG® 26F	4 m	ED	BSB 35-50 Harting 6-pol.	Standard	7S3FK043010011A04
	8 m	ED	BSB 35-50 Harting 6-pol.	Standard	7S3FK083010011A04
	4 m	ED	BSB 35-50 Harting 6-pol.	High Flex Leder	7S3FH043010011A04
	8 m	ED	BSB 35-50 Harting 6-pol.	High Flex Leder	7S3FH083010011A04
ABITIG® 24G	4 m	ED	BSB 35-50 Harting 6-pol.	Standard	7S8SK043010011A04
	8 m	ED	BSB 35-50 Harting 6-pol.	Standard	7S8SK083010011A04
	4 m	ED	BSB 35-50 Harting 6-pol.	High Flex Leder	7S8SH043010011A04
	8 m	ED	BSB 35-50 Harting 6-pol.	High Flex Leder	7S8SH083010011A04
ABITIG® 200	4 m	ED	BSB 35-50 Harting 6-pol.	Standard	7T4SK043010011A04
	8 m	ED	BSB 35-50 Harting 6-pol.	Standard	7T4SK083010011A04
	4 m	ED	BSB 35-50 Harting 6-pol.	High Flex Leder	7T4SH043010011A04
	8 m	ED	BSB 35-50 Harting 6-pol.	High Flex Leder	7T4SH083010011A04
ABITIG® 200F	4 m	ED	BSB 35-50 Harting 6-pol.	Standard	7T4FK043010011A04
	8 m	ED	BSB 35-50 Harting 6-pol.	Standard	7T4FK083010011A04
	4 m	ED	BSB 35-50 Harting 6-pol.	High Flex Leder	7T4FH043010011A04
	8 m	ED	BSB 35-50 Harting 6-pol.	High Flex Leder	7T4FH083010011A04
ABITIG® 150	4 m	ED	BSB 35-50 Harting 6-pol.	Standard	7T6SK043010011A04
	8 m	ED	BSB 35-50 Harting 6-pol.	Standard	7T6SK083010011A04
	4 m	ED	BSB 35-50 Harting 6-pol.	High Flex Leder	7T6SH043010011A04
	8 m	ED	BSB 35-50 Harting 6-pol.	High Flex Leder	7T6SH083010011A04
ABITIG® 150F	4 m	ED	BSB 35-50 Harting 6-pol.	Standard	7T6FK043010011A04
	8 m	ED	BSB 35-50 Harting 6-pol.	Standard	7T6FK083010011A04
	4 m	ED	BSB 35-50 Harting 6-pol.	High Flex Leder	7T6FH043010011A04
	8 m	ED	BSB 35-50 Harting 6-pol.	High Flex Leder	7T6FH083010011A04

ABITIG®-Brennerpreisliste

passend für WIG-Stromquellen des Fabrikates „migatronic“



Brennertyp	Länge	Schalterfunktion	maschinenseitiger Anschluss	Schlauchpaketausführung	Bestellnummer
ABITIG® 9	4 m	ED	ZA 9-pol.	Standard	7S1SK043010799C00
	8 m	ED	ZA 9-pol.	Standard	7S1SK083010799C00
	4 m	ED	ZA 9-pol.	High Flex Leder	7S1SH043010799C00
	8 m	ED	ZA 9-pol.	High Flex Leder	7S1SH083010799C00

ABITIG® 9F	4 m	ED	ZA 9-pol.	Standard	7S1FK043010799C00
	8 m	ED	ZA 9-pol.	Standard	7S1FK083010799C00
	4 m	ED	ZA 9-pol.	High Flex Leder	7S1FH043010799C00
	8 m	ED	ZA 9-pol.	High Flex Leder	7S1FH083010799C00

ABITIG® 17	4 m	ED	ZA 9-pol.	Standard	7S2SK043010799C00
	8 m	ED	ZA 9-pol.	Standard	7S2SK083010799C00
	4 m	ED	ZA 9-pol.	High Flex Leder	7S2SH043010799C00
	8 m	ED	ZA 9-pol.	High Flex Leder	7S2SH083010799C00

ABITIG® 17F	4 m	ED	ZA 9-pol.	Standard	7S2FK043010799C00
	8 m	ED	ZA 9-pol.	Standard	7S2FK083010799C00
	4 m	ED	ZA 9-pol.	High Flex Leder	7S2FH043010799C00
	8 m	ED	ZA 9-pol.	High Flex Leder	7S2FH083010799C00

Technische Änderungen vorbehalten • Verkaufspreise = unverbindliche Preisempfehlung - Angebot freibleibend • © Copyright

ABITIG®-Brennerpreisliste

passend für WIG-Stromquellen des Fabrikates „migatronik“

Brennertyp	Länge	Schalterfunktion	maschinenseitiger Anschluss	Schlauchpaketausführung	Bestellnummer
ABITIG® 26	4 m	ED	ZA 9-pol.	Standard	7S3SK043010799C00
	8 m	ED	ZA 9-pol.	Standard	7S3SK083010799C00
	4 m	ED	ZA 9-pol.	High Flex Leder	7S3SH043010799C00
	8 m	ED	ZA 9-pol.	High Flex Leder	7S3SH083010799C00
ABITIG® 26F	4 m	ED	ZA 9-pol.	Standard	7S3FK043010799C00
	8 m	ED	ZA 9-pol.	Standard	7S3FK083010799C00
	4 m	ED	ZA 9-pol.	High Flex Leder	7S3FH043010799C00
	8 m	ED	ZA 9-pol.	High Flex Leder	7S3FH083010799C00
ABITIG® 24G	4 m	ED	ZA 9-pol.	Standard	7S8SK043010799C00
	8 m	ED	ZA 9-pol.	Standard	7S8SK083010799C00
	4 m	ED	ZA 9-pol.	High Flex Leder	7S8SH043010799C00
	8 m	ED	ZA 9-pol.	High Flex Leder	7S8SH083010799C00
ABITIG® 200	4 m	ED	ZA 9-pol.	Standard	7T4SK043010799C00
	8 m	ED	ZA 9-pol.	Standard	7T4SK083010799C00
	4 m	ED	ZA 9-pol.	High Flex Leder	7T4SH043010799C00
	8 m	ED	ZA 9-pol.	High Flex Leder	7T4SH083010799C00
ABITIG® 200F	4 m	ED	ZA 9-pol.	Standard	7T4FK043010799C00
	8 m	ED	ZA 9-pol.	Standard	7T4FK083010799C00
	4 m	ED	ZA 9-pol.	High Flex Leder	7T4FH043010799C00
	8 m	ED	ZA 9-pol.	High Flex Leder	7T4FH083010799C00
ABITIG® 150	4 m	ED	ZA 9-pol.	Standard	7T6SK043010799C00
	8 m	ED	ZA 9-pol.	Standard	7T6SK083010799C00
	4 m	ED	ZA 9-pol.	High Flex Leder	7T6SH043010799C00
	8 m	ED	ZA 9-pol.	High Flex Leder	7T6SH083010799C00
ABITIG® 150F	4 m	ED	ZA 9-pol.	Standard	7T6FK043010799C00
	8 m	ED	ZA 9-pol.	Standard	7T6FK083010799C00
	4 m	ED	ZA 9-pol.	High Flex Leder	7T6FH043010799C00
	8 m	ED	ZA 9-pol.	High Flex Leder	7T6FH083010799C00

ABITIG®-Brennerpreisliste

passend für WIG-Stromquellen des Fabrikates „migatronic“



Brennertyp	Länge	Schalterfunktion	maschinenseitiger Anschluss	Schlauchpaketausführung	Bestellnummer
ABITIG® 9	4 m	EDP	ZA 9-pol.	Standard	7S1SK043090799C00
	8 m	EDP	ZA 9-pol.	Standard	7S1SK083090799C00
	4 m	EDP	ZA 9-pol.	High Flex Leder	7S1SH043090799C00
	8 m	EDP	ZA 9-pol.	High Flex Leder	7S1SH083090799C00
ABITIG® 9F	4 m	EDP	ZA 9-pol.	Standard	7S1FK043090799C00
	8 m	EDP	ZA 9-pol.	Standard	7S1FK083090799C00
	4 m	EDP	ZA 9-pol.	High Flex Leder	7S1FH043090799C00
	8 m	EDP	ZA 9-pol.	High Flex Leder	7S1FH083090799C00
ABITIG® 17	4 m	EDP	ZA 9-pol.	Standard	7S2SK043090799C00
	8 m	EDP	ZA 9-pol.	Standard	7S2SK083090799C00
	4 m	EDP	ZA 9-pol.	High Flex Leder	7S2SH043090799C00
	8 m	EDP	ZA 9-pol.	High Flex Leder	7S2SH083010799C00
ABITIG® 17F	4 m	EDP	ZA 9-pol.	Standard	7S2FK043090799C00
	8 m	EDP	ZA 9-pol.	Standard	7S2FK083090799C00
	4 m	EDP	ZA 9-pol.	High Flex Leder	7S2FH043090799C00
	8 m	EDP	ZA 9-pol.	High Flex Leder	7S2FH083090799C00

Technische Änderungen vorbehalten • Verkaufspreise = unverbindliche Preisempfehlung - Angebot freibleibend • © Copyright

ABITIG®-Brennerpreisliste

passend für WIG-Stromquellen des Fabrikates „migatronik“

Brennertyp	Länge	Schalterfunktion	maschinenseitiger Anschluss	Schlauchpaketausführung	Bestellnummer
ABITIG® 26	4 m	EDP	ZA 9-pol.	Standard	7S3SK043090799C00
	8 m	EDP	ZA 9-pol.	Standard	7S3SK083090799C00
	4 m	EDP	ZA 9-pol.	High Flex Leder	7S3SH043090799C00
	8 m	EDP	ZA 9-pol.	High Flex Leder	7S3SH083090799C00
ABITIG® 26F	4 m	EDP	ZA 9-pol.	Standard	7S3FK043090799C00
	8 m	EDP	ZA 9-pol.	Standard	7S3FK083090799C00
	4 m	EDP	ZA 9-pol.	High Flex Leder	7S3FH043090799C00
	8 m	EDP	ZA 9-pol.	High Flex Leder	7S3FH083090799C00
ABITIG® 24G	4 m	EDP	ZA 9-pol.	Standard	7S8SK043090799C00
	8 m	EDP	ZA 9-pol.	Standard	7S8SK083090799C00
	4 m	EDP	ZA 9-pol.	High Flex Leder	7S8SH043090799C00
	8 m	EDP	ZA 9-pol.	High Flex Leder	7S8SH083090799C00
ABITIG® 200	4 m	EDP	ZA 9-pol.	Standard	7T4SK043090799C00
	8 m	EDP	ZA 9-pol.	Standard	7T4SK083090799C00
	4 m	EDP	ZA 9-pol.	High Flex Leder	7T4SH043090799C00
	8 m	EDP	ZA 9-pol.	High Flex Leder	7T4SH083090799C00
ABITIG® 200F	4 m	EDP	ZA 9-pol.	Standard	7T4FK043090799C00
	8 m	EDP	ZA 9-pol.	Standard	7T4FK083090799C00
	4 m	EDP	ZA 9-pol.	High Flex Leder	7T4FH043090799C00
	8 m	EDP	ZA 9-pol.	High Flex Leder	7T4FH083090799C00
ABITIG® 150	4 m	EDP	ZA 9-pol.	Standard	7T6SK043090799C00
	8 m	EDP	ZA 9-pol.	Standard	7T6SK083090799C00
	4 m	EDP	ZA 9-pol.	High Flex Leder	7T6SH043090799C00
	8 m	EDP	ZA 9-pol.	High Flex Leder	7T6SH083090799C00
ABITIG® 150F	4 m	EDP	ZA 9-pol.	Standard	7T6FK043090799C00
	8 m	EDP	ZA 9-pol.	Standard	7T6FK083090799C00
	4 m	EDP	ZA 9-pol.	High Flex Leder	7T6FH043090799C00
	8 m	EDP	ZA 9-pol.	High Flex Leder	7T6FH083090799C00

ABITIG®-Brennerpreisliste

passend für WIG-Stromquellen des Fabrikates „migatronic“

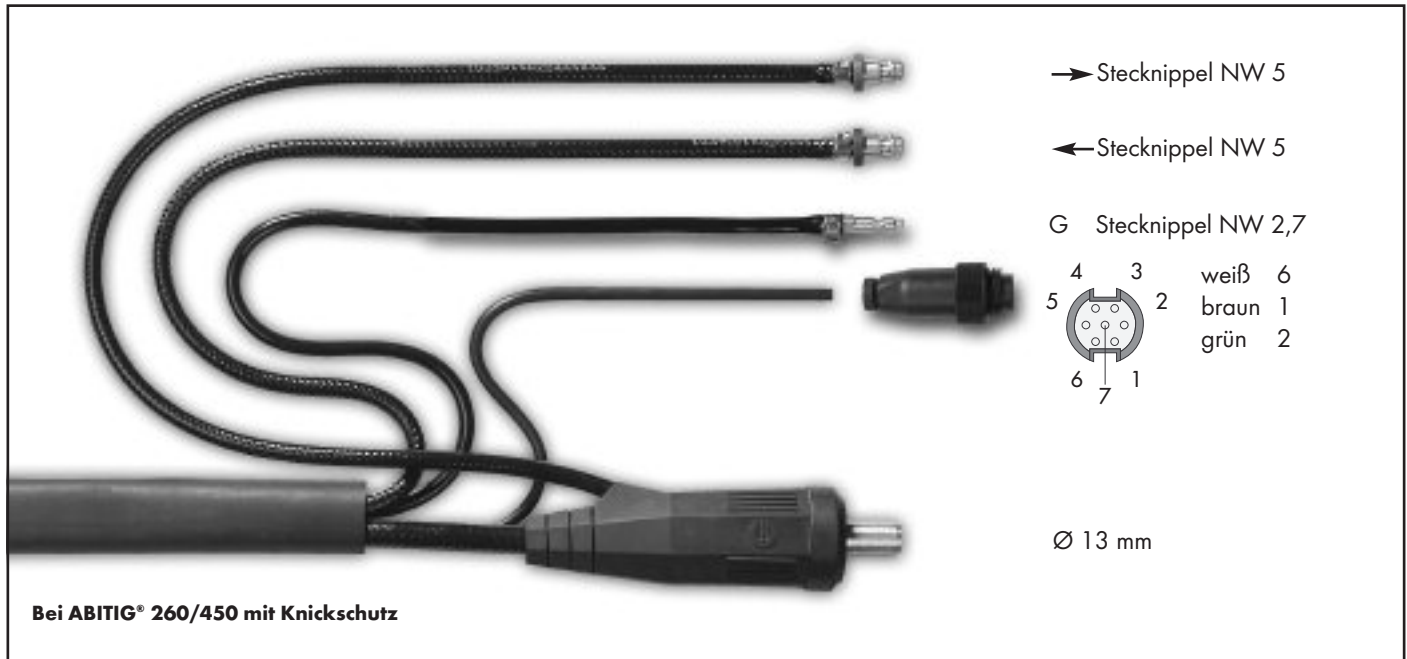

Brennertyp	Länge	Schalterfunktion	maschinenseitiger Anschluss	Schlauchpaketausführung	Bestellnummer
ABITIG® 18	4 m	EDP	BSB 35-50 Rundsteckverbinder 7-pol.	Standard	7S4SK043090025D22
	8 m	EDP	BSB 35-50 Rundsteckverbinder 7-pol.	Standard	7S4SK083090025D22
	4 m	EDP	BSB 35-50 Rundsteckverbinder 7-pol.	High Flex Leder	7S4SH043090025D22
	8 m	EDP	BSB 35-50 Rundsteckverbinder 7-pol.	High Flex Leder	7S4SH083090025D22
ABITIG® 18F	4 m	EDP	BSB 35-50 Rundsteckverbinder 7-pol.	Standard	7S4FK043090025D22
	8 m	EDP	BSB 35-50 Rundsteckverbinder 7-pol.	Standard	7S4FK083090025D22
	4 m	EDP	BSB 35-50 Rundsteckverbinder 7-pol.	High Flex Leder	7S4FH043090025D22
	8 m	EDP	BSB 35-50 Rundsteckverbinder 7-pol.	High Flex Leder	7S4FH083090025D22
ABITIG® 20	4 m	EDP	BSB 35-50 Rundsteckverbinder 7-pol.	Standard	7S5SK043090025D22
	8 m	EDP	BSB 35-50 Rundsteckverbinder 7-pol.	Standard	7S5SK083090025D22
	4 m	EDP	BSB 35-50 Rundsteckverbinder 7-pol.	High Flex Leder	7S5SH043090025D22
	8 m	EDP	BSB 35-50 Rundsteckverbinder 7-pol.	High Flex Leder	7S5SH083090025D22
ABITIG® 20F	4 m	EDP	BSB 35-50 Rundsteckverbinder 7-pol.	Standard	7S5FK043090025D22
	8 m	EDP	BSB 35-50 Rundsteckverbinder 7-pol.	Standard	7S5FK083090025D22
	4 m	EDP	BSB 35-50 Rundsteckverbinder 7-pol.	High Flex Leder	7S5FH043090025D22
	8 m	EDP	BSB 35-50 Rundsteckverbinder 7-pol.	High Flex Leder	7S5FH083090025D22

Technische Änderungen vorbehalten • Verkaufspreise = unverbindliche Preisempfehlung - Angebot freibleibend • © Copyright

ABITIG®-Brennerpreisliste

passend für WIG-Stromquellen des Fabrikates „migatronic“

Brennertyp	Länge	Schalterfunktion	maschinenseitiger Anschluss	Schlauchpaketausführung	Bestellnummer
ABITIG® 12-1	4 m	EDP	BSB 35-50 Rundsteckverbinder 7-pol.	Standard	7S6SK043090025D22
	8 m	EDP	BSB 35-50 Rundsteckverbinder 7-pol.	Standard	7S6SK083090025D22
	4 m	EDP	BSB 35-50 Rundsteckverbinder 7-pol.	High Flex Leder	7S6SH043090025D22
	8 m	EDP	BSB 35-50 Rundsteckverbinder 7-pol.	High Flex Leder	7S6SH083090025D22
ABITIG® 18SC	4 m	EDP	BSB 35-50 Rundsteckverbinder 7-pol.	Standard	7S7SK043090025D22
	8 m	EDP	BSB 35-50 Rundsteckverbinder 7-pol.	Standard	7S7SK083090025D22
	4 m	EDP	BSB 35-50 Rundsteckverbinder 7-pol.	High Flex Leder	7S7SH043090025D22
	8 m	EDP	BSB 35-50 Rundsteckverbinder 7-pol.	High Flex Leder	7S7SH083090025D22
ABITIG® 24W	4 m	EDP	BSB 35-50 Rundsteckverbinder 7-pol.	Standard	7S9SK043090025D22
	8 m	EDP	BSB 35-50 Rundsteckverbinder 7-pol.	Standard	7S9SK083090025D22
	4 m	EDP	BSB 35-50 Rundsteckverbinder 7-pol.	High Flex Leder	7S9SH043090025D22
	8 m	EDP	BSB 35-50 Rundsteckverbinder 7-pol.	High Flex Leder	7S9SH083090025D22
ABITIG® 450W	4 m	EDP	BSB 35-50 Rundsteckverbinder 7-pol.	Standard	7T5SK043090125D22
	8 m	EDP	BSB 35-50 Rundsteckverbinder 7-pol.	Standard	7T5SK083090125D22
	4 m	EDP	BSB 35-50 Rundsteckverbinder 7-pol.	High Flex Leder	7T5SH043090125D22
	8 m	EDP	BSB 35-50 Rundsteckverbinder 7-pol.	High Flex Leder	7T5SH083090125D22
ABITIG® 260W	4 m	EDP	BSB 35-50 Rundsteckverbinder 7-pol.	Standard	7T7SK043090125D22
	8 m	EDP	BSB 35-50 Rundsteckverbinder 7-pol.	Standard	7T7SK083090125D22
	4 m	EDP	BSB 35-50 Rundsteckverbinder 7-pol.	High Flex Leder	7T7SH043090125D22
	8 m	EDP	BSB 35-50 Rundsteckverbinder 7-pol.	High Flex Leder	7T7SH083090125D22
ABITIG® 450W SC	4 m	EDP	BSB 35-50 Rundsteckverbinder 7-pol.	Standard	
	8 m	EDP	BSB 35-50 Rundsteckverbinder 7-pol.	Standard	
	4 m	EDP	BSB 35-50 Rundsteckverbinder 7-pol.	High Flex Leder	7T8SH043090125D22
	8 m	EDP	BSB 35-50 Rundsteckverbinder 7-pol.	High Flex Leder	7T8SH083090125D22

ABITIG®-Brennerpreisliste

passend für WIG-Stromquellen des Fabrikates „migatronic“

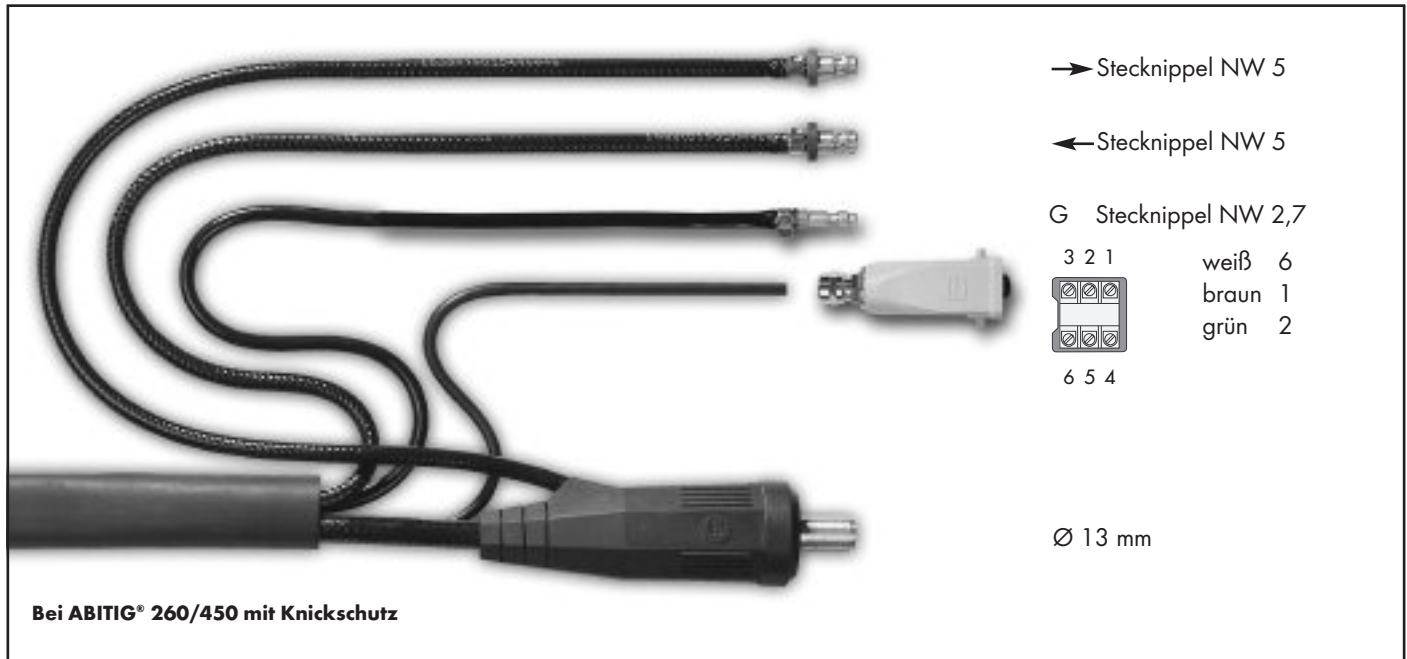

Brennertyp	Länge	Schalterfunktion	maschinenseitiger Anschluss	Schlauchpaketausführung	Bestellnummer
ABITIG® 18	4 m	EDP	BSB 35-50 Harting 6-pol.	Standard	7S4SK043090011D22
	8 m	EDP	BSB 35-50 Harting 6-pol.	Standard	7S4SK083090011D22
	4 m	EDP	BSB 35-50 Harting 6-pol.	High Flex Leder	7S4SH043090011D22
	8 m	EDP	BSB 35-50 Harting 6-pol.	High Flex Leder	7S4SH083090011D22
ABITIG® 18F	4 m	EDP	BSB 35-50 Harting 6-pol.	Standard	7S4FK043090011D22
	8 m	EDP	BSB 35-50 Harting 6-pol.	Standard	7S4FK083090011D22
	4 m	EDP	BSB 35-50 Harting 6-pol.	High Flex Leder	7S4FH043090011D22
	8 m	EDP	BSB 35-50 Harting 6-pol.	High Flex Leder	7S4FH083090011D22
ABITIG® 20	4 m	EDP	BSB 35-50 Harting 6-pol.	Standard	7S5SK043090011D22
	8 m	EDP	BSB 35-50 Harting 6-pol.	Standard	7S5SK083090011D22
	4 m	EDP	BSB 35-50 Harting 6-pol.	High Flex Leder	7S5SH043090011D22
	8 m	EDP	BSB 35-50 Harting 6-pol.	High Flex Leder	7S5SH083090011D22
ABITIG® 20F	4 m	EDP	BSB 35-50 Harting 6-pol.	Standard	7S5FK043090011D22
	8 m	EDP	BSB 35-50 Harting 6-pol.	Standard	7S5FK083090011D22
	4 m	EDP	BSB 35-50 Harting 6-pol.	High Flex Leder	7S5FH043090011D22
	8 m	EDP	BSB 35-50 Harting 6-pol.	High Flex Leder	7S5FH083090011D22

Technische Änderungen vorbehalten • Verkaufspreise = unverbindliche Preisempfehlung - Angebot freibleibend • © Copyright

ABITIG®-Brennerpreisliste

passend für WIG-Stromquellen des Fabrikates „migatronic“

Brennertyp	Länge	Schalterfunktion	maschinenseitiger Anschluss	Schlauchpaketausführung	Bestellnummer
ABITIG® 12-1	4 m	EDP	BSB 35-50 Harting 6-pol.	Standard	7S6SK043090011D22
	8 m	EDP	BSB 35-50 Harting 6-pol.	Standard	7S6SK083090011D22
	4 m	EDP	BSB 35-50 Harting 6-pol.	High Flex Leder	7S6SH043090011D22
	8 m	EDP	BSB 35-50 Harting 6-pol.	High Flex Leder	7S6SH083090011D22

ABITIG® 18SC	4 m	EDP	BSB 35-50 Harting 6-pol.	Standard	7S7SK043090011D22
	8 m	EDP	BSB 35-50 Harting 6-pol.	Standard	7S7SK083090011D22
	4 m	EDP	BSB 35-50 Harting 6-pol.	High Flex Leder	7S7SH043090011D22
	8 m	EDP	BSB 35-50 Harting 6-pol.	High Flex Leder	7S7SH083090011D22

ABITIG® 24W	4 m	EDP	BSB 35-50 Harting 6-pol.	Standard	7S9SK043090011D22
	8 m	EDP	BSB 35-50 Harting 6-pol.	Standard	7S9SK083090011D22
	4 m	EDP	BSB 35-50 Harting 6-pol.	High Flex Leder	7S9SH043090011D22
	8 m	EDP	BSB 35-50 Harting 6-pol.	High Flex Leder	7S9SH083090011D22

ABITIG® 450W	4 m	EDP	BSB 35-50 Harting 6-pol.	Standard	7T5SK043090111D22
	8 m	EDP	BSB 35-50 Harting 6-pol.	Standard	7T5SK083090111D22
	4 m	EDP	BSB 35-50 Harting 6-pol.	High Flex Leder	7T5SH043090111D22
	8 m	EDP	BSB 35-50 Harting 6-pol.	High Flex Leder	7T5SH083090111D22

ABITIG® 260W	4 m	EDP	BSB 35-50 Harting 6-pol.	Standard	7T7SK043090111D22
	8 m	EDP	BSB 35-50 Harting 6-pol.	Standard	7T7SK083090111D22
	4 m	EDP	BSB 35-50 Harting 6-pol.	High Flex Leder	7T7SH043090111D22
	8 m	EDP	BSB 35-50 Harting 6-pol.	High Flex Leder	7T7SH083090111D22

ABITIG® 450W SC	4 m	EDP	BSB 35-50 Harting 6-pol.	Standard	
	8 m	EDP	BSB 35-50 Harting 6-pol.	Standard	
	4 m	EDP	BSB 35-50 Harting 6-pol.	High Flex Leder	7T8SH043090111D22
	8 m	EDP	BSB 35-50 Harting 6-pol.	High Flex Leder	7T8SH083090111D22

ABITIG®-Brennerpreisliste

passend für WIG-Stromquellen des Fabrikates „migatronic“

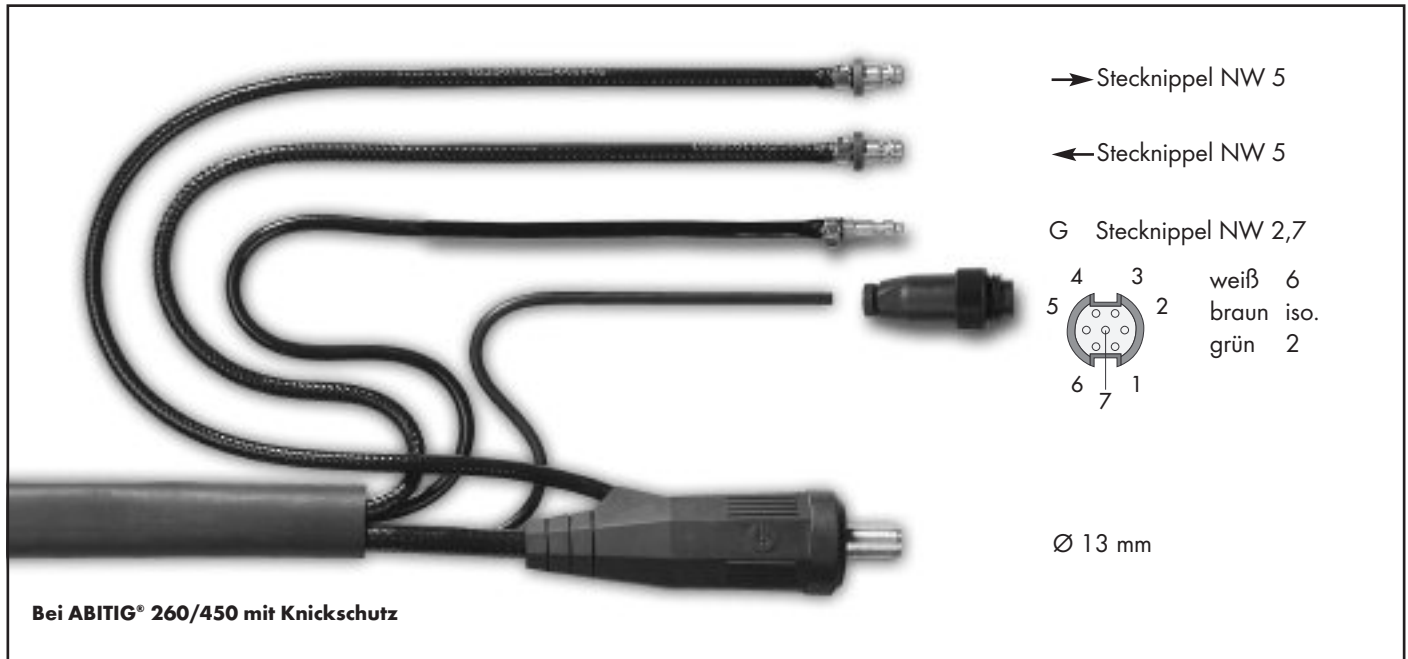

Brennertyp	Länge	Schalterfunktion	maschinenseitiger Anschluss	Schlauchpaketausführung	Bestellnummer
ABITIG® 18	4 m	ED	BSB 35-50 Rundsteckverbinder 7-pol.	Standard	7S4SK043010025C22
	8 m	ED	BSB 35-50 Rundsteckverbinder 7-pol.	Standard	7S4SK083010025C22
	4 m	ED	BSB 35-50 Rundsteckverbinder 7-pol.	High Flex Leder	7S4SH043010025C22
	8 m	ED	BSB 35-50 Rundsteckverbinder 7-pol.	High Flex Leder	7S4SH083010025C22
ABITIG® 18F	4 m	ED	BSB 35-50 Rundsteckverbinder 7-pol.	Standard	7S4FK043010025C22
	8 m	ED	BSB 35-50 Rundsteckverbinder 7-pol.	Standard	7S4FK083010025C22
	4 m	ED	BSB 35-50 Rundsteckverbinder 7-pol.	High Flex Leder	7S4FH043010025C22
	8 m	ED	BSB 35-50 Rundsteckverbinder 7-pol.	High Flex Leder	7S4FH083010025C22
ABITIG® 20	4 m	ED	BSB 35-50 Rundsteckverbinder 7-pol.	Standard	7S5SK043010025C22
	8 m	ED	BSB 35-50 Rundsteckverbinder 7-pol.	Standard	7S5SK083010025C22
	4 m	ED	BSB 35-50 Rundsteckverbinder 7-pol.	High Flex Leder	7S5SH043010025C22
	8 m	ED	BSB 35-50 Rundsteckverbinder 7-pol.	High Flex Leder	7S5SH083010025C22
ABITIG® 20F	4 m	ED	BSB 35-50 Rundsteckverbinder 7-pol.	Standard	7S5FK043010025C22
	8 m	ED	BSB 35-50 Rundsteckverbinder 7-pol.	Standard	7S5FK083010025C22
	4 m	ED	BSB 35-50 Rundsteckverbinder 7-pol.	High Flex Leder	7S5FH043010025C22
	8 m	ED	BSB 35-50 Rundsteckverbinder 7-pol.	High Flex Leder	7S5FH083010025C22

Technische Änderungen vorbehalten • Verkaufspreise = unverbindliche Preisempfehlung - Angebot freibleibend • © Copyright

ABITIG®-Brennerpreisliste

passend für WIG-Stromquellen des Fabrikates „migatronic“

Brennertyp	Länge	Schalterfunktion	maschinenseitiger Anschluss	Schlauchpaketausführung	Bestellnummer
ABITIG® 12-1	4 m	ED	BSB 35-50 Rundsteckverbinder 7-pol.	Standard	7S6SK043010025C22
	8 m	ED	BSB 35-50 Rundsteckverbinder 7-pol.	Standard	7S6SK083010025C22
	4 m	ED	BSB 35-50 Rundsteckverbinder 7-pol.	High Flex Leder	7S6SH043010025C22
	8 m	ED	BSB 35-50 Rundsteckverbinder 7-pol.	High Flex Leder	7S6SH083010025C22
ABITIG® 18SC	4 m	ED	BSB 35-50 Rundsteckverbinder 7-pol.	Standard	7S7SK043010025C22
	8 m	ED	BSB 35-50 Rundsteckverbinder 7-pol.	Standard	7S7SK083010025C22
	4 m	ED	BSB 35-50 Rundsteckverbinder 7-pol.	High Flex Leder	7S7SH043010025C22
	8 m	ED	BSB 35-50 Rundsteckverbinder 7-pol.	High Flex Leder	7S7SH083010025C22
ABITIG® 24W	4 m	ED	BSB 35-50 Rundsteckverbinder 7-pol.	Standard	7S9SK043010025C22
	8 m	ED	BSB 35-50 Rundsteckverbinder 7-pol.	Standard	7S9SK083010025C22
	4 m	ED	BSB 35-50 Rundsteckverbinder 7-pol.	High Flex Leder	7S9SH043010025C22
	8 m	ED	BSB 35-50 Rundsteckverbinder 7-pol.	High Flex Leder	7S9SH083010025C22
ABITIG® 450W	4 m	ED	BSB 35-50 Rundsteckverbinder 7-pol.	Standard	7T5SK043010125C22
	8 m	ED	BSB 35-50 Rundsteckverbinder 7-pol.	Standard	7T5SK083010125C22
	4 m	ED	BSB 35-50 Rundsteckverbinder 7-pol.	High Flex Leder	7T5SH043010125C22
	8 m	ED	BSB 35-50 Rundsteckverbinder 7-pol.	High Flex Leder	7T5SH083010125C22
ABITIG® 260W	4 m	ED	BSB 35-50 Rundsteckverbinder 7-pol.	Standard	7T7SK043010125C22
	8 m	ED	BSB 35-50 Rundsteckverbinder 7-pol.	Standard	7T7SK083010125C22
	4 m	ED	BSB 35-50 Rundsteckverbinder 7-pol.	High Flex Leder	7T7SH043010125C22
	8 m	ED	BSB 35-50 Rundsteckverbinder 7-pol.	High Flex Leder	7T7SH083010125C22
ABITIG® 450W SC	4 m	ED	BSB 35-50 Rundsteckverbinder 7-pol.	Standard	
	8 m	ED	BSB 35-50 Rundsteckverbinder 7-pol.	Standard	
	4 m	ED	BSB 35-50 Rundsteckverbinder 7-pol.	High Flex Leder	7T8SH043010125C22
	8 m	ED	BSB 35-50 Rundsteckverbinder 7-pol.	High Flex Leder	7T8SH083010125C22

ABITIG®-Brennerpreisliste

passend für WIG-Stromquellen des Fabrikates „migatronic“

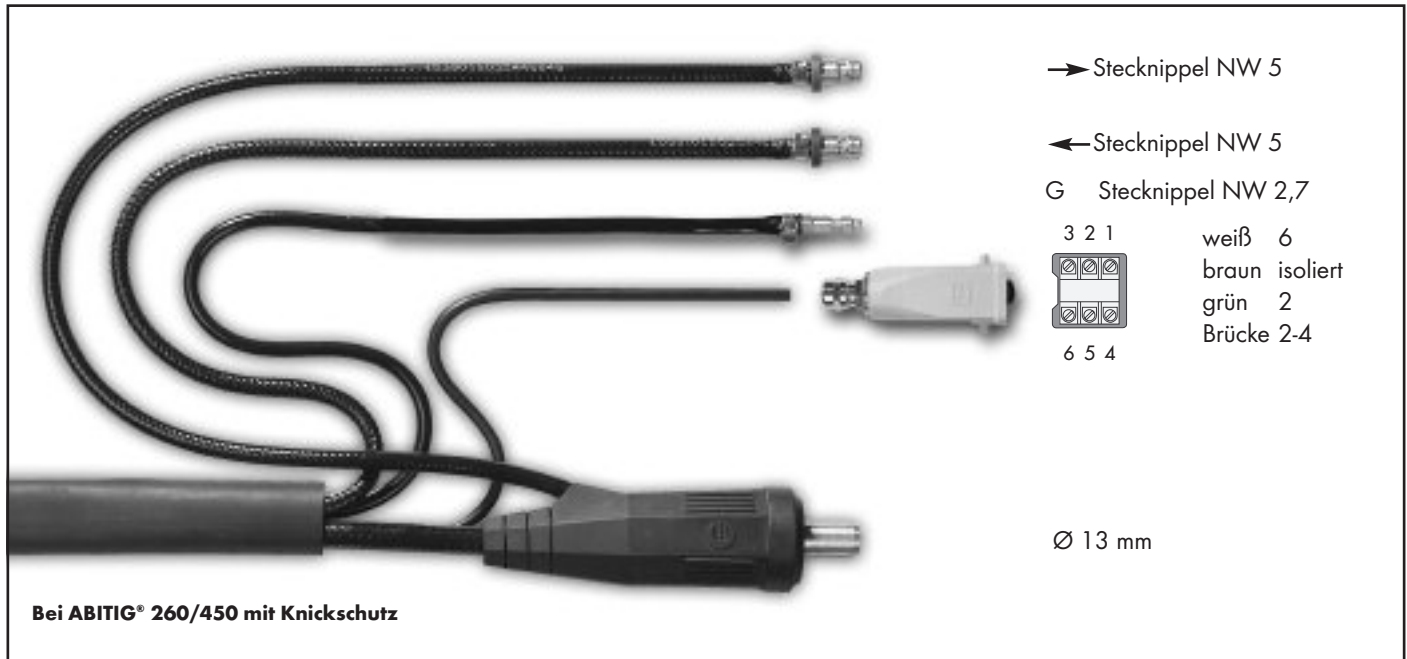

Brennertyp	Länge	Schalterfunktion	maschinenseitiger Anschluss	Schlauchpaketausführung	Bestellnummer
ABITIG® 18	4 m	ED	BSB 35-50 Harting 6-pol.	Standard	7S4SK043010011C22
	8 m	ED	BSB 35-50 Harting 6-pol.	Standard	7S4SK083010011C22
	4 m	ED	BSB 35-50 Harting 6-pol.	High Flex Leder	7S4SH043010011C22
	8 m	ED	BSB 35-50 Harting 6-pol.	High Flex Leder	7S4SH083010011C22
ABITIG® 18F	4 m	ED	BSB 35-50 Harting 6-pol.	Standard	7S4FK043010011C22
	8 m	ED	BSB 35-50 Harting 6-pol.	Standard	7S4FK083010011C22
	4 m	ED	BSB 35-50 Harting 6-pol.	High Flex Leder	7S4FH043010011C22
	8 m	ED	BSB 35-50 Harting 6-pol.	High Flex Leder	7S4FH083010011C22
ABITIG® 20	4 m	ED	BSB 35-50 Harting 6-pol.	Standard	7S5SK043010011C22
	8 m	ED	BSB 35-50 Harting 6-pol.	Standard	7S5SK083010011C22
	4 m	ED	BSB 35-50 Harting 6-pol.	High Flex Leder	7S5SH043010011C22
	8 m	ED	BSB 35-50 Harting 6-pol.	High Flex Leder	7S5SH083010011C22
ABITIG® 20F	4 m	ED	BSB 35-50 Harting 6-pol.	Standard	7S5FK043010011C22
	8 m	ED	BSB 35-50 Harting 6-pol.	Standard	7S5FK083010011C22
	4 m	ED	BSB 35-50 Harting 6-pol.	High Flex Leder	7S5FH043010011C22
	8 m	ED	BSB 35-50 Harting 6-pol.	High Flex Leder	7S5FH083010011C22

Technische Änderungen vorbehalten • Verkaufspreise = unverbindliche Preisempfehlung - Angebot freibleibend • © Copyright

ABITIG®-Brennerpreisliste

passend für WIG-Stromquellen des Fabrikates „migatronic“

Brennertyp	Länge	Schalterfunktion	maschinenseitiger Anschluss	Schlauchpaketausführung	Bestellnummer
ABITIG® 12-1	4 m	ED	BSB 35-50 Harting 6-pol.	Standard	7S6SK043010011C22
	8 m	ED	BSB 35-50 Harting 6-pol.	Standard	7S6SK083010011C22
	4 m	ED	BSB 35-50 Harting 6-pol.	High Flex Leder	7S6SH043010011C22
	8 m	ED	BSB 35-50 Harting 6-pol.	High Flex Leder	7S6SH083010011C22

ABITIG® 18SC	4 m	ED	BSB 35-50 Harting 6-pol.	Standard	7S7SK043010011C22
	8 m	ED	BSB 35-50 Harting 6-pol.	Standard	7S7SK083010011C22
	4 m	ED	BSB 35-50 Harting 6-pol.	High Flex Leder	7S7SH043010011C22
	8 m	ED	BSB 35-50 Harting 6-pol.	High Flex Leder	7S7SH083010011C22

ABITIG® 24W	4 m	ED	BSB 35-50 Harting 6-pol.	Standard	7S9SK043010011C22
	8 m	ED	BSB 35-50 Harting 6-pol.	Standard	7S9SK083010011C22
	4 m	ED	BSB 35-50 Harting 6-pol.	High Flex Leder	7S9SH043010011C22
	8 m	ED	BSB 35-50 Harting 6-pol.	High Flex Leder	7S9SH083010011C22

ABITIG® 450W	4 m	ED	BSB 35-50 Harting 6-pol.	Standard	7T5SK043010111C22
	8 m	ED	BSB 35-50 Harting 6-pol.	Standard	7T5SK083010111C22
	4 m	ED	BSB 35-50 Harting 6-pol.	High Flex Leder	7T5SH043010111C22
	8 m	ED	BSB 35-50 Harting 6-pol.	High Flex Leder	7T5SH083010111C22

ABITIG® 260W	4 m	ED	BSB 35-50 Harting 6-pol.	Standard	7T7SK043010111C22
	8 m	ED	BSB 35-50 Harting 6-pol.	Standard	7T7SK083010111C22
	4 m	ED	BSB 35-50 Harting 6-pol.	High Flex Leder	7T7SH043010111C22
	8 m	ED	BSB 35-50 Harting 6-pol.	High Flex Leder	7T7SH083010111C22

ABITIG® 450W SC	4 m	ED	BSB 35-50 Harting 6-pol.	Standard	
	8 m	ED	BSB 35-50 Harting 6-pol.	Standard	
	4 m	ED	BSB 35-50 Harting 6-pol.	High Flex Leder	7T8SH043010111C22
	8 m	ED	BSB 35-50 Harting 6-pol.	High Flex Leder	7T8SH083010111C22

ABITIG®-Brennerpreisliste

passend für WIG-Stromquellen des Fabrikates „migatronic“



Brennertyp	Länge	Schalterfunktion	maschinenseitiger Anschluss	Schlauchpaketausführung	Bestellnummer
ABITIG® 18	4 m	ED	ZA 9-pol.	Standard	7S4SK043010799D12
	8 m	ED	ZA 9-pol.	Standard	7S4SK083010799D12
	4 m	ED	ZA 9-pol.	High Flex Leder	7S4SH043010799D12
	8 m	ED	ZA 9-pol.	High Flex Leder	7S4SH083010799D12
ABITIG® 18F	4 m	ED	ZA 9-pol.	Standard	7S4FK043010799D12
	8 m	ED	ZA 9-pol.	Standard	7S4FK083010799D12
	4 m	ED	ZA 9-pol.	High Flex Leder	7S4FH043010799D12
	8 m	ED	ZA 9-pol.	High Flex Leder	7S4FH083010799D12
ABITIG® 20	4 m	ED	ZA 9-pol.	Standard	7S5SK043010799D12
	8 m	ED	ZA 9-pol.	Standard	7S5SK083010799D12
	4 m	ED	ZA 9-pol.	High Flex Leder	7S5SH043010799D12
	8 m	ED	ZA 9-pol.	High Flex Leder	7S5SH083010799D12
ABITIG® 20F	4 m	ED	ZA 9-pol.	Standard	7S5FK043010799D12
	8 m	ED	ZA 9-pol.	Standard	7S5FK083010799D12
	4 m	ED	ZA 9-pol.	High Flex Leder	7S5FH043010799D12
	8 m	ED	ZA 9-pol.	High Flex Leder	7S5FH083010799D12

Technische Änderungen vorbehalten • Verkaufspreise = unverbindliche Preisempfehlung - Angebot freibleibend • © Copyright

ABITIG®-Brennerpreisliste

passend für WIG-Stromquellen des Fabrikates „migatronic“

Brennertyp	Länge	Schalterfunktion	maschinenseitiger Anschluss	Schlauchpaketausführung	Bestellnummer
ABITIG® 12-1	4 m	ED	ZA 9-pol.	Standard	7S6SK043010799D12
	8 m	ED	ZA 9-pol.	Standard	7S6SK083010799D12
	4 m	ED	ZA 9-pol.	High Flex Leder	7S6SH043010799D12
	8 m	ED	ZA 9-pol.	High Flex Leder	7S6SH083010799D12
ABITIG® 18SC	4 m	ED	ZA 9-pol.	Standard	7S7SK043010799D12
	8 m	ED	ZA 9-pol.	Standard	7S7SK083010799D12
	4 m	ED	ZA 9-pol.	High Flex Leder	7S7SH043010799D12
	8 m	ED	ZA 9-pol.	High Flex Leder	7S7SH083010799D12
ABITIG® 24W	4 m	ED	ZA 9-pol.	Standard	7S9SK043010799D12
	8 m	ED	ZA 9-pol.	Standard	7S9SK083010799D12
	4 m	ED	ZA 9-pol.	High Flex Leder	7S9SH043010799D12
	8 m	ED	ZA 9-pol.	High Flex Leder	7S9SH083010799D12
ABITIG® 450W	4 m	ED	ZA 9-pol.	Standard	7T5SK043010799D12
	8 m	ED	ZA 9-pol.	Standard	7T5SK083010799D12
	4 m	ED	ZA 9-pol.	High Flex Leder	7T5SH043010799D12
	8 m	ED	ZA 9-pol.	High Flex Leder	7T5SH083010799D12
ABITIG® 260W	4 m	ED	ZA 9-pol.	Standard	7T7SK043010799D12
	8 m	ED	ZA 9-pol.	Standard	7T7SK083010799D12
	4 m	ED	ZA 9-pol.	High Flex Leder	7T7SH043010799D12
	8 m	ED	ZA 9-pol.	High Flex Leder	7T7SH083010799D12
ABITIG® 450W SC	4 m	ED	ZA 9-pol.	Standard	
	8 m	ED	ZA 9-pol.	Standard	
	4 m	ED	ZA 9-pol.	High Flex Leder	7T8SH043010799D12
	8 m	ED	ZA 9-pol.	High Flex Leder	7T8SH083010799D12

ABITIG®-Brennerpreisliste

passend für WIG-Stromquellen des Fabrikates „migatronic“



Brennertyp	Länge	Schalterfunktion	maschinenseitiger Anschluss	Schlauchpaketausführung	Bestellnummer
ABITIG® 18	4 m	EDP	ZA 9-pol.	Standard	7S4SK043090799D12
	8 m	EDP	ZA 9-pol.	Standard	7S4SK083090799D12
	4 m	EDP	ZA 9-pol.	High Flex Leder	7S4SH043090799D12
	8 m	EDP	ZA 9-pol.	High Flex Leder	7S4SH083090799D12
ABITIG® 18F	4 m	EDP	ZA 9-pol.	Standard	7S4FK043090799D12
	8 m	EDP	ZA 9-pol.	Standard	7S4FK083090799D12
	4 m	EDP	ZA 9-pol.	High Flex Leder	7S4FH043090799D12
	8 m	EDP	ZA 9-pol.	High Flex Leder	7S4FH083090799D12
ABITIG® 20	4 m	EDP	ZA 9-pol.	Standard	7S5SK043090799D12
	8 m	EDP	ZA 9-pol.	Standard	7S5SK083090799D12
	4 m	EDP	ZA 9-pol.	High Flex Leder	7S5SH043090799D12
	8 m	EDP	ZA 9-pol.	High Flex Leder	7S5SH083090799D12
ABITIG® 20F	4 m	EDP	ZA 9-pol.	Standard	7S5FK043090799D12
	8 m	EDP	ZA 9-pol.	Standard	7S5FK083090799D12
	4 m	EDP	ZA 9-pol.	High Flex Leder	7S5FH043090799D12
	8 m	EDP	ZA 9-pol.	High Flex Leder	7S5FH083090799D12

Technische Änderungen vorbehalten • Verkaufspreise = unverbindliche Preisempfehlung - Angebot freibleibend • © Copyright

ABITIG®-Brennerpreisliste

passend für WIG-Stromquellen des Fabrikates „migatronic“

Brennertyp	Länge	Schalterfunktion	maschinenseitiger Anschluss	Schlauchpaketausführung	Bestellnummer
ABITIG® 12-1	4 m	EDP	ZA 9-pol.	Standard	7S6SK043090799D12
	8 m	EDP	ZA 9-pol.	Standard	7S6SK083090799D12
	4 m	EDP	ZA 9-pol.	High Flex Leder	7S6SH043090799D12
	8 m	EDP	ZA 9-pol.	High Flex Leder	7S6SH083090799D12
ABITIG® 18SC	4 m	EDP	ZA 9-pol.	Standard	7S7SK043090799D12
	8 m	EDP	ZA 9-pol.	Standard	7S7SK083090799D12
	4 m	EDP	ZA 9-pol.	High Flex Leder	7S7SH043090799D12
	8 m	EDP	ZA 9-pol.	High Flex Leder	7S7SH083090799D12
ABITIG® 24W	4 m	EDP	ZA 9-pol.	Standard	7S9SK043090799D12
	8 m	EDP	ZA 9-pol.	Standard	7S9SK083090799D12
	4 m	EDP	ZA 9-pol.	High Flex Leder	7S9SH043090799D12
	8 m	EDP	ZA 9-pol.	High Flex Leder	7S9SH083090799D12
ABITIG® 450W	4 m	EDP	ZA 9-pol.	Standard	7T5SK043090799D12
	8 m	EDP	ZA 9-pol.	Standard	7T5SK083090799D12
	4 m	EDP	ZA 9-pol.	High Flex Leder	7T5SH043090799D12
	8 m	EDP	ZA 9-pol.	High Flex Leder	7T5SH083090799D12
ABITIG® 260W	4 m	EDP	ZA 9-pol.	Standard	7T7SK043090799D12
	8 m	EDP	ZA 9-pol.	Standard	7T7SK083090799D12
	4 m	EDP	ZA 9-pol.	High Flex Leder	7T7SH043090799D12
	8 m	EDP	ZA 9-pol.	High Flex Leder	7T7SH083090799D12
ABITIG® 450W SC	4 m	EDP	ZA 9-pol.	Standard	
	8 m	EDP	ZA 9-pol.	Standard	
	4 m	EDP	ZA 9-pol.	High Flex Leder	7T8SH043090799D12
	8 m	EDP	ZA 9-pol.	High Flex Leder	7T8SH083090799D12

ABITIG®-Brennerpreisliste

passend für WIG-Stromquellen des Fabrikates „migomat“

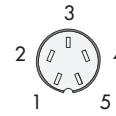

weiß 2
braun 3
grün 1
Brücke 4-5

Brennertyp	Länge	Schalterfunktion	maschinenseitiger Anschluss	Schlauchpaketausführung	Bestellnummer
ABITIG® 9	4 m	ED/DD	ZA - GZ Tuchel 5-pol.	Standard	7S1SK043020302A00
	8 m	ED/DD	ZA - GZ Tuchel 5-pol.	Standard	7S1SK083020302A00
	4 m	ED/DD	ZA - GZ Tuchel 5-pol.	High Flex Leder	7S1SH043020302A00
	8 m	ED/DD	ZA - GZ Tuchel 5-pol.	High Flex Leder	7S1SH083020302A00
ABITIG® 9F	4 m	ED/DD	ZA - GZ Tuchel 5-pol.	Standard	7S1FK043020302A00
	8 m	ED/DD	ZA - GZ Tuchel 5-pol.	Standard	7S1FK083020302A00
	4 m	ED/DD	ZA - GZ Tuchel 5-pol.	High Flex Leder	7S1FH043020302A00
	8 m	ED/DD	ZA - GZ Tuchel 5-pol.	High Flex Leder	7S1FH083020302A00
ABITIG® 17	4 m	ED/DD	ZA - GZ Tuchel 5-pol.	Standard	7S2SK043020302A00
	8 m	ED/DD	ZA - GZ Tuchel 5-pol.	Standard	7S2SK083020302A00
	4 m	ED/DD	ZA - GZ Tuchel 5-pol.	High Flex Leder	7S2SH043020302A00
	8 m	ED/DD	ZA - GZ Tuchel 5-pol.	High Flex Leder	7S2SH083020302A00
ABITIG® 17F	4 m	ED/DD	ZA - GZ Tuchel 5-pol.	Standard	7S2FK043020302A00
	8 m	ED/DD	ZA - GZ Tuchel 5-pol.	Standard	7S2FK083020302A00
	4 m	ED/DD	ZA - GZ Tuchel 5-pol.	High Flex Leder	7S2FH043020302A00
	8 m	ED/DD	ZA - GZ Tuchel 5-pol.	High Flex Leder	7S2FH083020302A00

Technische Änderungen vorbehalten • Verkaufspreise = unverbindliche Preisempfehlung - Angebot freibleibend • © Copyright

ABITIG®-Brennerpreisliste

passend für WIG-Stromquellen des Fabrikates „migomat“

Brennertyp	Länge	Schalterfunktion	maschinenseitiger Anschluss	Schlauchpaketausführung	Bestellnummer
ABITIG® 26	4 m	ED/DD	ZA - GZ Tuchel 5-pol.	Standard	7S3SK043020302A00
	8 m	ED/DD	ZA - GZ Tuchel 5-pol.	Standard	7S3SK083020302A00
	4 m	ED/DD	ZA - GZ Tuchel 5-pol.	High Flex Leder	7S3SH043020302A00
	8 m	ED/DD	ZA - GZ Tuchel 5-pol.	High Flex Leder	7S3SH083020302A00
ABITIG® 26F	4 m	ED/DD	ZA - GZ Tuchel 5-pol.	Standard	7S3FK043020302A00
	8 m	ED/DD	ZA - GZ Tuchel 5-pol.	Standard	7S3FK083020302A00
	4 m	ED/DD	ZA - GZ Tuchel 5-pol.	High Flex Leder	7S3FH043020302A00
	8 m	ED/DD	ZA - GZ Tuchel 5-pol.	High Flex Leder	7S3FH083020302A00
ABITIG® 24G	4 m	ED/DD	ZA - GZ Tuchel 5-pol.	Standard	7S8SK043020302A00
	8 m	ED/DD	ZA - GZ Tuchel 5-pol.	Standard	7S8SK083020302A00
	4 m	ED/DD	ZA - GZ Tuchel 5-pol.	High Flex Leder	7S8SH043020302A00
	8 m	ED/DD	ZA - GZ Tuchel 5-pol.	High Flex Leder	7S8SH083020302A00
ABITIG® 200	4 m	ED/DD	ZA - GZ Tuchel 5-pol.	Standard	7T4SK043020302A00
	8 m	ED/DD	ZA - GZ Tuchel 5-pol.	Standard	7T4SK083020302A00
	4 m	ED/DD	ZA - GZ Tuchel 5-pol.	High Flex Leder	7T4SH043020302A00
	8 m	ED/DD	ZA - GZ Tuchel 5-pol.	High Flex Leder	7T4SH083020302A00
ABITIG® 200F	4 m	ED/DD	ZA - GZ Tuchel 5-pol.	Standard	7T4FK043020302A00
	8 m	ED/DD	ZA - GZ Tuchel 5-pol.	Standard	7T4FK083020302A00
	4 m	ED/DD	ZA - GZ Tuchel 5-pol.	High Flex Leder	7T4FH043020302A00
	8 m	ED/DD	ZA - GZ Tuchel 5-pol.	High Flex Leder	7T4FH083020302A00
ABITIG® 150	4 m	ED/DD	ZA - GZ Tuchel 5-pol.	Standard	7T6SK043020302A00
	8 m	ED/DD	ZA - GZ Tuchel 5-pol.	Standard	7T6SK083020302A00
	4 m	ED/DD	ZA - GZ Tuchel 5-pol.	High Flex Leder	7T6SH043020302A00
	8 m	ED/DD	ZA - GZ Tuchel 5-pol.	High Flex Leder	7T6SH083020302A00
ABITIG® 150F	4 m	ED/DD	ZA - GZ Tuchel 5-pol.	Standard	7T6FK043020302A00
	8 m	ED/DD	ZA - GZ Tuchel 5-pol.	Standard	7T6FK083020302A00
	4 m	ED/DD	ZA - GZ Tuchel 5-pol.	High Flex Leder	7T6FH043020302A00
	8 m	ED/DD	ZA - GZ Tuchel 5-pol.	High Flex Leder	7T6FH083020302A00

ABITIG®-Brennerpreisliste

passend für WIG-Stromquellen des Fabrikates „migomat“



Brennertyp	Länge	Schalterfunktion	maschinenseitiger Anschluss	Schlauchpaketausführung	Bestellnummer
ABITIG® 18	4 m	ED/DD	ZA - WZ-0 Tuchel 5-pol.	Standard	7S4SK043020302A12
	8 m	ED/DD	ZA - WZ-0 Tuchel 5-pol.	Standard	7S4SK083020302A12
	4 m	ED/DD	ZA - WZ-0 Tuchel 5-pol.	High Flex Leder	7S4SH043020302A12
	8 m	ED/DD	ZA - WZ-0 Tuchel 5-pol.	High Flex Leder	7S4SH083020302A12
ABITIG® 18F	4 m	ED/DD	ZA - WZ-0 Tuchel 5-pol.	Standard	7S4FK043020302A12
	8 m	ED/DD	ZA - WZ-0 Tuchel 5-pol.	Standard	7S4FK083020302A12
	4 m	ED/DD	ZA - WZ-0 Tuchel 5-pol.	High Flex Leder	7S4FH043020302A12
	8 m	ED/DD	ZA - WZ-0 Tuchel 5-pol.	High Flex Leder	7S4FH083020302A12
ABITIG® 20	4 m	ED/DD	ZA - WZ-0 Tuchel 5-pol.	Standard	7S5SK043020302A12
	8 m	ED/DD	ZA - WZ-0 Tuchel 5-pol.	Standard	7S5SK083020302A12
	4 m	ED/DD	ZA - WZ-0 Tuchel 5-pol.	High Flex Leder	7S5SH043020302A12
	8 m	ED/DD	ZA - WZ-0 Tuchel 5-pol.	High Flex Leder	7S5SH083020302A12
ABITIG® 20F	4 m	ED/DD	ZA - WZ-0 Tuchel 5-pol.	Standard	7S5FK043020302A12
	8 m	ED/DD	ZA - WZ-0 Tuchel 5-pol.	Standard	7S5FK083020302A12
	4 m	ED/DD	ZA - WZ-0 Tuchel 5-pol.	High Flex Leder	7S5FH043020302A12
	8 m	ED/DD	ZA - WZ-0 Tuchel 5-pol.	High Flex Leder	7S5FH083020302A12

Technische Änderungen vorbehalten • Verkaufspreise = unverbindliche Preisempfehlung - Angebot freibleibend • © Copyright

ABITIG®-Brennerpreisliste

passend für WIG-Stromquellen des Fabrikates „migomat“

Brennertyp	Länge	Schalterfunktion	maschinenseitiger Anschluss	Schlauchpaketausführung	Bestellnummer
ABITIG® 12-1	4 m	ED/DD	ZA - WZ-0 Tuchel 5-pol.	Standard	7S6SK043020302A12
	8 m	ED/DD	ZA - WZ-0 Tuchel 5-pol.	Standard	7S6SK083020302A12
	4 m	ED/DD	ZA - WZ-0 Tuchel 5-pol.	High Flex Leder	7S6SH043020302A12
	8 m	ED/DD	ZA - WZ-0 Tuchel 5-pol.	High Flex Leder	7S6SH083020302A12
ABITIG® 18SC	4 m	ED/DD	ZA - WZ-0 Tuchel 5-pol.	Standard	7S7SK043020302A12
	8 m	ED/DD	ZA - WZ-0 Tuchel 5-pol.	Standard	7S7SK083020302A12
	4 m	ED/DD	ZA - WZ-0 Tuchel 5-pol.	High Flex Leder	7S7SH043020302A12
	8 m	ED/DD	ZA - WZ-0 Tuchel 5-pol.	High Flex Leder	7S7SH083020302A12
ABITIG® 24W	4 m	ED/DD	ZA - WZ-0 Tuchel 5-pol.	Standard	7S9SK043020302A12
	8 m	ED/DD	ZA - WZ-0 Tuchel 5-pol.	Standard	7S9SK083020302A12
	4 m	ED/DD	ZA - WZ-0 Tuchel 5-pol.	High Flex Leder	7S9SH043020302A12
	8 m	ED/DD	ZA - WZ-0 Tuchel 5-pol.	High Flex Leder	7S9SH083020302A12
ABITIG® 450W	4 m	ED/DD	ZA - WZ-0 Tuchel 5-pol.	Standard	7T5SK043020302A12
	8 m	ED/DD	ZA - WZ-0 Tuchel 5-pol.	Standard	7T5SK083020302A12
	4 m	ED/DD	ZA - WZ-0 Tuchel 5-pol.	High Flex Leder	7T5SH043020302A12
	8 m	ED/DD	ZA - WZ-0 Tuchel 5-pol.	High Flex Leder	7T5SH083020302A12
ABITIG® 260W	4 m	ED/DD	ZA - WZ-0 Tuchel 5-pol.	Standard	7T7SK043020302A12
	8 m	ED/DD	ZA - WZ-0 Tuchel 5-pol.	Standard	7T7SK083020302A12
	4 m	ED/DD	ZA - WZ-0 Tuchel 5-pol.	High Flex Leder	7T7SH043020302A12
	8 m	ED/DD	ZA - WZ-0 Tuchel 5-pol.	High Flex Leder	7T7SH083020302A12
ABITIG® 450W SC	4 m	ED/DD	ZA - WZ-0 Tuchel 5-pol.	Standard	
	8 m	ED/DD	ZA - WZ-0 Tuchel 5-pol.	Standard	
	4 m	ED/DD	ZA - WZ-0 Tuchel 5-pol.	High Flex Leder	7T8SH043020302A12
	8 m	ED/DD	ZA - WZ-0 Tuchel 5-pol.	High Flex Leder	7T8SH083020302A12

ABITIG®-Brennerpreisliste

passend für WIG-Stromquellen des Fabrikates „nimak“



Brennertyp	Länge	Schalterfunktion	maschinenseitiger Anschluss	Schlauchpaketausführung	Bestellnummer
ABITIG® 9	4 m	ED/DD	BSB 35-50 Tuchel 5-pol.	Standard	7S1SK043020001A06
	8 m	ED/DD	BSB 35-50 Tuchel 5-pol.	Standard	7S1SK083020001A06
	4 m	ED/DD	BSB 35-50 Tuchel 5-pol.	High Flex Leder	7S1SH043020001A06
	8 m	ED/DD	BSB 35-50 Tuchel 5-pol.	High Flex Leder	7S1SH083020001A06

ABITIG® 9F	4 m	ED/DD	BSB 35-50 Tuchel 5-pol.	Standard	7S1FK043020001A06
	8 m	ED/DD	BSB 35-50 Tuchel 5-pol.	Standard	7S1FK083020001A06
	4 m	ED/DD	BSB 35-50 Tuchel 5-pol.	High Flex Leder	7S1FH043020001A06
	8 m	ED/DD	BSB 35-50 Tuchel 5-pol.	High Flex Leder	7S1FH083020001A06

ABITIG® 17	4 m	ED/DD	BSB 35-50 Tuchel 5-pol.	Standard	7S2SK043020001A06
	8 m	ED/DD	BSB 35-50 Tuchel 5-pol.	Standard	7S2SK083020001A06
	4 m	ED/DD	BSB 35-50 Tuchel 5-pol.	High Flex Leder	7S2SH043020001A06
	8 m	ED/DD	BSB 35-50 Tuchel 5-pol.	High Flex Leder	7S2SH083020001A06

ABITIG® 17F	4 m	ED/DD	BSB 35-50 Tuchel 5-pol.	Standard	7S2FK043020001A06
	8 m	ED/DD	BSB 35-50 Tuchel 5-pol.	Standard	7S2FK083020001A06
	4 m	ED/DD	BSB 35-50 Tuchel 5-pol.	High Flex Leder	7S2FH043020001A06
	8 m	ED/DD	BSB 35-50 Tuchel 5-pol.	High Flex Leder	7S2FH083020001A06

Technische Änderungen vorbehalten • Verkaufspreise = unverbindliche Preisempfehlung - Angebot freibleibend • © Copyright

ABITIG®-Brennerpreisliste

passend für WIG-Stromquellen des Fabrikates „nimak“

Brennertyp	Länge	Schalterfunktion	maschinenseitiger Anschluss	Schlauchpaketausführung	Bestellnummer
ABITIG® 26	4 m	ED/DD	BSB 35-50 Tuchel 5-pol.	Standard	7S3SK043020001A06
	8 m	ED/DD	BSB 35-50 Tuchel 5-pol.	Standard	7S3SK083020001A06
	4 m	ED/DD	BSB 35-50 Tuchel 5-pol.	High Flex Leder	7S3SH043020001A06
	8 m	ED/DD	BSB 35-50 Tuchel 5-pol.	High Flex Leder	7S3SH083020001A06
ABITIG® 26F	4 m	ED/DD	BSB 35-50 Tuchel 5-pol.	Standard	7S3FK043020001A06
	8 m	ED/DD	BSB 35-50 Tuchel 5-pol.	Standard	7S3FK083020001A06
	4 m	ED/DD	BSB 35-50 Tuchel 5-pol.	High Flex Leder	7S3FH043020001A06
	8 m	ED/DD	BSB 35-50 Tuchel 5-pol.	High Flex Leder	7S3FH083020001A06
ABITIG® 24G	4 m	ED/DD	BSB 35-50 Tuchel 5-pol.	Standard	7S8SK043020001A06
	8 m	ED/DD	BSB 35-50 Tuchel 5-pol.	Standard	7S8SK083020001A06
	4 m	ED/DD	BSB 35-50 Tuchel 5-pol.	High Flex Leder	7S8SH043020001A06
	8 m	ED/DD	BSB 35-50 Tuchel 5-pol.	High Flex Leder	7S8SH083020001A06
ABITIG® 200	4 m	ED/DD	BSB 35-50 Tuchel 5-pol.	Standard	7T4SK043020001A06
	8 m	ED/DD	BSB 35-50 Tuchel 5-pol.	Standard	7T4SK083020001A06
	4 m	ED/DD	BSB 35-50 Tuchel 5-pol.	High Flex Leder	7T4SH043020001A06
	8 m	ED/DD	BSB 35-50 Tuchel 5-pol.	High Flex Leder	7T4SH083020001A06
ABITIG® 200F	4 m	ED/DD	BSB 35-50 Tuchel 5-pol.	Standard	7T4FK043020001A06
	8 m	ED/DD	BSB 35-50 Tuchel 5-pol.	Standard	7T4FK083020001A06
	4 m	ED/DD	BSB 35-50 Tuchel 5-pol.	High Flex Leder	7T4FH043020001A06
	8 m	ED/DD	BSB 35-50 Tuchel 5-pol.	High Flex Leder	7T4FH083020001A06
ABITIG® 150	4 m	ED/DD	BSB 35-50 Tuchel 5-pol.	Standard	7T6SK043020001A06
	8 m	ED/DD	BSB 35-50 Tuchel 5-pol.	Standard	7T6SK083020001A06
	4 m	ED/DD	BSB 35-50 Tuchel 5-pol.	High Flex Leder	7T6SH043020001A06
	8 m	ED/DD	BSB 35-50 Tuchel 5-pol.	High Flex Leder	7T6SH083020001A06
ABITIG® 150F	4 m	ED/DD	BSB 35-50 Tuchel 5-pol.	Standard	7T6FK043020001A06
	8 m	ED/DD	BSB 35-50 Tuchel 5-pol.	Standard	7T6FK083020001A06
	4 m	ED/DD	BSB 35-50 Tuchel 5-pol.	High Flex Leder	7T6FH043020001A06
	8 m	ED/DD	BSB 35-50 Tuchel 5-pol.	High Flex Leder	7T6FH083020001A06

ABITIG®-Brennerpreisliste

passend für WIG-Stromquellen des Fabrikates „nimak“



Brennertyp	Länge	Schalterfunktion	maschinenseitiger Anschluss	Schlauchpaketausführung	Bestellnummer
ABITIG® 9	4 m	ED/DD	ZA - WTG-5	Standard	7S1SK043020498A00
	8 m	ED/DD	ZA - WTG-5	Standard	7S1SK083020498A00
	4 m	ED/DD	ZA - WTG-5	High Flex Leder	7S1SH043020498A00
	8 m	ED/DD	ZA - WTG-5	High Flex Leder	7S1SH083020498A00

ABITIG® 9F	4 m	ED/DD	ZA - WTG-5	Standard	7S1FK043020498A00
	8 m	ED/DD	ZA - WTG-5	Standard	7S1FK083020498A00
	4 m	ED/DD	ZA - WTG-5	High Flex Leder	7S1FH043020498A00
	8 m	ED/DD	ZA - WTG-5	High Flex Leder	7S1FH083020498A00

ABITIG® 17	4 m	ED/DD	ZA - WTG-5	Standard	7S2SK043020498A00
	8 m	ED/DD	ZA - WTG-5	Standard	7S2SK083020498A00
	4 m	ED/DD	ZA - WTG-5	High Flex Leder	7S2SH043020498A00
	8 m	ED/DD	ZA - WTG-5	High Flex Leder	7S2SH083020498A00

ABITIG® 17F	4 m	ED/DD	ZA - WTG-5	Standard	7S2FK043020498A00
	8 m	ED/DD	ZA - WTG-5	Standard	7S2FK083020498A00
	4 m	ED/DD	ZA - WTG-5	High Flex Leder	7S2FH043020498A00
	8 m	ED/DD	ZA - WTG-5	High Flex Leder	7S2FH083020498A00

Technische Änderungen vorbehalten • Verkaufspreise = unverbindliche Preisempfehlung - Angebot freibleibend • © Copyright

ABITIG®-Brennerpreisliste

passend für WIG-Stromquellen des Fabrikates „nimak“

Brennertyp	Länge	Schalterfunktion	maschinenseitiger Anschluss	Schlauchpaketausführung	Bestellnummer
ABITIG® 26	4 m	ED/DD	ZA - WTG-5	Standard	7S3SK043020498A00
	8 m	ED/DD	ZA - WTG-5	Standard	7S3SK083020498A00
	4 m	ED/DD	ZA - WTG-5	High Flex Leder	7S3SH043020498A00
	8 m	ED/DD	ZA - WTG-5	High Flex Leder	7S3SH083020498A00

ABITIG® 26F	4 m	ED/DD	ZA - WTG-5	Standard	7S3FK043020498A00
	8 m	ED/DD	ZA - WTG-5	Standard	7S3FK083020498A00
	4 m	ED/DD	ZA - WTG-5	High Flex Leder	7S3FH043020498A00
	8 m	ED/DD	ZA - WTG-5	High Flex Leder	7S3FH083020498A00

ABITIG® 24G	4 m	ED/DD	ZA - WTG-5	Standard	7S8SK043020498A00
	8 m	ED/DD	ZA - WTG-5	Standard	7S8SK083020498A00
	4 m	ED/DD	ZA - WTG-5	High Flex Leder	7S8SH043020498A00
	8 m	ED/DD	ZA - WTG-5	High Flex Leder	7S8SH083020498A00

ABITIG® 200	4 m	ED/DD	ZA - WTG-5	Standard	7T4SK043020498A00
	8 m	ED/DD	ZA - WTG-5	Standard	7T4SK083020498A00
	4 m	ED/DD	ZA - WTG-5	High Flex Leder	7T4SH043020498A00
	8 m	ED/DD	ZA - WTG-5	High Flex Leder	7T4SH083020498A00

ABITIG® 200F	4 m	ED/DD	ZA - WTG-5	Standard	7T4FK043020498A00
	8 m	ED/DD	ZA - WTG-5	Standard	7T4FK083020498A00
	4 m	ED/DD	ZA - WTG-5	High Flex Leder	7T4FH043020498A00
	8 m	ED/DD	ZA - WTG-5	High Flex Leder	7T4FH083020498A00

ABITIG® 150	4 m	ED/DD	ZA - WTG-5	Standard	7T6SK043020498A00
	8 m	ED/DD	ZA - WTG-5	Standard	7T6SK083020498A00
	4 m	ED/DD	ZA - WTG-5	High Flex Leder	7T6SH043020498A00
	8 m	ED/DD	ZA - WTG-5	High Flex Leder	7T6SH083020498A00

ABITIG® 150F	4 m	ED/DD	ZA - WTG-5	Standard	7T6FK043020498A00
	8 m	ED/DD	ZA - WTG-5	Standard	7T6FK083020498A00
	4 m	ED/DD	ZA - WTG-5	High Flex Leder	7T6FH043020498A00
	8 m	ED/DD	ZA - WTG-5	High Flex Leder	7T6FH083020498A00

ABITIG®-Brennerpreisliste

passend für WIG-Stromquellen des Fabrikates „nimak“



Brennertyp	Länge	Schalterfunktion	maschinenseitiger Anschluss	Schlauchpaketausführung	Bestellnummer
ABITIG® 18	4 m	ED/DD	BSB 35-50 Tuchel 5-pol.	Standard	7S4SK043020001A11
	8 m	ED/DD	BSB 35-50 Tuchel 5-pol.	Standard	7S4SK083020001A11
	4 m	ED/DD	BSB 35-50 Tuchel 5-pol.	High Flex Leder	7S4SH043020001A11
	8 m	ED/DD	BSB 35-50 Tuchel 5-pol.	High Flex Leder	7S4SH083020001A11
ABITIG® 18F	4 m	ED/DD	BSB 35-50 Tuchel 5-pol.	Standard	7S4FK043020001A11
	8 m	ED/DD	BSB 35-50 Tuchel 5-pol.	Standard	7S4FK083020001A11
	4 m	ED/DD	BSB 35-50 Tuchel 5-pol.	High Flex Leder	7S4FH043020001A11
	8 m	ED/DD	BSB 35-50 Tuchel 5-pol.	High Flex Leder	7S4FH083020001A11
ABITIG® 20	4 m	ED/DD	BSB 35-50 Tuchel 5-pol.	Standard	7S5SK043020001A11
	8 m	ED/DD	BSB 35-50 Tuchel 5-pol.	Standard	7S5SK083020001A11
	4 m	ED/DD	BSB 35-50 Tuchel 5-pol.	High Flex Leder	7S5SH043020001A11
	8 m	ED/DD	BSB 35-50 Tuchel 5-pol.	High Flex Leder	7S5SH083020001A11
ABITIG® 20F	4 m	ED/DD	BSB 35-50 Tuchel 5-pol.	Standard	7S5FK043020001A11
	8 m	ED/DD	BSB 35-50 Tuchel 5-pol.	Standard	7S5FK083020001A11
	4 m	ED/DD	BSB 35-50 Tuchel 5-pol.	High Flex Leder	7S5FH043020001A11
	8 m	ED/DD	BSB 35-50 Tuchel 5-pol.	High Flex Leder	7S5FH083020001A11

Technische Änderungen vorbehalten • Verkaufspreise = unverbindliche Preisempfehlung - Angebot freibleibend • © Copyright

ABITIG®-Brennerpreisliste

passend für WIG-Stromquellen des Fabrikates „nimak“

Brennertyp	Länge	Schalterfunktion	maschinenseitiger Anschluss	Schlauchpaketausführung	Bestellnummer
ABITIG® 12-1	4 m	ED/DD	BSB 35-50 Tuchel 5-pol.	Standard	7S6SK043020001A11
	8 m	ED/DD	BSB 35-50 Tuchel 5-pol.	Standard	7S6SK083020001A11
	4 m	ED/DD	BSB 35-50 Tuchel 5-pol.	High Flex Leder	7S6SH043020001A11
	8 m	ED/DD	BSB 35-50 Tuchel 5-pol.	High Flex Leder	7S6SH083020001A11
ABITIG® 18SC	4 m	ED/DD	BSB 35-50 Tuchel 5-pol.	Standard	7S7SK043020001A11
	8 m	ED/DD	BSB 35-50 Tuchel 5-pol.	Standard	7S7SK083020001A11
	4 m	ED/DD	BSB 35-50 Tuchel 5-pol.	High Flex Leder	7S7SH043020001A11
	8 m	ED/DD	BSB 35-50 Tuchel 5-pol.	High Flex Leder	7S7SH083020001A11
ABITIG® 24W	4 m	ED/DD	BSB 35-50 Tuchel 5-pol.	Standard	7S9SK043020001A11
	8 m	ED/DD	BSB 35-50 Tuchel 5-pol.	Standard	7S9SK083020001A11
	4 m	ED/DD	BSB 35-50 Tuchel 5-pol.	High Flex Leder	7S9SH043020001A11
	8 m	ED/DD	BSB 35-50 Tuchel 5-pol.	High Flex Leder	7S9SH083020001A11
ABITIG® 450W	4 m	ED/DD	BSB 35-50 Tuchel 5-pol.	Standard	7T5SK043020101A11
	8 m	ED/DD	BSB 35-50 Tuchel 5-pol.	Standard	7T5SK083020101A11
	4 m	ED/DD	BSB 35-50 Tuchel 5-pol.	High Flex Leder	7T5SH043020101A11
	8 m	ED/DD	BSB 35-50 Tuchel 5-pol.	High Flex Leder	7T5SH083020101A11
ABITIG® 260W	4 m	ED/DD	BSB 35-50 Tuchel 5-pol.	Standard	7T7SK043020101A11
	8 m	ED/DD	BSB 35-50 Tuchel 5-pol.	Standard	7T7SK083020101A11
	4 m	ED/DD	BSB 35-50 Tuchel 5-pol.	High Flex Leder	7T7SH043020101A11
	8 m	ED/DD	BSB 35-50 Tuchel 5-pol.	High Flex Leder	7T7SH083020101A11
ABITIG® 450W SC	4 m	ED/DD	BSB 35-50 Tuchel 5-pol.	Standard	
	8 m	ED/DD	BSB 35-50 Tuchel 5-pol.	Standard	
	4 m	ED/DD	BSB 35-50 Tuchel 5-pol.	High Flex Leder	7T8SH043020101A11
	8 m	ED/DD	BSB 35-50 Tuchel 5-pol.	High Flex Leder	7T8SH083020101A11

ABITIG®-Brennerpreisliste

passend für WIG-Stromquellen des Fabrikates „nimak“



Brennertyp	Länge	Schalterfunktion	maschinenseitiger Anschluss	Schlauchpaketausführung	Bestellnummer
ABITIG® 18	4 m	ED/DD	ZA - WTW-5	Standard	7S4SK043020498A12
	8 m	ED/DD	ZA - WTW-5	Standard	7S4SK083020498A12
	4 m	ED/DD	ZA - WTW-5	High Flex Leder	7S4SH043020498A12
	8 m	ED/DD	ZA - WTW-5	High Flex Leder	7S4SH083020498A12

ABITIG® 18F	4 m	ED/DD	ZA - WTW-5	Standard	7S4FK043020498A12
	8 m	ED/DD	ZA - WTW-5	Standard	7S4FK083020498A12
	4 m	ED/DD	ZA - WTW-5	High Flex Leder	7S4FH043020498A12
	8 m	ED/DD	ZA - WTW-5	High Flex Leder	7S4FH083020498A12

ABITIG® 20	4 m	ED/DD	ZA - WTW-5	Standard	7S5SK043020498A12
	8 m	ED/DD	ZA - WTW-5	Standard	7S5SK083020498A12
	4 m	ED/DD	ZA - WTW-5	High Flex Leder	7S5SH043020498A12
	8 m	ED/DD	ZA - WTW-5	High Flex Leder	7S5SH083020498A12

ABITIG® 20F	4 m	ED/DD	ZA - WTW-5	Standard	7S5FK043020498A12
	8 m	ED/DD	ZA - WTW-5	Standard	7S5FK083020498A12
	4 m	ED/DD	ZA - WTW-5	High Flex Leder	7S5FH043020498A12
	8 m	ED/DD	ZA - WTW-5	High Flex Leder	7S5FH083020498A12

Technische Änderungen vorbehalten • Verkaufspreise = unverbindliche Preisempfehlung - Angebot freibleibend • © Copyright

ABITIG®-Brennerpreisliste

passend für WIG-Stromquellen des Fabrikates „nimak“

Brennertyp	Länge	Schalterfunktion	maschinenseitiger Anschluss	Schlauchpaketausführung	Bestellnummer
ABITIG® 12-1	4 m	ED/DD	ZA - WTW-5	Standard	7S6SK043020498A12
	8 m	ED/DD	ZA - WTW-5	Standard	7S6SK083020498A12
	4 m	ED/DD	ZA - WTW-5	High Flex Leder	7S6SH043020498A12
	8 m	ED/DD	ZA - WTW-5	High Flex Leder	7S6SH083020498A12
ABITIG® 18SC	4 m	ED/DD	ZA - WTW-5	Standard	7S7SK043020498A12
	8 m	ED/DD	ZA - WTW-5	Standard	7S7SK083020498A12
	4 m	ED/DD	ZA - WTW-5	High Flex Leder	7S7SH043020498A12
	8 m	ED/DD	ZA - WTW-5	High Flex Leder	7S7SH083020498A12
ABITIG® 24W	4 m	ED/DD	ZA - WTW-5	Standard	7S9SK043020498A12
	8 m	ED/DD	ZA - WTW-5	Standard	7S9SK083020498A12
	4 m	ED/DD	ZA - WTW-5	High Flex Leder	7S9SH043020498A12
	8 m	ED/DD	ZA - WTW-5	High Flex Leder	7S9SH083020498A12
ABITIG® 450W	4 m	ED/DD	ZA - WTW-5	Standard	7T5SK043020498A12
	8 m	ED/DD	ZA - WTW-5	Standard	7T5SK083020498A12
	4 m	ED/DD	ZA - WTW-5	High Flex Leder	7T5SH043020498A12
	8 m	ED/DD	ZA - WTW-5	High Flex Leder	7T5SH083020498A12
ABITIG® 260W	4 m	ED/DD	ZA - WTW-5	Standard	7T7SK043020498A12
	8 m	ED/DD	ZA - WTW-5	Standard	7T7SK083020498A12
	4 m	ED/DD	ZA - WTW-5	High Flex Leder	7T7SH043020498A12
	8 m	ED/DD	ZA - WTW-5	High Flex Leder	7T7SH083020498A12
ABITIG® 450W SC	4 m	ED/DD	ZA - WTW-5	Standard	
	8 m	ED/DD	ZA - WTW-5	Standard	
	4 m	ED/DD	ZA - WTW-5	High Flex Leder	7T8SH043020498A12
	8 m	ED/DD	ZA - WTW-5	High Flex Leder	7T8SH083020498A12

ABITIG®-Brennerpreisliste

passend für WIG-Stromquellen des Fabrikates „oerlikon“



Brennertyp	Länge	Schalterfunktion	maschinenseitiger Anschluss	Schlauchpaketausführung	Bestellnummer
ABITIG® 9	4 m	DD	oerlikon - ZA Tuchel 5-pol.	Standard	7S1SK043021822A00
	8 m	DD	oerlikon - ZA Tuchel 5-pol.	Standard	7S1SK083021822A00
	4 m	DD	oerlikon - ZA Tuchel 5-pol.	High Flex Leder	7S1SH043021822A00
	8 m	DD	oerlikon - ZA Tuchel 5-pol.	High Flex Leder	7S1SH083021822A00
ABITIG® 9F	4 m	DD	oerlikon - ZA Tuchel 5-pol.	Standard	7S1FK043021822A00
	8 m	DD	oerlikon - ZA Tuchel 5-pol.	Standard	7S1FK083021822A00
	4 m	DD	oerlikon - ZA Tuchel 5-pol.	High Flex Leder	7S1FH043021822A00
	8 m	DD	oerlikon - ZA Tuchel 5-pol.	High Flex Leder	7S1FH083021822A00
ABITIG® 17	4 m	DD	oerlikon - ZA Tuchel 5-pol.	Standard	7S2SK043021822A00
	8 m	DD	oerlikon - ZA Tuchel 5-pol.	Standard	7S2SK083021822A00
	4 m	DD	oerlikon - ZA Tuchel 5-pol.	High Flex Leder	7S2SH043021822A00
	8 m	DD	oerlikon - ZA Tuchel 5-pol.	High Flex Leder	7S2SH083021822A00
ABITIG® 17F	4 m	DD	oerlikon - ZA Tuchel 5-pol.	Standard	7S2FK043021822A00
	8 m	DD	oerlikon - ZA Tuchel 5-pol.	Standard	7S2FK083021822A00
	4 m	DD	oerlikon - ZA Tuchel 5-pol.	High Flex Leder	7S2FH043021822A00
	8 m	DD	oerlikon - ZA Tuchel 5-pol.	High Flex Leder	7S2FH083021822A00

Technische Änderungen vorbehalten • Verkaufspreise = unverbindliche Preisempfehlung - Angebot freibleibend • © Copyright

ABITIG®-Brennerpreisliste

passend für WIG-Stromquellen des Fabrikates „oerlikon“

Brennertyp	Länge	Schalterfunktion	maschinenseitiger Anschluss	Schlauchpaketausführung	Bestellnummer
ABITIG® 26	4 m	DD	oerlikon - ZA Tuchel 5-pol.	Standard	7S3SK043021822A00
	8 m	DD	oerlikon - ZA Tuchel 5-pol.	Standard	7S3SK083021822A00
	4 m	DD	oerlikon - ZA Tuchel 5-pol.	High Flex Leder	7S3SH043021822A00
	8 m	DD	oerlikon - ZA Tuchel 5-pol.	High Flex Leder	7S3SH083021822A00

ABITIG® 26F	4 m	DD	oerlikon - ZA Tuchel 5-pol.	Standard	7S3FK043021822A00
	8 m	DD	oerlikon - ZA Tuchel 5-pol.	Standard	7S3FK083021822A00
	4 m	DD	oerlikon - ZA Tuchel 5-pol.	High Flex Leder	7S3FH043021822A00
	8 m	DD	oerlikon - ZA Tuchel 5-pol.	High Flex Leder	7S3FH083021822A00

ABITIG® 24G	4 m	DD	oerlikon - ZA Tuchel 5-pol.	Standard	7S8SK043021822A00
	8 m	DD	oerlikon - ZA Tuchel 5-pol.	Standard	7S8SK083021822A00
	4 m	DD	oerlikon - ZA Tuchel 5-pol.	High Flex Leder	7S8SH043021822A00
	8 m	DD	oerlikon - ZA Tuchel 5-pol.	High Flex Leder	7S8SH083021822A00

ABITIG® 200	4 m	DD	oerlikon - ZA Tuchel 5-pol.	Standard	7T4SK043021822A00
	8 m	DD	oerlikon - ZA Tuchel 5-pol.	Standard	7T4SK083021822A00
	4 m	DD	oerlikon - ZA Tuchel 5-pol.	High Flex Leder	7T4SH043021822A00
	8 m	DD	oerlikon - ZA Tuchel 5-pol.	High Flex Leder	7T4SH083021822A00

ABITIG® 200F	4 m	DD	oerlikon - ZA Tuchel 5-pol.	Standard	7T4FK043021822A00
	8 m	DD	oerlikon - ZA Tuchel 5-pol.	Standard	7T4FK083021822A00
	4 m	DD	oerlikon - ZA Tuchel 5-pol.	High Flex Leder	7T4FH043021822A00
	8 m	DD	oerlikon - ZA Tuchel 5-pol.	High Flex Leder	7T4FH083021822A00

ABITIG® 150	4 m	DD	oerlikon - ZA Tuchel 5-pol.	Standard	7T6SK043021822A00
	8 m	DD	oerlikon - ZA Tuchel 5-pol.	Standard	7T6SK083021822A00
	4 m	DD	oerlikon - ZA Tuchel 5-pol.	High Flex Leder	7T6SH043021822A00
	8 m	DD	oerlikon - ZA Tuchel 5-pol.	High Flex Leder	7T6SH083021822A00

ABITIG® 150F	4 m	DD	oerlikon - ZA Tuchel 5-pol.	Standard	7T6FK043021822A00
	8 m	DD	oerlikon - ZA Tuchel 5-pol.	Standard	7T6FK083021822A00
	4 m	DD	oerlikon - ZA Tuchel 5-pol.	High Flex Leder	7T6FH043021822A00
	8 m	DD	oerlikon - ZA Tuchel 5-pol.	High Flex Leder	7T6FH083021822A00

ABITIG®-Brennerpreisliste

passend für WIG-Stromquellen des Fabrikates „oerlikon“ Prestotig



Brennertyp	Länge	Schalterfunktion	maschinenseitiger Anschluss	Schlauchpaketausführung	Bestellnummer
ABITIG® 9	4 m	DD	oerlikon - BSB / CG Tuchel 5-pol.	Standard	7S1SK043022522A00
	8 m	DD	oerlikon - BSB / CG Tuchel 5-pol.	Standard	7S1SK083022522A00
	4 m	DD	oerlikon - BSB / CG Tuchel 5-pol.	High Flex Leder	7S1SH043022522A00
	8 m	DD	oerlikon - BSB / CG Tuchel 5-pol.	High Flex Leder	7S1SH083022522A00
ABITIG® 9F	4 m	DD	oerlikon - BSB / CG Tuchel 5-pol.	Standard	7S1FK043022522A00
	8 m	DD	oerlikon - BSB / CG Tuchel 5-pol.	Standard	7S1FK083022522A00
	4 m	DD	oerlikon - BSB / CG Tuchel 5-pol.	High Flex Leder	7S1FH043022522A00
	8 m	DD	oerlikon - BSB / CG Tuchel 5-pol.	High Flex Leder	7S1FH083022522A00
ABITIG® 17	4 m	DD	oerlikon - BSB / CG Tuchel 5-pol.	Standard	7S2SK043022522A00
	8 m	DD	oerlikon - BSB / CG Tuchel 5-pol.	Standard	7S2SK083022522A00
	4 m	DD	oerlikon - BSB / CG Tuchel 5-pol.	High Flex Leder	7S2SH043022522A00
	8 m	DD	oerlikon - BSB / CG Tuchel 5-pol.	High Flex Leder	7S2SH083022522A00
ABITIG® 17F	4 m	DD	oerlikon - BSB / CG Tuchel 5-pol.	Standard	7S2FK043022522A00
	8 m	DD	oerlikon - BSB / CG Tuchel 5-pol.	Standard	7S2FK083022522A00
	4 m	DD	oerlikon - BSB / CG Tuchel 5-pol.	High Flex Leder	7S2FH043022522A00
	8 m	DD	oerlikon - BSB / CG Tuchel 5-pol.	High Flex Leder	7S2FH083022522A00

Technische Änderungen vorbehalten • Verkaufspreise = unverbindliche Preisempfehlung - Angebot freibleibend • © Copyright

ABITIG®-Brennerpreisliste

passend für WIG-Stromquellen des Fabrikates „oerlikon“ Prestotig

Brennertyp	Länge	Schalterfunktion	maschinenseitiger Anschluss	Schlauchpaketausführung	Bestellnummer
ABITIG® 26	4 m	DD	oerlikon - BSB / CG Tuchel 5-pol.	Standard	7S3SK043022522A00
	8 m	DD	oerlikon - BSB / CG Tuchel 5-pol.	Standard	7S3SK083022522A00
	4 m	DD	oerlikon - BSB / CG Tuchel 5-pol.	High Flex Leder	7S3SH043022522A00
	8 m	DD	oerlikon - BSB / CG Tuchel 5-pol.	High Flex Leder	7S3SH083022522A00
ABITIG® 26F	4 m	DD	oerlikon - BSB / CG Tuchel 5-pol.	Standard	7S3FK043022522A00
	8 m	DD	oerlikon - BSB / CG Tuchel 5-pol.	Standard	7S3FK083022522A00
	4 m	DD	oerlikon - BSB / CG Tuchel 5-pol.	High Flex Leder	7S3FH043022522A00
	8 m	DD	oerlikon - BSB / CG Tuchel 5-pol.	High Flex Leder	7S3FH083022522A00
ABITIG® 24G	4 m	DD	oerlikon - BSB / CG Tuchel 5-pol.	Standard	7S8SK043022522A00
	8 m	DD	oerlikon - BSB / CG Tuchel 5-pol.	Standard	7S8SK083022522A00
	4 m	DD	oerlikon - BSB / CG Tuchel 5-pol.	High Flex Leder	7S8SH043022522A00
	8 m	DD	oerlikon - BSB / CG Tuchel 5-pol.	High Flex Leder	7S8SH083022522A00
ABITIG® 200	4 m	DD	oerlikon - BSB / CG Tuchel 5-pol.	Standard	7T4SK043022522A00
	8 m	DD	oerlikon - BSB / CG Tuchel 5-pol.	Standard	7T4SK083022522A00
	4 m	DD	oerlikon - BSB / CG Tuchel 5-pol.	High Flex Leder	7T4SH043022522A00
	8 m	DD	oerlikon - BSB / CG Tuchel 5-pol.	High Flex Leder	7T4SH083022522A00
ABITIG® 200F	4 m	DD	oerlikon - BSB / CG Tuchel 5-pol.	Standard	7T4FK043022522A00
	8 m	DD	oerlikon - BSB / CG Tuchel 5-pol.	Standard	7T4FK083022522A00
	4 m	DD	oerlikon - BSB / CG Tuchel 5-pol.	High Flex Leder	7T4FH043022522A00
	8 m	DD	oerlikon - BSB / CG Tuchel 5-pol.	High Flex Leder	7T4FH083022522A00
ABITIG® 150	4 m	DD	oerlikon - BSB / CG Tuchel 5-pol.	Standard	7T6SK043022522A00
	8 m	DD	oerlikon - BSB / CG Tuchel 5-pol.	Standard	7T6SK083022522A00
	4 m	DD	oerlikon - BSB / CG Tuchel 5-pol.	High Flex Leder	7T6SH043022522A00
	8 m	DD	oerlikon - BSB / CG Tuchel 5-pol.	High Flex Leder	7T6SH083022522A00
ABITIG® 150F	4 m	DD	oerlikon - BSB / CG Tuchel 5-pol.	Standard	7T6FK043022522A00
	8 m	DD	oerlikon - BSB / CG Tuchel 5-pol.	Standard	7T6FK083022522A00
	4 m	DD	oerlikon - BSB / CG Tuchel 5-pol.	High Flex Leder	7T6FH043022522A00
	8 m	DD	oerlikon - BSB / CG Tuchel 5-pol.	High Flex Leder	7T6FH083022522A00

ABITIG®-Brennerpreisliste

passend für WIG-Stromquellen des Fabrikates „oerlikon“ ZA flüssiggekühlt



Brennertyp	Länge	Schalterfunktion	maschinenseitiger Anschluss	Schlauchpaketausführung	Bestellnummer
ABITIG® 18	4 m	DD	oerlikon - ZA Tuchel 5-pol.	Standard	7S4SK043021904A00
	8 m	DD	oerlikon - ZA Tuchel 5-pol.	Standard	7S4SK083021904A00
	4 m	DD	oerlikon - ZA Tuchel 5-pol.	High Flex Leder	7S4SH043021904A00
	8 m	DD	oerlikon - ZA Tuchel 5-pol.	High Flex Leder	7S4SH083021904A00

ABITIG® 18F	4 m	DD	oerlikon - ZA Tuchel 5-pol.	Standard	7S4FK043021904A00
	8 m	DD	oerlikon - ZA Tuchel 5-pol.	Standard	7S4FK083021904A00
	4 m	DD	oerlikon - ZA Tuchel 5-pol.	High Flex Leder	7S4FH043021904A00
	8 m	DD	oerlikon - ZA Tuchel 5-pol.	High Flex Leder	7S4FH083021904A-00

ABITIG® 20	4 m	DD	oerlikon - ZA Tuchel 5-pol.	Standard	7S5SK043021904A00
	8 m	DD	oerlikon - ZA Tuchel 5-pol.	Standard	7S5SK083021904A00
	4 m	DD	oerlikon - ZA Tuchel 5-pol.	High Flex Leder	7S5SH043021904A00
	8 m	DD	oerlikon - ZA Tuchel 5-pol.	High Flex Leder	7S5SH083021904A00

ABITIG® 20F	4 m	DD	oerlikon - ZA Tuchel 5-pol.	Standard	7S5FK043021904A00
	8 m	DD	oerlikon - ZA Tuchel 5-pol.	Standard	7S5FK083021904A00
	4 m	DD	oerlikon - ZA Tuchel 5-pol.	High Flex Leder	7S5FH043021904A00
	8 m	DD	oerlikon - ZA Tuchel 5-pol.	High Flex Leder	7S5FH083021904A00

Technische Änderungen vorbehalten • Verkaufspreise = unverbindliche Preisempfehlung - Angebot freibleibend • © Copyright

ABITIG®-Brennerpreisliste

passend für WIG-Stromquellen des Fabrikates „oerlikon“ ZA flüssiggekühlt

Brennertyp	Länge	Schalterfunktion	maschinenseitiger Anschluss	Schlauchpaketausführung	Bestellnummer
ABITIG® 12-1	4 m	DD	oerlikon - ZA Tuchel 5-pol.	Standard	7S6SK043021904A00
	8 m	DD	oerlikon - ZA Tuchel 5-pol.	Standard	7S6SK083021904A00
	4 m	DD	oerlikon - ZA Tuchel 5-pol.	High Flex Leder	7S6SH043021904A00
	8 m	DD	oerlikon - ZA Tuchel 5-pol.	High Flex Leder	7S6SH083021904A00
<hr/>					
ABITIG® 18SC	4 m	DD	oerlikon - ZA Tuchel 5-pol.	Standard	7S7SK043021904A00
	8 m	DD	oerlikon - ZA Tuchel 5-pol.	Standard	7S7SK083021904A00
	4 m	DD	oerlikon - ZA Tuchel 5-pol.	High Flex Leder	7S7SH043021904A00
	8 m	DD	oerlikon - ZA Tuchel 5-pol.	High Flex Leder	7S7SH083021904A00
<hr/>					
ABITIG® 24W	4 m	DD	oerlikon - ZA Tuchel 5-pol.	Standard	7S9SK043021904A00
	8 m	DD	oerlikon - ZA Tuchel 5-pol.	Standard	7S9SK083021904A00
	4 m	DD	oerlikon - ZA Tuchel 5-pol.	High Flex Leder	7S9SH043021904A00
	8 m	DD	oerlikon - ZA Tuchel 5-pol.	High Flex Leder	7S9SH083021904A00
<hr/>					
ABITIG® 450W	4 m	DD	oerlikon - ZA Tuchel 5-pol.	Standard	7T5SK043021904A00
	8 m	DD	oerlikon - ZA Tuchel 5-pol.	Standard	7T5SK083021904A00
	4 m	DD	oerlikon - ZA Tuchel 5-pol.	High Flex Leder	7T5SH043021904A00
	8 m	DD	oerlikon - ZA Tuchel 5-pol.	High Flex Leder	7T5SH083021904A00
<hr/>					
ABITIG® 260W	4 m	DD	oerlikon - ZA Tuchel 5-pol.	Standard	7T7SK043021904A00
	8 m	DD	oerlikon - ZA Tuchel 5-pol.	Standard	7T7SK083021904A00
	4 m	DD	oerlikon - ZA Tuchel 5-pol.	High Flex Leder	7T7SH043021904A00
	8 m	DD	oerlikon - ZA Tuchel 5-pol.	High Flex Leder	7T7SH083021904A00
<hr/>					
ABITIG® 450W SC	4 m	DD	oerlikon - ZA Tuchel 5-pol.	Standard	
	8 m	DD	oerlikon - ZA Tuchel 5-pol.	Standard	
	4 m	DD	oerlikon - ZA Tuchel 5-pol.	High Flex Leder	7T8SH043021904A00
	8 m	DD	oerlikon - ZA Tuchel 5-pol.	High Flex Leder	7T8SH083021904A00

ABITIG®-Brennerpreisliste

passend für WIG-Stromquellen des Fabrikates „oerlikon“ Prestotig



Brennertyp	Länge	Schalterfunktion	maschinenseitiger Anschluss	Schlauchpaketausführung	Bestellnummer
ABITIG® 18	4 m	DD	oerlikon - BSB / CG Tuchel 5-pol.	Standard	7S4SK043022504A12
	8 m	DD	oerlikon - BSB / CG Tuchel 5-pol.	Standard	7S4SK083022504A12
	4 m	DD	oerlikon - BSB / CG Tuchel 5-pol.	High Flex Leder	7S4SH043022504A12
	8 m	DD	oerlikon - BSB / CG Tuchel 5-pol.	High Flex Leder	7S4SH083022504A12
ABITIG® 18F	4 m	DD	oerlikon - BSB / CG Tuchel 5-pol.	Standard	7S4FK043022504A12
	8 m	DD	oerlikon - BSB / CG Tuchel 5-pol.	Standard	7S4FK083022504A12
	4 m	DD	oerlikon - BSB / CG Tuchel 5-pol.	High Flex Leder	7S4FH043022504A12
	8 m	DD	oerlikon - BSB / CG Tuchel 5-pol.	High Flex Leder	7S4FH083022504A12
ABITIG® 20	4 m	DD	oerlikon - BSB / CG Tuchel 5-pol.	Standard	7S5SK043022504A12
	8 m	DD	oerlikon - BSB / CG Tuchel 5-pol.	Standard	7S5SK083022504A12
	4 m	DD	oerlikon - BSB / CG Tuchel 5-pol.	High Flex Leder	7S5SH043022504A12
	8 m	DD	oerlikon - BSB / CG Tuchel 5-pol.	High Flex Leder	7S5SH083022504A12
ABITIG® 20F	4 m	DD	oerlikon - BSB / CG Tuchel 5-pol.	Standard	7S5FK043022504A12
	8 m	DD	oerlikon - BSB / CG Tuchel 5-pol.	Standard	7S5FK083022504A12
	4 m	DD	oerlikon - BSB / CG Tuchel 5-pol.	High Flex Leder	7S5FH043022504A12
	8 m	DD	oerlikon - BSB / CG Tuchel 5-pol.	High Flex Leder	7S5FH083022504A12

Technische Änderungen vorbehalten • Verkaufspreise = unverbindliche Preisempfehlung - Angebot freibleibend • © Copyright

ABITIG®-Brennerpreisliste

passend für WIG-Stromquellen des Fabrikates „oerlikon“ Prestotig

Brennertyp	Länge	Schalterfunktion	maschinenseitiger Anschluss	Schlauchpaketausführung	Bestellnummer
ABITIG® 12-1	4 m	DD	oerlikon - BSB / CG Tuchel 5-pol.	Standard	7S6SK043022504A12
	8 m	DD	oerlikon - BSB / CG Tuchel 5-pol.	Standard	7S6SK083022504A12
	4 m	DD	oerlikon - BSB / CG Tuchel 5-pol.	High Flex Leder	7S6SH043022504A12
	8 m	DD	oerlikon - BSB / CG Tuchel 5-pol.	High Flex Leder	7S6SH083022504A12
ABITIG® 18SC	4 m	DD	oerlikon - BSB / CG Tuchel 5-pol.	Standard	7S7SK043022504A12
	8 m	DD	oerlikon - BSB / CG Tuchel 5-pol.	Standard	7S7SK083022504A12
	4 m	DD	oerlikon - BSB / CG Tuchel 5-pol.	High Flex Leder	7S7SH043022504A12
	8 m	DD	oerlikon - BSB / CG Tuchel 5-pol.	High Flex Leder	7S7SH083022504A12
ABITIG® 24W	4 m	DD	oerlikon - BSB / CG Tuchel 5-pol.	Standard	7S9SK043022504A12
	8 m	DD	oerlikon - BSB / CG Tuchel 5-pol.	Standard	7S9SK083022504A12
	4 m	DD	oerlikon - BSB / CG Tuchel 5-pol.	High Flex Leder	7S9SH043022504A12
	8 m	DD	oerlikon - BSB / CG Tuchel 5-pol.	High Flex Leder	7S9SH083022504A12
ABITIG® 450W	4 m	DD	oerlikon - BSB / CG Tuchel 5-pol.	Standard	7T5SK043022504A12
	8 m	DD	oerlikon - BSB / CG Tuchel 5-pol.	Standard	7T5SK083022504A12
	4 m	DD	oerlikon - BSB / CG Tuchel 5-pol.	High Flex Leder	7T5SH043022504A12
	8 m	DD	oerlikon - BSB / CG Tuchel 5-pol.	High Flex Leder	7T5SH083022504A12
ABITIG® 260W	4 m	DD	oerlikon - BSB / CG Tuchel 5-pol.	Standard	7T7SK043022504A12
	8 m	DD	oerlikon - BSB / CG Tuchel 5-pol.	Standard	7T7SK083022504A12
	4 m	DD	oerlikon - BSB / CG Tuchel 5-pol.	High Flex Leder	7T7SH043022504A12
	8 m	DD	oerlikon - BSB / CG Tuchel 5-pol.	High Flex Leder	7T7SH083022504A12
ABITIG® 450W SC	4 m	DD	oerlikon - BSB / CG Tuchel 5-pol.	Standard	
	8 m	DD	oerlikon - BSB / CG Tuchel 5-pol.	Standard	
	4 m	DD	oerlikon - BSB / CG Tuchel 5-pol.	High Flex Leder	7T8SH043022504A12
	8 m	DD	oerlikon - BSB / CG Tuchel 5-pol.	High Flex Leder	7T8SH083022504A12

ABITIG®-Brennerpreisliste

passend für WIG-Stromquellen des Fabrikates „pego“

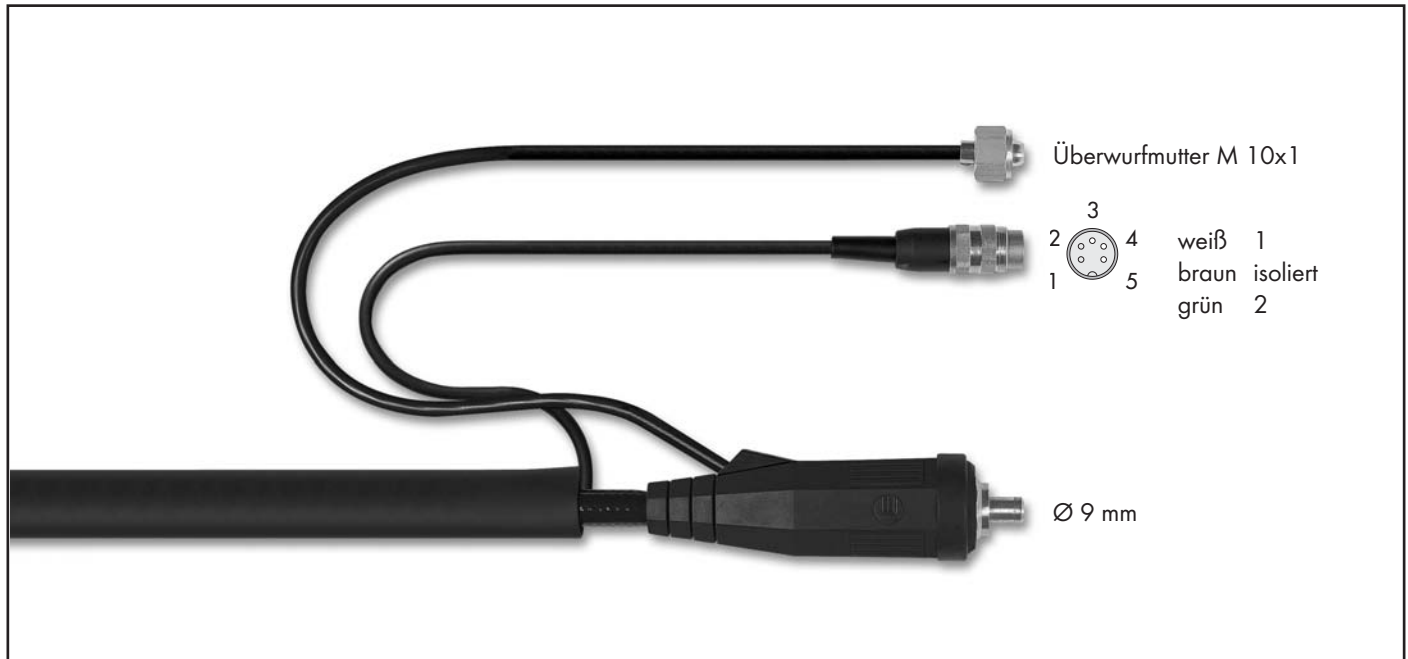

Brennertyp	Länge	Schalterfunktion	maschinenseitiger Anschluss	Schlauchpaketausführung	Bestellnummer
ABITIG® 9	4 m	ED	BSB 10-25 Rundsteckverb. 5-pol.	Standard	7S1SK043012235A54
	8 m	ED	BSB 10-25 Rundsteckverb. 5-pol.	Standard	7S1SK083012235A54
	4 m	ED	BSB 10-25 Rundsteckverb. 5-pol.	High Flex Leder	7S1SH043012235A54
	8 m	ED	BSB 10-25 Rundsteckverb. 5-pol.	High Flex Leder	7S1SH083012235A54

ABITIG® 9F	4 m	ED	BSB 10-25 Rundsteckverb. 5-pol.	Standard	7S1FK043012235A54
	8 m	ED	BSB 10-25 Rundsteckverb. 5-pol.	Standard	7S1FK083012235A54
	4 m	ED	BSB 10-25 Rundsteckverb. 5-pol.	High Flex Leder	7S1FH043012235A54
	8 m	ED	BSB 10-25 Rundsteckverb. 5-pol.	High Flex Leder	7S1FH083012235A54

ABITIG® 17	4 m	ED	BSB 10-25 Rundsteckverb. 5-pol.	Standard	7S2SK043012235A54
	8 m	ED	BSB 10-25 Rundsteckverb. 5-pol.	Standard	7S2SK083012235A54
	4 m	ED	BSB 10-25 Rundsteckverb. 5-pol.	High Flex Leder	7S2SH043012235A54
	8 m	ED	BSB 10-25 Rundsteckverb. 5-pol.	High Flex Leder	7S2SH083012235A54

ABITIG® 17F	4 m	ED	BSB 10-25 Rundsteckverb. 5-pol.	Standard	7S2FK043012235A54
	8 m	ED	BSB 10-25 Rundsteckverb. 5-pol.	Standard	7S2FK083012235A54
	4 m	ED	BSB 10-25 Rundsteckverb. 5-pol.	High Flex Leder	7S2FH043012235A54
	8 m	ED	BSB 10-25 Rundsteckverb. 5-pol.	High Flex Leder	7S2FH083012235A54

Technische Änderungen vorbehalten • Verkaufspreise = unverbindliche Preisempfehlung - Angebot freibleibend • © Copyright

ABITIG®-Brennerpreisliste

passend für WIG-Stromquellen des Fabrikates „pego“

Brennertyp	Länge	Schalterfunktion	maschinenseitiger Anschluss	Schlauchpaketausführung	Bestellnummer
ABITIG® 26	4 m	ED	BSB 10-25 Rundsteckverb. 5-pol.	Standard	7S3SK043012235A54
	8 m	ED	BSB 10-25 Rundsteckverb. 5-pol.	Standard	7S3SK083012235A54
	4 m	ED	BSB 10-25 Rundsteckverb. 5-pol.	High Flex Leder	7S3SH043012235A54
	8 m	ED	BSB 10-25 Rundsteckverb. 5-pol.	High Flex Leder	7S3SH083012235A54
ABITIG® 26F	4 m	ED	BSB 10-25 Rundsteckverb. 5-pol.	Standard	7S3FK043012235A54
	8 m	ED	BSB 10-25 Rundsteckverb. 5-pol.	Standard	7S3FK083012235A54
	4 m	ED	BSB 10-25 Rundsteckverb. 5-pol.	High Flex Leder	7S3FH043012235A54
	8 m	ED	BSB 10-25 Rundsteckverb. 5-pol.	High Flex Leder	7S3FH083012235A54
ABITIG® 24G	4 m	ED	BSB 10-25 Rundsteckverb. 5-pol.	Standard	7S8SK043012235A54
	8 m	ED	BSB 10-25 Rundsteckverb. 5-pol.	Standard	7S8SK083012235A54
	4 m	ED	BSB 10-25 Rundsteckverb. 5-pol.	High Flex Leder	7S8SH043012235A54
	8 m	ED	BSB 10-25 Rundsteckverb. 5-pol.	High Flex Leder	7S8SH083012235A54
ABITIG® 200	4 m	ED	BSB 10-25 Rundsteckverb. 5-pol.	Standard	7T4SK043012235A54
	8 m	ED	BSB 10-25 Rundsteckverb. 5-pol.	Standard	7T4SK083012235A54
	4 m	ED	BSB 10-25 Rundsteckverb. 5-pol.	High Flex Leder	7T4SH043012235A54
	8 m	ED	BSB 10-25 Rundsteckverb. 5-pol.	High Flex Leder	7T4SH083012235A54
ABITIG® 200F	4 m	ED	BSB 10-25 Rundsteckverb. 5-pol.	Standard	7T4FK043012235A54
	8 m	ED	BSB 10-25 Rundsteckverb. 5-pol.	Standard	7T4FK083012235A54
	4 m	ED	BSB 10-25 Rundsteckverb. 5-pol.	High Flex Leder	7T4FH043012235A54
	8 m	ED	BSB 10-25 Rundsteckverb. 5-pol.	High Flex Leder	7T4FH083012235A54
ABITIG® 150	4 m	ED	BSB 10-25 Rundsteckverb. 5-pol.	Standard	7T6SK043012235A54
	8 m	ED	BSB 10-25 Rundsteckverb. 5-pol.	Standard	7T6SK083012235A54
	4 m	ED	BSB 10-25 Rundsteckverb. 5-pol.	High Flex Leder	7T6SH043012235A54
	8 m	ED	BSB 10-25 Rundsteckverb. 5-pol.	High Flex Leder	7T6SH083012235A54
ABITIG® 150F	4 m	ED	BSB 10-25 Rundsteckverb. 5-pol.	Standard	7T6FK043012235A54
	8 m	ED	BSB 10-25 Rundsteckverb. 5-pol.	Standard	7T6FK083012235A54
	4 m	ED	BSB 10-25 Rundsteckverb. 5-pol.	High Flex Leder	7T6FH043012235A54
	8 m	ED	BSB 10-25 Rundsteckverb. 5-pol.	High Flex Leder	7T6FH083012235A54

ABITIG®-Brennerpreisliste

passend für WIG-Stromquellen des Fabrikates „pego“

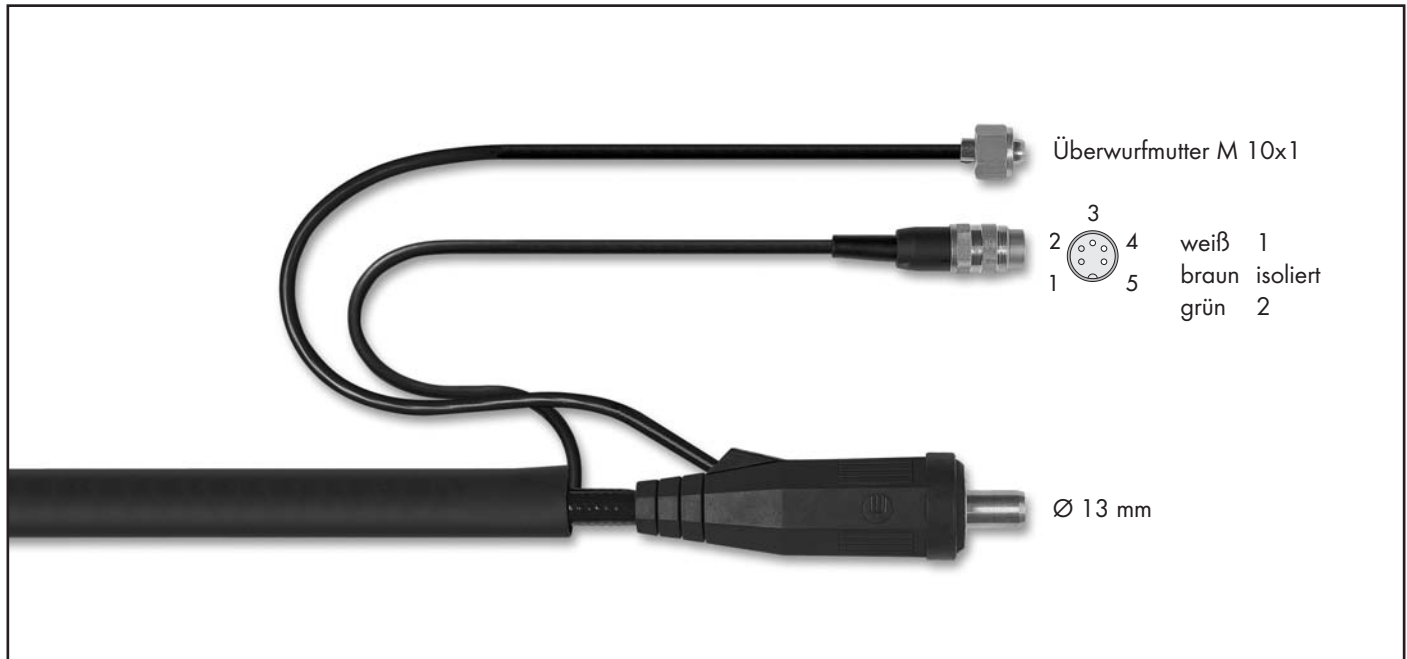

Brennertyp	Länge	Schalterfunktion	maschinenseitiger Anschluss	Schlauchpaketausführung	Bestellnummer
ABITIG® 9	4 m	ED	BSB 35-50 Rundsteckverb. 5-pol.	Standard	7S1SK043010035A54
	8 m	ED	BSB 35-50 Rundsteckverb. 5-pol.	Standard	7S1SK083010035A54
	4 m	ED	BSB 35-50 Rundsteckverb. 5-pol.	High Flex Leder	7S1SH043010035A54
	8 m	ED	BSB 35-50 Rundsteckverb. 5-pol.	High Flex Leder	7S1SH083010035A54
ABITIG® 9F	4 m	ED	BSB 35-50 Rundsteckverb. 5-pol.	Standard	7S1FK043010035A54
	8 m	ED	BSB 35-50 Rundsteckverb. 5-pol.	Standard	7S1FK083010035A54
	4 m	ED	BSB 35-50 Rundsteckverb. 5-pol.	High Flex Leder	7S1FH043010035A54
	8 m	ED	BSB 35-50 Rundsteckverb. 5-pol.	High Flex Leder	7S1FH083010035A54
ABITIG® 17	4 m	ED	BSB 35-50 Rundsteckverb. 5-pol.	Standard	7S2SK043010035A54
	8 m	ED	BSB 35-50 Rundsteckverb. 5-pol.	Standard	7S2SK083010035A54
	4 m	ED	BSB 35-50 Rundsteckverb. 5-pol.	High Flex Leder	7S2SH043010035A54
	8 m	ED	BSB 35-50 Rundsteckverb. 5-pol.	High Flex Leder	7S2SH083010035A54
ABITIG® 17F	4 m	ED	BSB 35-50 Rundsteckverb. 5-pol.	Standard	7S2FK043010035A54
	8 m	ED	BSB 35-50 Rundsteckverb. 5-pol.	Standard	7S2FK083010035A54
	4 m	ED	BSB 35-50 Rundsteckverb. 5-pol.	High Flex Leder	7S2FH043010035A54
	8 m	ED	BSB 35-50 Rundsteckverb. 5-pol.	High Flex Leder	7S2FH083010035A54

Technische Änderungen vorbehalten • Verkaufspreise = unverbindliche Preisempfehlung - Angebot freibleibend • © Copyright

ABITIG®-Brennerpreisliste

passend für WIG-Stromquellen des Fabrikates „pego“

Brennertyp	Länge	Schalterfunktion	maschinenseitiger Anschluss	Schlauchpaketausführung	Bestellnummer
ABITIG® 26	4 m	ED	BSB 35-50 Rundsteckverb. 5-pol.	Standard	7S3SK043010035A54
	8 m	ED	BSB 35-50 Rundsteckverb. 5-pol.	Standard	7S3SK083010035A54
	4 m	ED	BSB 35-50 Rundsteckverb. 5-pol.	High Flex Leder	7S3SH043010035A54
	8 m	ED	BSB 35-50 Rundsteckverb. 5-pol.	High Flex Leder	7S3SH083010035A54
ABITIG® 26F	4 m	ED	BSB 35-50 Rundsteckverb. 5-pol.	Standard	7S3FK043010035A54
	8 m	ED	BSB 35-50 Rundsteckverb. 5-pol.	Standard	7S3FK083010035A54
	4 m	ED	BSB 35-50 Rundsteckverb. 5-pol.	High Flex Leder	7S3FH043010035A54
	8 m	ED	BSB 35-50 Rundsteckverb. 5-pol.	High Flex Leder	7S3FH083010035A54
ABITIG® 24G	4 m	ED	BSB 35-50 Rundsteckverb. 5-pol.	Standard	7S8SK043010035A54
	8 m	ED	BSB 35-50 Rundsteckverb. 5-pol.	Standard	7S8SK083010035A54
	4 m	ED	BSB 35-50 Rundsteckverb. 5-pol.	High Flex Leder	7S8SH043010035A54
	8 m	ED	BSB 35-50 Rundsteckverb. 5-pol.	High Flex Leder	7S8SH083010035A54
ABITIG® 200	4 m	ED	BSB 35-50 Rundsteckverb. 5-pol.	Standard	7T4SK043010035A54
	8 m	ED	BSB 35-50 Rundsteckverb. 5-pol.	Standard	7T4SK083010035A54
	4 m	ED	BSB 35-50 Rundsteckverb. 5-pol.	High Flex Leder	7T4SH043010035A54
	8 m	ED	BSB 35-50 Rundsteckverb. 5-pol.	High Flex Leder	7T4SH083010035A54
ABITIG® 200F	4 m	ED	BSB 35-50 Rundsteckverb. 5-pol.	Standard	7T4FK043010035A54
	8 m	ED	BSB 35-50 Rundsteckverb. 5-pol.	Standard	7T4FK083010035A54
	4 m	ED	BSB 35-50 Rundsteckverb. 5-pol.	High Flex Leder	7T4FH043010035A54
	8 m	ED	BSB 35-50 Rundsteckverb. 5-pol.	High Flex Leder	7T4FH083010035A54
ABITIG® 150	4 m	ED	BSB 35-50 Rundsteckverb. 5-pol.	Standard	7T6SK043010035A54
	8 m	ED	BSB 35-50 Rundsteckverb. 5-pol.	Standard	7T6SK083010035A54
	4 m	ED	BSB 35-50 Rundsteckverb. 5-pol.	High Flex Leder	7T6SH043010035A54
	8 m	ED	BSB 35-50 Rundsteckverb. 5-pol.	High Flex Leder	7T6SH083010035A54
ABITIG® 150F	4 m	ED	BSB 35-50 Rundsteckverb. 5-pol.	Standard	7T6FK043010035A54
	8 m	ED	BSB 35-50 Rundsteckverb. 5-pol.	Standard	7T6FK083010035A54
	4 m	ED	BSB 35-50 Rundsteckverb. 5-pol.	High Flex Leder	7T6FH043010035A54
	8 m	ED	BSB 35-50 Rundsteckverb. 5-pol.	High Flex Leder	7T6FH083010035A54

ABITIG®-Brennerpreisliste

passend für WIG-Stromquellen des Fabrikates „poro-bronze“



Brennertyp	Länge	Schalterfunktion	maschinenseitiger Anschluss	Schlauchpaketausführung	Bestellnummer
ABITIG® 9	4 m	ED/DD	BSB 35-50 Tuchel 5-pol.	Standard	7S1SK043020002A05
	8 m	ED/DD	BSB 35-50 Tuchel 5-pol.	Standard	7S1SK083020002A05
	4 m	ED/DD	BSB 35-50 Tuchel 5-pol.	High Flex Leder	7S1SH043020002A05
	8 m	ED/DD	BSB 35-50 Tuchel 5-pol.	High Flex Leder	7S1SH083020002A05

ABITIG® 9F	4 m	ED/DD	BSB 35-50 Tuchel 5-pol.	Standard	7S1FK043020002A05
	8 m	ED/DD	BSB 35-50 Tuchel 5-pol.	Standard	7S1FK083020002A05
	4 m	ED/DD	BSB 35-50 Tuchel 5-pol.	High Flex Leder	7S1FH043020002A05
	8 m	ED/DD	BSB 35-50 Tuchel 5-pol.	High Flex Leder	7S1FH083020002A05

ABITIG® 17	4 m	ED/DD	BSB 35-50 Tuchel 5-pol.	Standard	7S2SK043020002A05
	8 m	ED/DD	BSB 35-50 Tuchel 5-pol.	Standard	7S2SK083020002A05
	4 m	ED/DD	BSB 35-50 Tuchel 5-pol.	High Flex Leder	7S2SH043020002A05
	8 m	ED/DD	BSB 35-50 Tuchel 5-pol.	High Flex Leder	7S2SH083020002A05

ABITIG® 17F	4 m	ED/DD	BSB 35-50 Tuchel 5-pol.	Standard	7S2FK043020002A05
	8 m	ED/DD	BSB 35-50 Tuchel 5-pol.	Standard	7S2FK083020002A05
	4 m	ED/DD	BSB 35-50 Tuchel 5-pol.	High Flex Leder	7S2FH043020002A05
	8 m	ED/DD	BSB 35-50 Tuchel 5-pol.	High Flex Leder	7S2FH083020002A05

Technische Änderungen vorbehalten • Verkaufspreise = unverbindliche Preisempfehlung - Angebot freibleibend • © Copyright

ABITIG®-Brennerpreisliste

passend für WIG-Stromquellen des Fabrikates „poro-bronze“

Brennertyp	Länge	Schalterfunktion	maschinenseitiger Anschluss	Schlauchpaketausführung	Bestellnummer
ABITIG® 26	4 m	ED/DD	BSB 35-50 Tuchel 5-pol.	Standard	7S3SK043020002A05
	8 m	ED/DD	BSB 35-50 Tuchel 5-pol.	Standard	7S3SK083020002A05
	4 m	ED/DD	BSB 35-50 Tuchel 5-pol.	High Flex Leder	7S3SH043020002A05
	8 m	ED/DD	BSB 35-50 Tuchel 5-pol.	High Flex Leder	7S3SH083020002A05

ABITIG® 26F	4 m	ED/DD	BSB 35-50 Tuchel 5-pol.	Standard	7S3FK043020002A05
	8 m	ED/DD	BSB 35-50 Tuchel 5-pol.	Standard	7S3FK083020002A05
	4 m	ED/DD	BSB 35-50 Tuchel 5-pol.	High Flex Leder	7S3FH043020002A05
	8 m	ED/DD	BSB 35-50 Tuchel 5-pol.	High Flex Leder	7S3FH083020002A05

ABITIG® 24G	4 m	ED/DD	BSB 35-50 Tuchel 5-pol.	Standard	7S8SK043020002A05
	8 m	ED/DD	BSB 35-50 Tuchel 5-pol.	Standard	7S8SK083020002A05
	4 m	ED/DD	BSB 35-50 Tuchel 5-pol.	High Flex Leder	7S8SH043020002A05
	8 m	ED/DD	BSB 35-50 Tuchel 5-pol.	High Flex Leder	7S8SH083020002A05

ABITIG® 200	4 m	ED/DD	BSB 35-50 Tuchel 5-pol.	Standard	7T4SK043020002A05
	8 m	ED/DD	BSB 35-50 Tuchel 5-pol.	Standard	7T4SK083020002A05
	4 m	ED/DD	BSB 35-50 Tuchel 5-pol.	High Flex Leder	7T4SH043020002A05
	8 m	ED/DD	BSB 35-50 Tuchel 5-pol.	High Flex Leder	7T4SH083020002A05

ABITIG® 200F	4 m	ED/DD	BSB 35-50 Tuchel 5-pol.	Standard	7T4FK043020002A05
	8 m	ED/DD	BSB 35-50 Tuchel 5-pol.	Standard	7T4FK083020002A05
	4 m	ED/DD	BSB 35-50 Tuchel 5-pol.	High Flex Leder	7T4FH043020002A05
	8 m	ED/DD	BSB 35-50 Tuchel 5-pol.	High Flex Leder	7T4FH083020002A05

ABITIG® 150	4 m	ED/DD	BSB 35-50 Tuchel 5-pol.	Standard	7T6SK043020002A05
	8 m	ED/DD	BSB 35-50 Tuchel 5-pol.	Standard	7T6SK083020002A05
	4 m	ED/DD	BSB 35-50 Tuchel 5-pol.	High Flex Leder	7T6SH043020002A05
	8 m	ED/DD	BSB 35-50 Tuchel 5-pol.	High Flex Leder	7T6SH083020002A05

ABITIG® 150F	4 m	ED/DD	BSB 35-50 Tuchel 5-pol.	Standard	7T6FK043020002A05
	8 m	ED/DD	BSB 35-50 Tuchel 5-pol.	Standard	7T6FK083020002A05
	4 m	ED/DD	BSB 35-50 Tuchel 5-pol.	High Flex Leder	7T6FH043020002A05
	8 m	ED/DD	BSB 35-50 Tuchel 5-pol.	High Flex Leder	7T6FH083020002A05

ABITIG®-Brennerpreisliste

passend für WIG-Stromquellen des Fabrikates „poro-bronze“

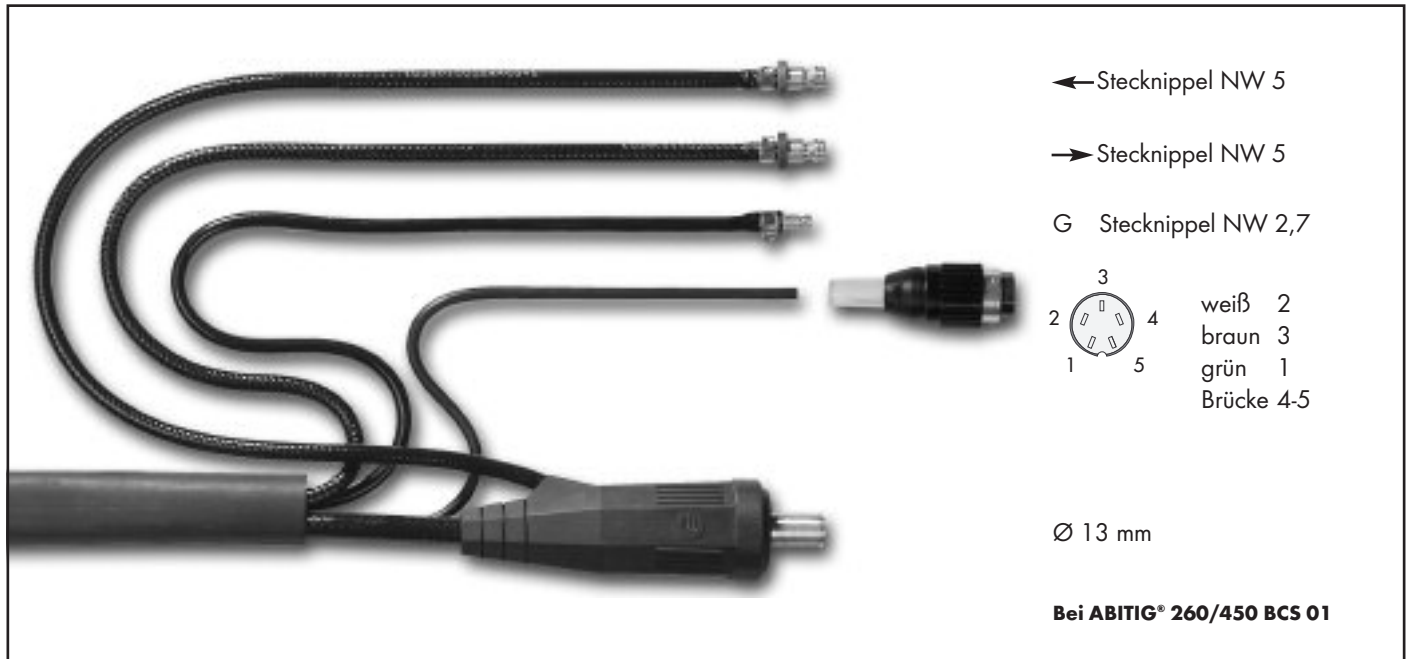

Brennertyp	Länge	Schalterfunktion	maschinenseitiger Anschluss	Schlauchpaketausführung	Bestellnummer
ABITIG® 18	4 m	ED/DD	BSB 35-50 Tuchel 5-pol.	Standard	7S4SK043020002A16
	8 m	ED/DD	BSB 35-50 Tuchel 5-pol.	Standard	7S4SK083020002A16
	4 m	ED/DD	BSB 35-50 Tuchel 5-pol.	High Flex Leder	7S4SH043020002A16
	8 m	ED/DD	BSB 35-50 Tuchel 5-pol.	High Flex Leder	7S4SH083020002A16
ABITIG® 18F	4 m	ED/DD	BSB 35-50 Tuchel 5-pol.	Standard	7S4FK043020002A16
	8 m	ED/DD	BSB 35-50 Tuchel 5-pol.	Standard	7S4FK083020002A16
	4 m	ED/DD	BSB 35-50 Tuchel 5-pol.	High Flex Leder	7S4FH043020002A16
	8 m	ED/DD	BSB 35-50 Tuchel 5-pol.	High Flex Leder	7S4FH083020002A16
ABITIG® 20	4 m	ED/DD	BSB 35-50 Tuchel 5-pol.	Standard	7S5SK043020002A16
	8 m	ED/DD	BSB 35-50 Tuchel 5-pol.	Standard	7S5SK083020002A16
	4 m	ED/DD	BSB 35-50 Tuchel 5-pol.	High Flex Leder	7S5SH043020002A16
	8 m	ED/DD	BSB 35-50 Tuchel 5-pol.	High Flex Leder	7S5SH083020002A16
ABITIG® 20F	4 m	ED/DD	BSB 35-50 Tuchel 5-pol.	Standard	7S5FK043020002A16
	8 m	ED/DD	BSB 35-50 Tuchel 5-pol.	Standard	7S5FK083020002A16
	4 m	ED/DD	BSB 35-50 Tuchel 5-pol.	High Flex Leder	7S5FH043020002A16
	8 m	ED/DD	BSB 35-50 Tuchel 5-pol.	High Flex Leder	7S5FH083020002A16

Technische Änderungen vorbehalten • Verkaufspreise = unverbindliche Preisempfehlung - Angebot freibleibend • © Copyright

ABITIG®-Brennerpreisliste

passend für WIG-Stromquellen des Fabrikates „poro-bronze“

Brennertyp	Länge	Schalterfunktion	maschinenseitiger Anschluss	Schlauchpaketausführung	Bestellnummer
ABITIG® 12-1	4 m	ED/DD	BSB 35-50 Tuchel 5-pol.	Standard	7S6SK043020002A16
	8 m	ED/DD	BSB 35-50 Tuchel 5-pol.	Standard	7S6SK083020002A16
	4 m	ED/DD	BSB 35-50 Tuchel 5-pol.	High Flex Leder	7S6SH043020002A16
	8 m	ED/DD	BSB 35-50 Tuchel 5-pol.	High Flex Leder	7S6SH083020002A16
ABITIG® 18SC	4 m	ED/DD	BSB 35-50 Tuchel 5-pol.	Standard	7S7SK043020002A16
	8 m	ED/DD	BSB 35-50 Tuchel 5-pol.	Standard	7S7SK083020002A16
	4 m	ED/DD	BSB 35-50 Tuchel 5-pol.	High Flex Leder	7S7SH043020002A16
	8 m	ED/DD	BSB 35-50 Tuchel 5-pol.	High Flex Leder	7S7SH083020002A16
ABITIG® 24W	4 m	ED/DD	BSB 35-50 Tuchel 5-pol.	Standard	7S9SK043020002A16
	8 m	ED/DD	BSB 35-50 Tuchel 5-pol.	Standard	7S9SK083020002A16
	4 m	ED/DD	BSB 35-50 Tuchel 5-pol.	High Flex Leder	7S9SH043020002A16
	8 m	ED/DD	BSB 35-50 Tuchel 5-pol.	High Flex Leder	7S9SH083020002A16
ABITIG® 450W	4 m	ED/DD	BSB 35-50 Tuchel 5-pol.	Standard	7T5SK043020102A16
	8 m	ED/DD	BSB 35-50 Tuchel 5-pol.	Standard	7T5SK083020102A16
	4 m	ED/DD	BSB 35-50 Tuchel 5-pol.	High Flex Leder	7T5SH043020102A16
	8 m	ED/DD	BSB 35-50 Tuchel 5-pol.	High Flex Leder	7T5SH083020102A16
ABITIG® 260W	4 m	ED/DD	BSB 35-50 Tuchel 5-pol.	Standard	7T7SK043020102A16
	8 m	ED/DD	BSB 35-50 Tuchel 5-pol.	Standard	7T7SK083020102A16
	4 m	ED/DD	BSB 35-50 Tuchel 5-pol.	High Flex Leder	7T7SH043020102A16
	8 m	ED/DD	BSB 35-50 Tuchel 5-pol.	High Flex Leder	7T7SH083020102A16
ABITIG® 450W SC	4 m	ED/DD	BSB 35-50 Tuchel 5-pol.	Standard	
	8 m	ED/DD	BSB 35-50 Tuchel 5-pol.	Standard	
	4 m	ED/DD	BSB 35-50 Tuchel 5-pol.	High Flex Leder	7T8SH043020102A16
	8 m	ED/DD	BSB 35-50 Tuchel 5-pol.	High Flex Leder	7T8SH083020102A16

ABITIG®-Brennerpreisliste

passend für WIG-Stromquellen des Fabrikates „rehm“



Brennertyp	Länge	Schalterfunktion	maschinenseitiger Anschluss	Schlauchpaketausführung	Bestellnummer
ABITIG® 9	4 m	ED/DD	BSB 35-50 Rundsteckverbinder 7-pol.	Standard	7S1SK043020012A05
	8 m	ED/DD	BSB 35-50 Rundsteckverbinder 7-pol.	Standard	7S1SK083020012A05
	4 m	ED/DD	BSB 35-50 Rundsteckverbinder 7-pol.	High Flex Leder	7S1SH043020012A05
	8 m	ED/DD	BSB 35-50 Rundsteckverbinder 7-pol.	High Flex Leder	7S1SH083020012A05
ABITIG® 9F	4 m	ED/DD	BSB 35-50 Rundsteckverbinder 7-pol.	Standard	7S1FK043020012A05
	8 m	ED/DD	BSB 35-50 Rundsteckverbinder 7-pol.	Standard	7S1FK083020012A05
	4 m	ED/DD	BSB 35-50 Rundsteckverbinder 7-pol.	High Flex Leder	7S1FH043020012A05
	8 m	ED/DD	BSB 35-50 Rundsteckverbinder 7-pol.	High Flex Leder	7S1FH083020012A05
ABITIG® 17	4 m	ED/DD	BSB 35-50 Rundsteckverbinder 7-pol.	Standard	7S2SK043020012A05
	8 m	ED/DD	BSB 35-50 Rundsteckverbinder 7-pol.	Standard	7S2SK083020012A05
	4 m	ED/DD	BSB 35-50 Rundsteckverbinder 7-pol.	High Flex Leder	7S2SH043020012A05
	8 m	ED/DD	BSB 35-50 Rundsteckverbinder 7-pol.	High Flex Leder	7S2SH083020012A05
ABITIG® 17F	4 m	ED/DD	BSB 35-50 Rundsteckverbinder 7-pol.	Standard	7S2FK043020012A05
	8 m	ED/DD	BSB 35-50 Rundsteckverbinder 7-pol.	Standard	7S2FK083020012A05
	4 m	ED/DD	BSB 35-50 Rundsteckverbinder 7-pol.	High Flex Leder	7S2FH043020012A05
	8 m	ED/DD	BSB 35-50 Rundsteckverbinder 7-pol.	High Flex Leder	7S2FH083020012A05

Technische Änderungen vorbehalten • Verkaufspreise = unverbindliche Preisempfehlung - Angebot freibleibend • © Copyright

ABITIG®-Brennerpreisliste

passend für WIG-Stromquellen des Fabrikates „rehm“

Brennertyp	Länge	Schalterfunktion	maschinenseitiger Anschluss	Schlauchpaketausführung	Bestellnummer
ABITIG® 26	4 m	ED/DD	BSB 35-50 Rundsteckverbinder 7-pol.	Standard	7S3SK043020012A05
	8 m	ED/DD	BSB 35-50 Rundsteckverbinder 7-pol.	Standard	7S3SK083020012A05
	4 m	ED/DD	BSB 35-50 Rundsteckverbinder 7-pol.	High Flex Leder	7S3SH043020012A05
	8 m	ED/DD	BSB 35-50 Rundsteckverbinder 7-pol.	High Flex Leder	7S3SH083020012A05
ABITIG® 26F	4 m	ED/DD	BSB 35-50 Rundsteckverbinder 7-pol.	Standard	7S3FK043020012A05
	8 m	ED/DD	BSB 35-50 Rundsteckverbinder 7-pol.	Standard	7S3FK083020012A05
	4 m	ED/DD	BSB 35-50 Rundsteckverbinder 7-pol.	High Flex Leder	7S3FH043020012A05
	8 m	ED/DD	BSB 35-50 Rundsteckverbinder 7-pol.	High Flex Leder	7S3FH083020012A05
ABITIG® 24G	4 m	ED/DD	BSB 35-50 Rundsteckverbinder 7-pol.	Standard	7S8SK043020012A05
	8 m	ED/DD	BSB 35-50 Rundsteckverbinder 7-pol.	Standard	7S8SK083020012A05
	4 m	ED/DD	BSB 35-50 Rundsteckverbinder 7-pol.	High Flex Leder	7S8SH043020012A05
	8 m	ED/DD	BSB 35-50 Rundsteckverbinder 7-pol.	High Flex Leder	7S8SH083020012A05
ABITIG® 200	4 m	ED/DD	BSB 35-50 Rundsteckverbinder 7-pol.	Standard	7T4SK043020012A05
	8 m	ED/DD	BSB 35-50 Rundsteckverbinder 7-pol.	Standard	7T4SK083020012A05
	4 m	ED/DD	BSB 35-50 Rundsteckverbinder 7-pol.	High Flex Leder	7T4SH043020012A05
	8 m	ED/DD	BSB 35-50 Rundsteckverbinder 7-pol.	High Flex Leder	7T4SH083020012A05
ABITIG® 200F	4 m	ED/DD	BSB 35-50 Rundsteckverbinder 7-pol.	Standard	7T4FK043020012A05
	8 m	ED/DD	BSB 35-50 Rundsteckverbinder 7-pol.	Standard	7T4FK083020012A05
	4 m	ED/DD	BSB 35-50 Rundsteckverbinder 7-pol.	High Flex Leder	7T4FH043020012A05
	8 m	ED/DD	BSB 35-50 Rundsteckverbinder 7-pol.	High Flex Leder	7T4FH083020012A05
ABITIG® 150	4 m	ED/DD	BSB 35-50 Rundsteckverbinder 7-pol.	Standard	7T6SK043020012A05
	8 m	ED/DD	BSB 35-50 Rundsteckverbinder 7-pol.	Standard	7T6SK083020012A05
	4 m	ED/DD	BSB 35-50 Rundsteckverbinder 7-pol.	High Flex Leder	7T6SH043020012A05
	8 m	ED/DD	BSB 35-50 Rundsteckverbinder 7-pol.	High Flex Leder	7T6SH083020012A05
ABITIG® 150F	4 m	ED/DD	BSB 35-50 Rundsteckverbinder 7-pol.	Standard	7T6FK043020012A05
	8 m	ED/DD	BSB 35-50 Rundsteckverbinder 7-pol.	Standard	7T6FK083020012A05
	4 m	ED/DD	BSB 35-50 Rundsteckverbinder 7-pol.	High Flex Leder	7T6FH043020012A05
	8 m	ED/DD	BSB 35-50 Rundsteckverbinder 7-pol.	High Flex Leder	7T6FH083020012A05

ABITIG®-Brennerpreisliste

passend für WIG-Stromquellen des Fabrikates „rehm“



Brennertyp	Länge	Schalterfunktion	maschinenseitiger Anschluss	Schlauchpaketausführung	Bestellnummer
ABITIG® 9	4 m	DDP	BSB 35-50 Stecker1) + Stecker2)	Standard	7S1SK046040021A05
	8 m	DDP	BSB 35-50 Stecker1) + Stecker2)	Standard	7S1SK086040021A05
	4 m	DDP	BSB 35-50 Stecker1) + Stecker2)	High Flex Leder	7S1SH046040021A05
	8 m	DDP	BSB 35-50 Stecker1) + Stecker2)	High Flex Leder	7S1SH086040021A05
ABITIG® 9F	4 m	DDP	BSB 35-50 Stecker1) + Stecker2)	Standard	7S1FK046040021A05
	8 m	DDP	BSB 35-50 Stecker1) + Stecker2)	Standard	7S1FK086040021A05
	4 m	DDP	BSB 35-50 Stecker1) + Stecker2)	High Flex Leder	7S1FH046040021A05
	8 m	DDP	BSB 35-50 Stecker1) + Stecker2)	High Flex Leder	7S1FH086040021A05
ABITIG® 17	4 m	DDP	BSB 35-50 Stecker1) + Stecker2)	Standard	7S2SK046040021A05
	8 m	DDP	BSB 35-50 Stecker1) + Stecker2)	Standard	7S2SK086040021A05
	4 m	DDP	BSB 35-50 Stecker1) + Stecker2)	High Flex Leder	7S2SH046040021A05
	8 m	DDP	BSB 35-50 Stecker1) + Stecker2)	High Flex Leder	7S2SH086040021A05
ABITIG® 17F	4 m	DDP	BSB 35-50 Stecker1) + Stecker2)	Standard	7S2FK046040021A05
	8 m	DDP	BSB 35-50 Stecker1) + Stecker2)	Standard	7S2FK086040021A05
	4 m	DDP	BSB 35-50 Stecker1) + Stecker2)	High Flex Leder	7S2FH046040021A05
	8 m	DDP	BSB 35-50 Stecker1) + Stecker2)	High Flex Leder	7S2FH086040021A05

Technische Änderungen vorbehalten • Verkaufspreise = unverbindliche Preisempfehlung - Angebot freibleibend • © Copyright

ABITIG®-Brennerpreisliste

passend für WIG-Stromquellen des Fabrikates „rehm“

Brennertyp	Länge	Schalterfunktion	maschinenseitiger Anschluss	Schlauchpaketausführung	Bestellnummer
ABITIG® 26	4 m	DDP	BSB 35-50 Stecker1) + Stecker2)	Standard	7S3SK046040021A05
	8 m	DDP	BSB 35-50 Stecker1) + Stecker2)	Standard	7S3SK086040021A05
	4 m	DDP	BSB 35-50 Stecker1) + Stecker2)	High Flex Leder	7S3SH046040021A05
	8 m	DDP	BSB 35-50 Stecker1) + Stecker2)	High Flex Leder	7S3SH086040021A05
ABITIG® 26F	4 m	DDP	BSB 35-50 Stecker1) + Stecker2)	Standard	7S3FK046040021A05
	8 m	DDP	BSB 35-50 Stecker1) + Stecker2)	Standard	7S3FK086040021A05
	4 m	DDP	BSB 35-50 Stecker1) + Stecker2)	High Flex Leder	7S3FH046040021A05
	8 m	DDP	BSB 35-50 Stecker1) + Stecker2)	High Flex Leder	7S3FH086040021A05
ABITIG® 24G	4 m	DDP	BSB 35-50 Stecker1) + Stecker2)	Standard	7S8SK046040021A05
	8 m	DDP	BSB 35-50 Stecker1) + Stecker2)	Standard	7S8SK086040021A05
	4 m	DDP	BSB 35-50 Stecker1) + Stecker2)	High Flex Leder	7S8SH046040021A05
	8 m	DDP	BSB 35-50 Stecker1) + Stecker2)	High Flex Leder	7S8SH086040021A05
ABITIG® 200	4 m	DDP	BSB 35-50 Stecker1) + Stecker2)	Standard	7T4SK046040021A05
	8 m	DDP	BSB 35-50 Stecker1) + Stecker2)	Standard	7T4SK086040021A05
	4 m	DDP	BSB 35-50 Stecker1) + Stecker2)	High Flex Leder	7T4SH046040021A05
	8 m	DDP	BSB 35-50 Stecker1) + Stecker2)	High Flex Leder	7T4SH086040021A05
ABITIG® 200F	4 m	DDP	BSB 35-50 Stecker1) + Stecker2)	Standard	7T4FK046040021A05
	8 m	DDP	BSB 35-50 Stecker1) + Stecker2)	Standard	7T4FK086040021A05
	4 m	DDP	BSB 35-50 Stecker1) + Stecker2)	High Flex Leder	7T4FH046040021A05
	8 m	DDP	BSB 35-50 Stecker1) + Stecker2)	High Flex Leder	7T4FH086040021A05
ABITIG® 150	4 m	DDP	BSB 35-50 Stecker1) + Stecker2)	Standard	7T6SK046040021A05
	8 m	DDP	BSB 35-50 Stecker1) + Stecker2)	Standard	7T6SK086040021A05
	4 m	DDP	BSB 35-50 Stecker1) + Stecker2)	High Flex Leder	7T6SH046040021A05
	8 m	DDP	BSB 35-50 Stecker1) + Stecker2)	High Flex Leder	7T6SH086040021A05
ABITIG® 150F	4 m	DDP	BSB 35-50 Stecker1) + Stecker2)	Standard	7T6FK046040021A05
	8 m	DDP	BSB 35-50 Stecker1) + Stecker2)	Standard	7T6FK086040021A05
	4 m	DDP	BSB 35-50 Stecker1) + Stecker2)	High Flex Leder	7T6FH046040021A05
	8 m	DDP	BSB 35-50 Stecker1) + Stecker2)	High Flex Leder	7T6FH086040021A05

Stecker¹⁾ = Rundsteckverbinder 7-pol.

Stecker²⁾ = Amphenol 18-pol.

ABITIG®-Brennerpreisliste

passend für WIG-Stromquellen des Fabrikates „rehm“

Rehm Tiger B mit Kunststoffgehäuse
Rehm Tiger A mit Blechgehäuse



Stecknippel NW 2,7

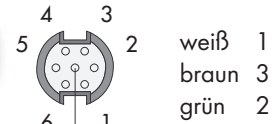

Abschirmung auf PIN 7

Ø 13 mm

Abgeschirmte Steuerleitung

Brennertyp	Länge	Schalterfunktion	maschinenseitiger Anschluss	Schlauchpaketausführung	Bestellnummer
ABITIG® 9	4 m	DD	BSB 35-50 Rundsteckverbinder 7-pol.	Standard	7S1SK047020012A05
	8 m	DD	BSB 35-50 Rundsteckverbinder 7-pol.	Standard	7S1SK087020012A05
	4 m	DD	BSB 35-50 Rundsteckverbinder 7-pol.	High Flex Leder	7S1SH047020012A05
	8 m	DD	BSB 35-50 Rundsteckverbinder 7-pol.	High Flex Leder	7S1SH087020012A05
ABITIG® 9F	4 m	DD	BSB 35-50 Rundsteckverbinder 7-pol.	Standard	7S1FK047020012A05
	8 m	DD	BSB 35-50 Rundsteckverbinder 7-pol.	Standard	7S1FK087020012A05
	4 m	DD	BSB 35-50 Rundsteckverbinder 7-pol.	High Flex Leder	7S1FH047020012A05
	8 m	DD	BSB 35-50 Rundsteckverbinder 7-pol.	High Flex Leder	7S1FH087020012A05
ABITIG® 17	4 m	DD	BSB 35-50 Rundsteckverbinder 7-pol.	Standard	7S2SK047020012A05
	8 m	DD	BSB 35-50 Rundsteckverbinder 7-pol.	Standard	7S2SK087020012A05
	4 m	DD	BSB 35-50 Rundsteckverbinder 7-pol.	High Flex Leder	7S2SH047020012A05
	8 m	DD	BSB 35-50 Rundsteckverbinder 7-pol.	High Flex Leder	7S2SH087020012A05
ABITIG® 17F	4 m	DD	BSB 35-50 Rundsteckverbinder 7-pol.	Standard	7S2FK047020012A05
	8 m	DD	BSB 35-50 Rundsteckverbinder 7-pol.	Standard	7S2FK087020012A05
	4 m	DD	BSB 35-50 Rundsteckverbinder 7-pol.	High Flex Leder	7S2FH047020012A05
	8 m	DD	BSB 35-50 Rundsteckverbinder 7-pol.	High Flex Leder	7S2FH087020012A05

Technische Änderungen vorbehalten • Verkaufspreise = unverbindliche Preisempfehlung - Angebot freibleibend • © Copyright

ABITIG®-Brennerpreisliste

passend für WIG-Stromquellen des Fabrikates „rehm“

Brennertyp	Länge	Schalterfunktion	maschinenseitiger Anschluss	Schlauchpaketausführung	Bestellnummer
ABITIG® 26	4 m	DD	BSB 35-50 Rundsteckverbinder 7-pol.	Standard	7S3SK047020012A05
	8 m	DD	BSB 35-50 Rundsteckverbinder 7-pol.	Standard	7S3SK087020012A05
	4 m	DD	BSB 35-50 Rundsteckverbinder 7-pol.	High Flex Leder	7S3SH047020012A05
	8 m	DD	BSB 35-50 Rundsteckverbinder 7-pol.	High Flex Leder	7S3SH087020012A05
ABITIG® 26F	4 m	DD	BSB 35-50 Rundsteckverbinder 7-pol.	Standard	7S3FK047020012A05
	8 m	DD	BSB 35-50 Rundsteckverbinder 7-pol.	Standard	7S3FK087020012A05
	4 m	DD	BSB 35-50 Rundsteckverbinder 7-pol.	High Flex Leder	7S3FH047020012A05
	8 m	DD	BSB 35-50 Rundsteckverbinder 7-pol.	High Flex Leder	7S3FH087020012A05
ABITIG® 24G	4 m	DD	BSB 35-50 Rundsteckverbinder 7-pol.	Standard	7S8SK047020012A05
	8 m	DD	BSB 35-50 Rundsteckverbinder 7-pol.	Standard	7S8SK087020012A05
	4 m	DD	BSB 35-50 Rundsteckverbinder 7-pol.	High Flex Leder	7S8SH047020012A05
	8 m	DD	BSB 35-50 Rundsteckverbinder 7-pol.	High Flex Leder	7S8SH087020012A05
ABITIG® 200	4 m	DD	BSB 35-50 Rundsteckverbinder 7-pol.	Standard	7T4SK047020012A05
	8 m	DD	BSB 35-50 Rundsteckverbinder 7-pol.	Standard	7T4SK087020012A05
	4 m	DD	BSB 35-50 Rundsteckverbinder 7-pol.	High Flex Leder	7T4SH047020012A05
	8 m	DD	BSB 35-50 Rundsteckverbinder 7-pol.	High Flex Leder	7T4SH087020012A05
ABITIG® 200F	4 m	DD	BSB 35-50 Rundsteckverbinder 7-pol.	Standard	7T4FK047020012A05
	8 m	DD	BSB 35-50 Rundsteckverbinder 7-pol.	Standard	7T4FK087020012A05
	4 m	DD	BSB 35-50 Rundsteckverbinder 7-pol.	High Flex Leder	7T4FH047020012A05
	8 m	DD	BSB 35-50 Rundsteckverbinder 7-pol.	High Flex Leder	7T4FH087020012A05
ABITIG® 150	4 m	DD	BSB 35-50 Rundsteckverbinder 7-pol.	Standard	7T6SK047020012A05
	8 m	DD	BSB 35-50 Rundsteckverbinder 7-pol.	Standard	7T6SK087020012A05
	4 m	DD	BSB 35-50 Rundsteckverbinder 7-pol.	High Flex Leder	7T6SH047020012A05
	8 m	DD	BSB 35-50 Rundsteckverbinder 7-pol.	High Flex Leder	7T6SH087020012A05
ABITIG® 150F	4 m	DD	BSB 35-50 Rundsteckverbinder 7-pol.	Standard	7T6FK047020012A05
	8 m	DD	BSB 35-50 Rundsteckverbinder 7-pol.	Standard	7T6FK087020012A05
	4 m	DD	BSB 35-50 Rundsteckverbinder 7-pol.	High Flex Leder	7T6FH047020012A05
	8 m	DD	BSB 35-50 Rundsteckverbinder 7-pol.	High Flex Leder	7T6FH087020012A05

ABITIG®-Brennerpreisliste

passend für WIG-Stromquellen des Fabrikates „rehm“

Rehm Tiger A mit Blechgehäuse



Abgeschirmte Steuerleitung

Brennertyp	Länge	Schalterfunktion	maschinenseitiger Anschluss	Schlauchpaketausführung	Bestellnummer
ABITIG® 9	4 m	DDP	BSB 35-50 Stecker1) + Stecker2)	Standard	7S1SK047040021C05
	8 m	DDP	BSB 35-50 Stecker1) + Stecker2)	Standard	7S1SK087040021C05
	4 m	DDP	BSB 35-50 Stecker1) + Stecker2)	High Flex Leder	7S1SH047040021C05
	8 m	DDP	BSB 35-50 Stecker1) + Stecker2)	High Flex Leder	7S1SH087040021C05
ABITIG® 9F	4 m	DDP	BSB 35-50 Stecker1) + Stecker2)	Standard	7S1FK047040021C05
	8 m	DDP	BSB 35-50 Stecker1) + Stecker2)	Standard	7S1FK087040021C05
	4 m	DDP	BSB 35-50 Stecker1) + Stecker2)	High Flex Leder	7S1FH047040021C05
	8 m	DDP	BSB 35-50 Stecker1) + Stecker2)	High Flex Leder	7S1FH087040021C05
ABITIG® 17	4 m	DDP	BSB 35-50 Stecker1) + Stecker2)	Standard	7S2SK047040021C05
	8 m	DDP	BSB 35-50 Stecker1) + Stecker2)	Standard	7S2SK087040021C05
	4 m	DDP	BSB 35-50 Stecker1) + Stecker2)	High Flex Leder	7S2SH047040021C05
	8 m	DDP	BSB 35-50 Stecker1) + Stecker2)	High Flex Leder	7S2SH087040021C05
ABITIG® 17F	4 m	DDP	BSB 35-50 Stecker1) + Stecker2)	Standard	7S2FK047040021C05
	8 m	DDP	BSB 35-50 Stecker1) + Stecker2)	Standard	7S2FK087040021C05
	4 m	DDP	BSB 35-50 Stecker1) + Stecker2)	High Flex Leder	7S2FH047040021C05
	8 m	DDP	BSB 35-50 Stecker1) + Stecker2)	High Flex Leder	7S2FH087040021C05

Technische Änderungen vorbehalten • Verkaufspreise = unverbindliche Preisempfehlung - Angebot freibleibend • © Copyright

ABITIG®-Brennerpreisliste

passend für WIG-Stromquellen des Fabrikates „rehm“

Brennertyp	Länge	Schalterfunktion	maschinenseitiger Anschluss	Schlauchpaketausführung	Bestellnummer
ABITIG® 26	4 m	DDP	BSB 35-50 Stecker1) + Stecker2)	Standard	7S3SK047040021C05
	8 m	DDP	BSB 35-50 Stecker1) + Stecker2)	Standard	7S3SK087040021C05
	4 m	DDP	BSB 35-50 Stecker1) + Stecker2)	High Flex Leder	7S3SH047040021C05
	8 m	DDP	BSB 35-50 Stecker1) + Stecker2)	High Flex Leder	7S3SH087040021C05
ABITIG® 26F	4 m	DDP	BSB 35-50 Stecker1) + Stecker2)	Standard	7S3FK047040021C05
	8 m	DDP	BSB 35-50 Stecker1) + Stecker2)	Standard	7S3FK087040021C05
	4 m	DDP	BSB 35-50 Stecker1) + Stecker2)	High Flex Leder	7S3FH047040021C05
	8 m	DDP	BSB 35-50 Stecker1) + Stecker2)	High Flex Leder	7S3FH087040021C05
ABITIG® 24G	4 m	DDP	BSB 35-50 Stecker1) + Stecker2)	Standard	7S8SK047040021C05
	8 m	DDP	BSB 35-50 Stecker1) + Stecker2)	Standard	7S8SK087040021C05
	4 m	DDP	BSB 35-50 Stecker1) + Stecker2)	High Flex Leder	7S8SH047040021C05
	8 m	DDP	BSB 35-50 Stecker1) + Stecker2)	High Flex Leder	7S8SH087040021C05
ABITIG® 200	4 m	DDP	BSB 35-50 Stecker1) + Stecker2)	Standard	7T4SK047040021C05
	8 m	DDP	BSB 35-50 Stecker1) + Stecker2)	Standard	7T4SK087040021C05
	4 m	DDP	BSB 35-50 Stecker1) + Stecker2)	High Flex Leder	7T4SH047040021C05
	8 m	DDP	BSB 35-50 Stecker1) + Stecker2)	High Flex Leder	7T4SH087040021C05
ABITIG® 200F	4 m	DDP	BSB 35-50 Stecker1) + Stecker2)	Standard	7T4FK047040021C05
	8 m	DDP	BSB 35-50 Stecker1) + Stecker2)	Standard	7T4FK087040021C05
	4 m	DDP	BSB 35-50 Stecker1) + Stecker2)	High Flex Leder	7T4FH047040021C05
	8 m	DDP	BSB 35-50 Stecker1) + Stecker2)	High Flex Leder	7T4FH087040021C05
ABITIG® 150	4 m	DDP	BSB 35-50 Stecker1) + Stecker2)	Standard	7T6SK047040021C05
	8 m	DDP	BSB 35-50 Stecker1) + Stecker2)	Standard	7T6SK087040021C05
	4 m	DDP	BSB 35-50 Stecker1) + Stecker2)	High Flex Leder	7T6SH047040021C05
	8 m	DDP	BSB 35-50 Stecker1) + Stecker2)	High Flex Leder	7T6SH087040021C05
ABITIG® 150F	4 m	DDP	BSB 35-50 Stecker1) + Stecker2)	Standard	7T6FK047040021C05
	8 m	DDP	BSB 35-50 Stecker1) + Stecker2)	Standard	7T6FK087040021C05
	4 m	DDP	BSB 35-50 Stecker1) + Stecker2)	High Flex Leder	7T6FH047040021C05
	8 m	DDP	BSB 35-50 Stecker1) + Stecker2)	High Flex Leder	7T6FH087040021C05

Stecker¹⁾ = Rundsteckverbinder 7-pol.

Stecker²⁾ = Amphenol 18-pol.

ABITIG®-Brennerpreisliste

passend für WIG-Stromquellen des Fabrikates „rehm“

Nur Rehm Tiger B mit Kunststoffgehäuse



Stecknippel NW 2,7

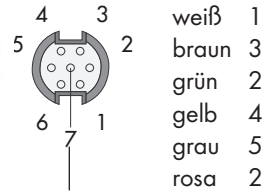

Abschirmung auf PIN 7

Ø 13 mm

Brennertyp	Länge	Schalterfunktion	maschinenseitiger Anschluss	Schlauchpaketausführung	Bestellnummer
ABITIG® 9	4 m	DDP	BSB 35-50 Rundsteckverbinder 7-pol.	Standard	7S1SK047040021D05
	8 m	DDP	BSB 35-50 Rundsteckverbinder 7-pol.	Standard	7S1SK087040021D05
	4 m	DDP	BSB 35-50 Rundsteckverbinder 7-pol.	High Flex Leder	7S1SH047040021D05
	8 m	DDP	BSB 35-50 Rundsteckverbinder 7-pol.	High Flex Leder	7S1SH087040021D05
ABITIG® 9F	4 m	DDP	BSB 35-50 Rundsteckverbinder 7-pol.	Standard	7S1FK047040021D05
	8 m	DDP	BSB 35-50 Rundsteckverbinder 7-pol.	Standard	7S1FK087040021D05
	4 m	DDP	BSB 35-50 Rundsteckverbinder 7-pol.	High Flex Leder	7S1FH047040021D05
	8 m	DDP	BSB 35-50 Rundsteckverbinder 7-pol.	High Flex Leder	7S1FH087040021D05
ABITIG® 17	4 m	DDP	BSB 35-50 Rundsteckverbinder 7-pol.	Standard	7S2SK047040021D05
	8 m	DDP	BSB 35-50 Rundsteckverbinder 7-pol.	Standard	7S2SK087040021D05
	4 m	DDP	BSB 35-50 Rundsteckverbinder 7-pol.	High Flex Leder	7S2SH047040021D05
	8 m	DDP	BSB 35-50 Rundsteckverbinder 7-pol.	High Flex Leder	7S2SH087040021D05
ABITIG® 17F	4 m	DDP	BSB 35-50 Rundsteckverbinder 7-pol.	Standard	7S2FK047040021D05
	8 m	DDP	BSB 35-50 Rundsteckverbinder 7-pol.	Standard	7S2FK087040021D05
	4 m	DDP	BSB 35-50 Rundsteckverbinder 7-pol.	High Flex Leder	7S2FH047040021D05
	8 m	DDP	BSB 35-50 Rundsteckverbinder 7-pol.	High Flex Leder	7S2FH087040021D05

Technische Änderungen vorbehalten • Verkaufspreise = unverbindliche Preisempfehlung - Angebot freibleibend • © Copyright

ABITIG®-Brennerpreisliste

passend für WIG-Stromquellen des Fabrikates „rehm“

Brennertyp	Länge	Schalterfunktion	maschinenseitiger Anschluss	Schlauchpaketausführung	Bestellnummer
ABITIG® 26	4 m	DDP	BSB 35-50 Rundsteckverbinder 7-pol.	Standard	7S3SK047040021D05
	8 m	DDP	BSB 35-50 Rundsteckverbinder 7-pol.	Standard	7S3SK087040021D05
	4 m	DDP	BSB 35-50 Rundsteckverbinder 7-pol.	High Flex Leder	7S3SH047040021D05
	8 m	DDP	BSB 35-50 Rundsteckverbinder 7-pol.	High Flex Leder	7S3SH087040021D05
ABITIG® 26F	4 m	DDP	BSB 35-50 Rundsteckverbinder 7-pol.	Standard	7S3FK047040021D05
	8 m	DDP	BSB 35-50 Rundsteckverbinder 7-pol.	Standard	7S3FK087040021D05
	4 m	DDP	BSB 35-50 Rundsteckverbinder 7-pol.	High Flex Leder	7S3FH047040021D05
	8 m	DDP	BSB 35-50 Rundsteckverbinder 7-pol.	High Flex Leder	7S3FH087040021D05
ABITIG® 24G	4 m	DDP	BSB 35-50 Rundsteckverbinder 7-pol.	Standard	7S8SK047040021D05
	8 m	DDP	BSB 35-50 Rundsteckverbinder 7-pol.	Standard	7S8SK087040021D05
	4 m	DDP	BSB 35-50 Rundsteckverbinder 7-pol.	High Flex Leder	7S8SH047040021D05
	8 m	DDP	BSB 35-50 Rundsteckverbinder 7-pol.	High Flex Leder	7S8SH087040021D05
ABITIG® 200	4 m	DDP	BSB 35-50 Rundsteckverbinder 7-pol.	Standard	7T4SK047040021D05
	8 m	DDP	BSB 35-50 Rundsteckverbinder 7-pol.	Standard	7T4SK087040021D05
	4 m	DDP	BSB 35-50 Rundsteckverbinder 7-pol.	High Flex Leder	7T4SH047040021D05
	8 m	DDP	BSB 35-50 Rundsteckverbinder 7-pol.	High Flex Leder	7T4SH087040021D05
ABITIG® 200F	4 m	DDP	BSB 35-50 Rundsteckverbinder 7-pol.	Standard	7T4FK047040021D05
	8 m	DDP	BSB 35-50 Rundsteckverbinder 7-pol.	Standard	7T4FK087040021D05
	4 m	DDP	BSB 35-50 Rundsteckverbinder 7-pol.	High Flex Leder	7T4FH047040021D05
	8 m	DDP	BSB 35-50 Rundsteckverbinder 7-pol.	High Flex Leder	7T4FH087040021D05
ABITIG® 150	4 m	DDP	BSB 35-50 Rundsteckverbinder 7-pol.	Standard	7T6SK047040021D05
	8 m	DDP	BSB 35-50 Rundsteckverbinder 7-pol.	Standard	7T6SK087040021D05
	4 m	DDP	BSB 35-50 Rundsteckverbinder 7-pol.	High Flex Leder	7T6SH047040021D05
	8 m	DDP	BSB 35-50 Rundsteckverbinder 7-pol.	High Flex Leder	7T6SH087040021D05
ABITIG® 150F	4 m	DDP	BSB 35-50 Rundsteckverbinder 7-pol.	Standard	7T6FK047040021D05
	8 m	DDP	BSB 35-50 Rundsteckverbinder 7-pol.	Standard	7T6FK087040021D05
	4 m	DDP	BSB 35-50 Rundsteckverbinder 7-pol.	High Flex Leder	7T6FH047040021D05
	8 m	DDP	BSB 35-50 Rundsteckverbinder 7-pol.	High Flex Leder	7T6FH087040021D05

ABITIG®-Brennerpreisliste

passend für WIG-Stromquellen des Fabrikates „rehm“



Brennertyp	Länge	Schalterfunktion	maschinenseitiger Anschluss	Schlauchpaketausführung	Bestellnummer
ABITIG® 18	4 m	ED/DD	BSB 35-50 Rundsteckverbinder 7-pol.	Standard	7S4SK043020003A16
	8 m	ED/DD	BSB 35-50 Rundsteckverbinder 7-pol.	Standard	7S4SK083020003A16
	4 m	ED/DD	BSB 35-50 Rundsteckverbinder 7-pol.	High Flex Leder	7S4SH043020003A16
	8 m	ED/DD	BSB 35-50 Rundsteckverbinder 7-pol.	High Flex Leder	7S4SH083020003A16
ABITIG® 18F	4 m	ED/DD	BSB 35-50 Rundsteckverbinder 7-pol.	Standard	7S4FK043020003A16
	8 m	ED/DD	BSB 35-50 Rundsteckverbinder 7-pol.	Standard	7S4FK083020003A16
	4 m	ED/DD	BSB 35-50 Rundsteckverbinder 7-pol.	High Flex Leder	7S4FH043020003A16
	8 m	ED/DD	BSB 35-50 Rundsteckverbinder 7-pol.	High Flex Leder	7S4FH083020003A16
ABITIG® 20	4 m	ED/DD	BSB 35-50 Rundsteckverbinder 7-pol.	Standard	7S5SK043020003A16
	8 m	ED/DD	BSB 35-50 Rundsteckverbinder 7-pol.	Standard	7S5SK083020003A16
	4 m	ED/DD	BSB 35-50 Rundsteckverbinder 7-pol.	High Flex Leder	7S5SH043020003A16
	8 m	ED/DD	BSB 35-50 Rundsteckverbinder 7-pol.	High Flex Leder	7S5SH083020003A16
ABITIG® 20F	4 m	ED/DD	BSB 35-50 Rundsteckverbinder 7-pol.	Standard	7S5FK043020003A16
	8 m	ED/DD	BSB 35-50 Rundsteckverbinder 7-pol.	Standard	7S5FK083020003A16
	4 m	ED/DD	BSB 35-50 Rundsteckverbinder 7-pol.	High Flex Leder	7S5FH043020003A16
	8 m	ED/DD	BSB 35-50 Rundsteckverbinder 7-pol.	High Flex Leder	7S5FH083020003A16

Technische Änderungen vorbehalten • Verkaufspreise = unverbindliche Preisempfehlung - Angebot freibleibend • © Copyright

ABITIG®-Brennerpreisliste

passend für WIG-Stromquellen des Fabrikates „rehm“

Brennertyp	Länge	Schalterfunktion	maschinenseitiger Anschluss	Schlauchpaketausführung	Bestellnummer
ABITIG® 12-1	4 m	ED/DD	BSB 35-50 Rundsteckverbinder 7-pol.	Standard	7S6SK043020003A16
	8 m	ED/DD	BSB 35-50 Rundsteckverbinder 7-pol.	Standard	7S6SK083020003A16
	4 m	ED/DD	BSB 35-50 Rundsteckverbinder 7-pol.	High Flex Leder	7S6SH043020003A16
	8 m	ED/DD	BSB 35-50 Rundsteckverbinder 7-pol.	High Flex Leder	7S6SH083020003A16
ABITIG® 18SC	4 m	ED/DD	BSB 35-50 Rundsteckverbinder 7-pol.	Standard	7S7SK043020003A16
	8 m	ED/DD	BSB 35-50 Rundsteckverbinder 7-pol.	Standard	7S7SK083020003A16
	4 m	ED/DD	BSB 35-50 Rundsteckverbinder 7-pol.	High Flex Leder	7S7SH043020003A16
	8 m	ED/DD	BSB 35-50 Rundsteckverbinder 7-pol.	High Flex Leder	7S7SH083020003A16
ABITIG® 24W	4 m	ED/DD	BSB 35-50 Rundsteckverbinder 7-pol.	Standard	7S9SK043020003A16
	8 m	ED/DD	BSB 35-50 Rundsteckverbinder 7-pol.	Standard	7S9SK083020003A16
	4 m	ED/DD	BSB 35-50 Rundsteckverbinder 7-pol.	High Flex Leder	7S9SH043020003A16
	8 m	ED/DD	BSB 35-50 Rundsteckverbinder 7-pol.	High Flex Leder	7S9SH083020003A16
ABITIG® 450W	4 m	ED/DD	BSB 35-50 Rundsteckverbinder 7-pol.	Standard	7T5SK043020103A16
	8 m	ED/DD	BSB 35-50 Rundsteckverbinder 7-pol.	Standard	7T5SK083020103A16
	4 m	ED/DD	BSB 35-50 Rundsteckverbinder 7-pol.	High Flex Leder	7T5SH043020103A16
	8 m	ED/DD	BSB 35-50 Rundsteckverbinder 7-pol.	High Flex Leder	7T5SH083020103A16
ABITIG® 260W	4 m	ED/DD	BSB 35-50 Rundsteckverbinder 7-pol.	Standard	7T7SK043020103A16
	8 m	ED/DD	BSB 35-50 Rundsteckverbinder 7-pol.	Standard	7T7SK083020103A16
	4 m	ED/DD	BSB 35-50 Rundsteckverbinder 7-pol.	High Flex Leder	7T7SH043020103A16
	8 m	ED/DD	BSB 35-50 Rundsteckverbinder 7-pol.	High Flex Leder	7T7SH083020103A16
ABITIG® 450W SC	4 m	ED/DD	BSB 35-50 Rundsteckverbinder 7-pol.	Standard	
	8 m	ED/DD	BSB 35-50 Rundsteckverbinder 7-pol.	Standard	
	4 m	ED/DD	BSB 35-50 Rundsteckverbinder 7-pol.	High Flex Leder	7T8SH043020103A16
	8 m	ED/DD	BSB 35-50 Rundsteckverbinder 7-pol.	High Flex Leder	7T8SH083020103A16

ABITIG®-Brennerpreisliste

passend für WIG-Stromquellen des Fabrikates „rehm“

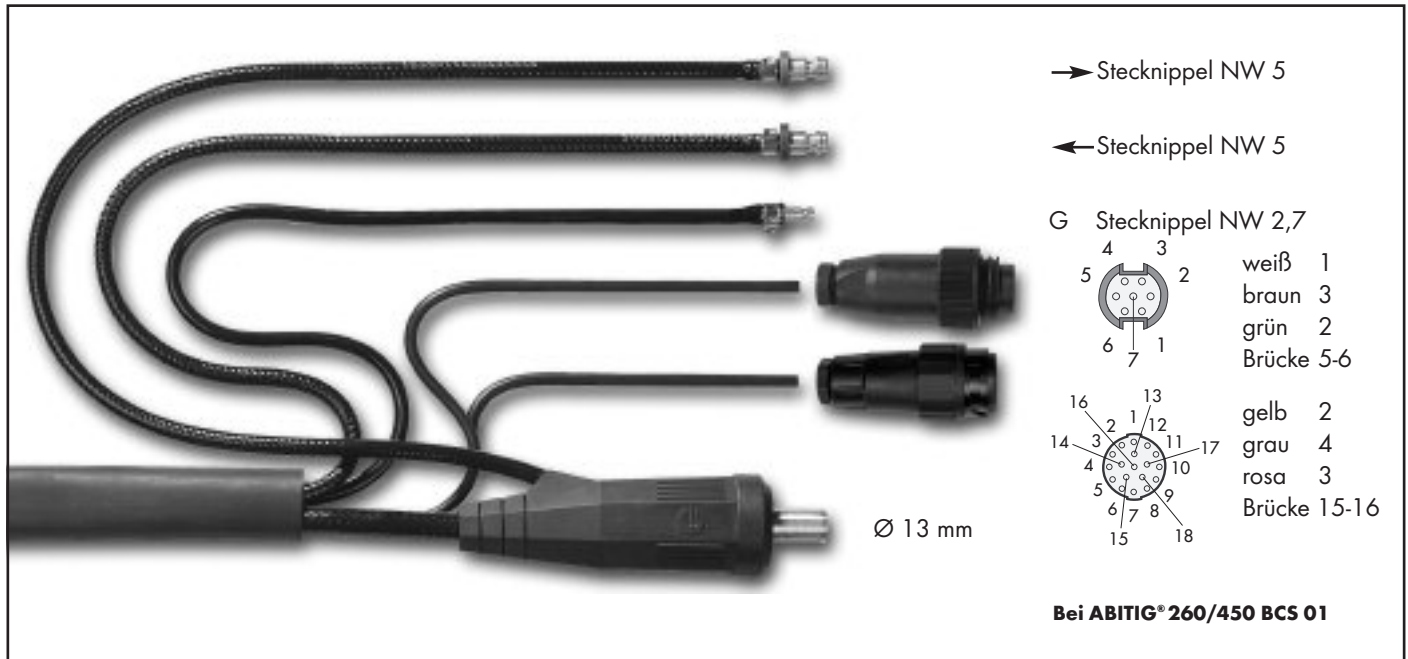

Brennertyp	Länge	Schalterfunktion	maschinenseitiger Anschluss	Schlauchpaketausführung	Bestellnummer
ABITIG® 18	4 m	DDP	BSB 35-50 Stecker1) + Stecker2)	Standard	7S4SK046040021B16
	8 m	DDP	BSB 35-50 Stecker1) + Stecker2)	Standard	7S4SK086040021B16
	4 m	DDP	BSB 35-50 Stecker1) + Stecker2)	High Flex Leder	7S4SH046040021B16
	8 m	DDP	BSB 35-50 Stecker1) + Stecker2)	High Flex Leder	7S4SH086040021B16
ABITIG® 18F	4 m	DDP	BSB 35-50 Stecker1) + Stecker2)	Standard	7S4FK046040021B16
	8 m	DDP	BSB 35-50 Stecker1) + Stecker2)	Standard	7S4FK086040021B16
	4 m	DDP	BSB 35-50 Stecker1) + Stecker2)	High Flex Leder	7S4FH046040021B16
	8 m	DDP	BSB 35-50 Stecker1) + Stecker2)	High Flex Leder	7S4FH086040021B16
ABITIG® 20	4 m	DDP	BSB 35-50 Stecker1) + Stecker2)	Standard	7S5SK046040021B16
	8 m	DDP	BSB 35-50 Stecker1) + Stecker2)	Standard	7S5SK086040021B16
	4 m	DDP	BSB 35-50 Stecker1) + Stecker2)	High Flex Leder	7S5SH046040021B16
	8 m	DDP	BSB 35-50 Stecker1) + Stecker2)	High Flex Leder	7S5SH086040021B16
ABITIG® 20F	4 m	DDP	BSB 35-50 Stecker1) + Stecker2)	Standard	7S5FK046040021B16
	8 m	DDP	BSB 35-50 Stecker1) + Stecker2)	Standard	7S5FK086040021B16
	4 m	DDP	BSB 35-50 Stecker1) + Stecker2)	High Flex Leder	7S5FH046040021B16
	8 m	DDP	BSB 35-50 Stecker1) + Stecker2)	High Flex Leder	7S5FH086040021B16

Technische Änderungen vorbehalten • Verkaufspreise = unverbindliche Preisempfehlung - Angebot freibleibend • © Copyright

ABITIG®-Brennerpreisliste

passend für WIG-Stromquellen des Fabrikates „rehm“

Brennertyp	Länge	Schalterfunktion	maschinenseitiger Anschluss	Schlauchpaketausführung	Bestellnummer
ABITIG® 12-1	4 m	DDP	BSB 35-50 Stecker1) + Stecker2)	Standard	7S6SK046040021B16
	8 m	DDP	BSB 35-50 Stecker1) + Stecker2)	Standard	7S6SK086040021B16
	4 m	DDP	BSB 35-50 Stecker1) + Stecker2)	High Flex Leder	7S6SH046040021B16
	8 m	DDP	BSB 35-50 Stecker1) + Stecker2)	High Flex Leder	7S6SH086040021B16
ABITIG® 18SC	4 m	DDP	BSB 35-50 Stecker1) + Stecker2)	Standard	7S7SK046040021B16
	8 m	DDP	BSB 35-50 Stecker1) + Stecker2)	Standard	7S7SK086040021B16
	4 m	DDP	BSB 35-50 Stecker1) + Stecker2)	High Flex Leder	7S7SH046040021B16
	8 m	DDP	BSB 35-50 Stecker1) + Stecker2)	High Flex Leder	7S7SH086040021B16
ABITIG® 24W	4 m	DDP	BSB 35-50 Stecker1) + Stecker2)	Standard	7S9SK046040021B16
	8 m	DDP	BSB 35-50 Stecker1) + Stecker2)	Standard	7S9SK086040021B16
	4 m	DDP	BSB 35-50 Stecker1) + Stecker2)	High Flex Leder	7S9SH046040021B16
	8 m	DDP	BSB 35-50 Stecker1) + Stecker2)	High Flex Leder	7S9SH086040021B16
ABITIG® 450W	4 m	DDP	BSB 35-50 Stecker1) + Stecker2)	Standard	7T5SK046040121B16
	8 m	DDP	BSB 35-50 Stecker1) + Stecker2)	Standard	7T5SK086040121B16
	4 m	DDP	BSB 35-50 Stecker1) + Stecker2)	High Flex Leder	7T5SH046040121B16
	8 m	DDP	BSB 35-50 Stecker1) + Stecker2)	High Flex Leder	7T5SH086040121B16
ABITIG® 260W	4 m	DDP	BSB 35-50 Stecker1) + Stecker2)	Standard	7T7SK046040121B16
	8 m	DDP	BSB 35-50 Stecker1) + Stecker2)	Standard	7T7SK086040121B16
	4 m	DDP	BSB 35-50 Stecker1) + Stecker2)	High Flex Leder	7T7SH046040121B16
	8 m	DDP	BSB 35-50 Stecker1) + Stecker2)	High Flex Leder	7T7SH086040121B16
ABITIG® 450W SC	4 m	DDP	BSB 35-50 Stecker1) + Stecker2)	Standard	
	8 m	DDP	BSB 35-50 Stecker1) + Stecker2)	Standard	
	4 m	DDP	BSB 35-50 Stecker1) + Stecker2)	High Flex Leder	7T8SH046040121B16
	8 m	DDP	BSB 35-50 Stecker1) + Stecker2)	High Flex Leder	7T8SH086040121B16

Stecker¹⁾ = Rundsteckverbinder 7-pol.

Stecker²⁾ = Amphenol 18-pol.

ABITIG®-Brennerpreisliste

passend für WIG-Stromquellen des Fabrikates „röwac“



Brennertyp	Länge	Schalterfunktion	maschinenseitiger Anschluss	Schlauchpaketausführung	Bestellnummer
ABITIG® 9	4 m	ED	ZA - GZ Tuchel 5-pol.	Standard	7S1SK043010305A00
	8 m	ED	ZA - GZ Tuchel 5-pol.	Standard	7S1SK083010305A00
	4 m	ED	ZA - GZ Tuchel 5-pol.	High Flex Leder	7S1SH043010305A00
	8 m	ED	ZA - GZ Tuchel 5-pol.	High Flex Leder	7S1SH083010305A00
ABITIG® 9F	4 m	ED	ZA - GZ Tuchel 5-pol.	Standard	7S1FK043010305A00
	8 m	ED	ZA - GZ Tuchel 5-pol.	Standard	7S1FK083010305A00
	4 m	ED	ZA - GZ Tuchel 5-pol.	High Flex Leder	7S1FH043010305A00
	8 m	ED	ZA - GZ Tuchel 5-pol.	High Flex Leder	7S1FH083010305A00
ABITIG® 17	4 m	ED	ZA - GZ Tuchel 5-pol.	Standard	7S2SK043010305A00
	8 m	ED	ZA - GZ Tuchel 5-pol.	Standard	7S2SK083010305A00
	4 m	ED	ZA - GZ Tuchel 5-pol.	High Flex Leder	7S2SH043010305A00
	8 m	ED	ZA - GZ Tuchel 5-pol.	High Flex Leder	7S2SH083010305A00
ABITIG® 17F	4 m	ED	ZA - GZ Tuchel 5-pol.	Standard	7S2FK043010305A00
	8 m	ED	ZA - GZ Tuchel 5-pol.	Standard	7S2FK083010305A00
	4 m	ED	ZA - GZ Tuchel 5-pol.	High Flex Leder	7S2FH043010305A00
	8 m	ED	ZA - GZ Tuchel 5-pol.	High Flex Leder	7S2FH083010305A00

Technische Änderungen vorbehalten • Verkaufspreise = unverbindliche Preisempfehlung - Angebot freibleibend • © Copyright

ABITIG®-Brennerpreisliste

passend für WIG-Stromquellen des Fabrikates „röwac“

Brennertyp	Länge	Schalterfunktion	maschinenseitiger Anschluss	Schlauchpaketausführung	Bestellnummer
ABITIG® 26	4 m	ED	ZA - GZ Tuchel 5-pol.	Standard	7S3SK043010305A00
	8 m	ED	ZA - GZ Tuchel 5-pol.	Standard	7S3SK083010305A00
	4 m	ED	ZA - GZ Tuchel 5-pol.	High Flex Leder	7S3SH043010305A00
	8 m	ED	ZA - GZ Tuchel 5-pol.	High Flex Leder	7S3SH083010305A00

ABITIG® 26F	4 m	ED	ZA - GZ Tuchel 5-pol.	Standard	7S3FK043010305A00
	8 m	ED	ZA - GZ Tuchel 5-pol.	Standard	7S3FK083010305A00
	4 m	ED	ZA - GZ Tuchel 5-pol.	High Flex Leder	7S3FH043010305A00
	8 m	ED	ZA - GZ Tuchel 5-pol.	High Flex Leder	7S3FH083010305A00

ABITIG® 24G	4 m	ED	ZA - GZ Tuchel 5-pol.	Standard	7S8SK043010305A00
	8 m	ED	ZA - GZ Tuchel 5-pol.	Standard	7S8SK083010305A00
	4 m	ED	ZA - GZ Tuchel 5-pol.	High Flex Leder	7S8SH043010305A00
	8 m	ED	ZA - GZ Tuchel 5-pol.	High Flex Leder	7S8SH083010305A00

ABITIG® 200	4 m	ED	ZA - GZ Tuchel 5-pol.	Standard	7T4SK043010305A00
	8 m	ED	ZA - GZ Tuchel 5-pol.	Standard	7T4SK083010305A00
	4 m	ED	ZA - GZ Tuchel 5-pol.	High Flex Leder	7T4SH043010305A00
	8 m	ED	ZA - GZ Tuchel 5-pol.	High Flex Leder	7T4SH083010305A00

ABITIG® 200F	4 m	ED	ZA - GZ Tuchel 5-pol.	Standard	7T4FK043010305A00
	8 m	ED	ZA - GZ Tuchel 5-pol.	Standard	7T4FK083010305A00
	4 m	ED	ZA - GZ Tuchel 5-pol.	High Flex Leder	7T4FH043010305A00
	8 m	ED	ZA - GZ Tuchel 5-pol.	High Flex Leder	7T4FH083010305A00

ABITIG® 150	4 m	ED	ZA - GZ Tuchel 5-pol.	Standard	7T6SK043010305A00
	8 m	ED	ZA - GZ Tuchel 5-pol.	Standard	7T6SK083010305A00
	4 m	ED	ZA - GZ Tuchel 5-pol.	High Flex Leder	7T6SH043010305A00
	8 m	ED	ZA - GZ Tuchel 5-pol.	High Flex Leder	7T6SH083010305A00

ABITIG® 150F	4 m	ED	ZA - GZ Tuchel 5-pol.	Standard	7T6FK043010305A00
	8 m	ED	ZA - GZ Tuchel 5-pol.	Standard	7T6FK083010305A00
	4 m	ED	ZA - GZ Tuchel 5-pol.	High Flex Leder	7T6FH043010305A00
	8 m	ED	ZA - GZ Tuchel 5-pol.	High Flex Leder	7T6FH083010305A00

ABITIG®-Brennerpreisliste

passend für WIG-Stromquellen des Fabrikates „röwac“



Brennertyp	Länge	Schalterfunktion	maschinenseitiger Anschluss	Schlauchpaketausführung	Bestellnummer
ABITIG® 18	4 m	ED	ZA - WZ-0 Tuchel 5-pol.	Standard	7S4SK043010305A12
	8 m	ED	ZA - WZ-0 Tuchel 5-pol.	Standard	7S4SK083010305A12
	4 m	ED	ZA - WZ-0 Tuchel 5-pol.	High Flex Leder	7S4SH043010305A12
	8 m	ED	ZA - WZ-0 Tuchel 5-pol.	High Flex Leder	7S4SH083010305A12
ABITIG® 18F	4 m	ED	ZA - WZ-0 Tuchel 5-pol.	Standard	7S4FK043010305A12
	8 m	ED	ZA - WZ-0 Tuchel 5-pol.	Standard	7S4FK083010305A12
	4 m	ED	ZA - WZ-0 Tuchel 5-pol.	High Flex Leder	7S4FH043010305A12
	8 m	ED	ZA - WZ-0 Tuchel 5-pol.	High Flex Leder	7S4FH083010305A12
ABITIG® 20	4 m	ED	ZA - WZ-0 Tuchel 5-pol.	Standard	7S5SK043010305A12
	8 m	ED	ZA - WZ-0 Tuchel 5-pol.	Standard	7S5SK083010305A12
	4 m	ED	ZA - WZ-0 Tuchel 5-pol.	High Flex Leder	7S5SH043010305A12
	8 m	ED	ZA - WZ-0 Tuchel 5-pol.	High Flex Leder	7S5SH083010305A12
ABITIG® 20F	4 m	ED	ZA - WZ-0 Tuchel 5-pol.	Standard	7S5FK043010305A12
	8 m	ED	ZA - WZ-0 Tuchel 5-pol.	Standard	7S5FK083010305A12
	4 m	ED	ZA - WZ-0 Tuchel 5-pol.	High Flex Leder	7S5FH043010305A12
	8 m	ED	ZA - WZ-0 Tuchel 5-pol.	High Flex Leder	7S5FH083010305A12

Technische Änderungen vorbehalten • Verkaufspreise = unverbindliche Preisempfehlung - Angebot freibleibend • © Copyright

ABITIG®-Brennerpreisliste

passend für WIG-Stromquellen des Fabrikates „röwac“

Brennertyp	Länge	Schalterfunktion	maschinenseitiger Anschluss	Schlauchpaketausführung	Bestellnummer
ABITIG® 12-1	4 m	ED	ZA - WZ-0 Tuchel 5-pol.	Standard	7S6SK043010305A12
	8 m	ED	ZA - WZ-0 Tuchel 5-pol.	Standard	7S6SK083010305A12
	4 m	ED	ZA - WZ-0 Tuchel 5-pol.	High Flex Leder	7S6SH043010305A12
	8 m	ED	ZA - WZ-0 Tuchel 5-pol.	High Flex Leder	7S6SH083010305A12
<hr/>					
ABITIG® 18SC	4 m	ED	ZA - WZ-0 Tuchel 5-pol.	Standard	7S7SK043010305A12
	8 m	ED	ZA - WZ-0 Tuchel 5-pol.	Standard	7S7SK083010305A12
	4 m	ED	ZA - WZ-0 Tuchel 5-pol.	High Flex Leder	7S7SH043010305A12
	8 m	ED	ZA - WZ-0 Tuchel 5-pol.	High Flex Leder	7S7SH083010305A12
<hr/>					
ABITIG® 24W	4 m	ED	ZA - WZ-0 Tuchel 5-pol.	Standard	7S9SK043010305A12
	8 m	ED	ZA - WZ-0 Tuchel 5-pol.	Standard	7S9SK083010305A12
	4 m	ED	ZA - WZ-0 Tuchel 5-pol.	High Flex Leder	7S9SH043010305A12
	8 m	ED	ZA - WZ-0 Tuchel 5-pol.	High Flex Leder	7S9SH083010305A12
<hr/>					
ABITIG® 450W	4 m	ED	ZA - WZ-0 Tuchel 5-pol.	Standard	7T5SK043010305A12
	8 m	ED	ZA - WZ-0 Tuchel 5-pol.	Standard	7T5SK083010305A12
	4 m	ED	ZA - WZ-0 Tuchel 5-pol.	High Flex Leder	7T5SH043010305A12
	8 m	ED	ZA - WZ-0 Tuchel 5-pol.	High Flex Leder	7T5SH083010305A12
<hr/>					
ABITIG® 260W	4 m	ED	ZA - WZ-0 Tuchel 5-pol.	Standard	7T7SK043010305A12
	8 m	ED	ZA - WZ-0 Tuchel 5-pol.	Standard	7T7SK083010305A12
	4 m	ED	ZA - WZ-0 Tuchel 5-pol.	High Flex Leder	7T7SH043010305A12
	8 m	ED	ZA - WZ-0 Tuchel 5-pol.	High Flex Leder	7T7SH083010305A12
<hr/>					
ABITIG® 450W SC	4 m	ED	ZA - WZ-0 Tuchel 5-pol.	Standard	
	8 m	ED	ZA - WZ-0 Tuchel 5-pol.	Standard	
	4 m	ED	ZA - WZ-0 Tuchel 5-pol.	High Flex Leder	7T8SH043010305A12
	8 m	ED	ZA - WZ-0 Tuchel 5-pol.	High Flex Leder	7T8SH083010305A12

ABITIG®-Brennerpreisliste

passend für WIG-Stromquellen des Fabrikates „röwac/röwig“

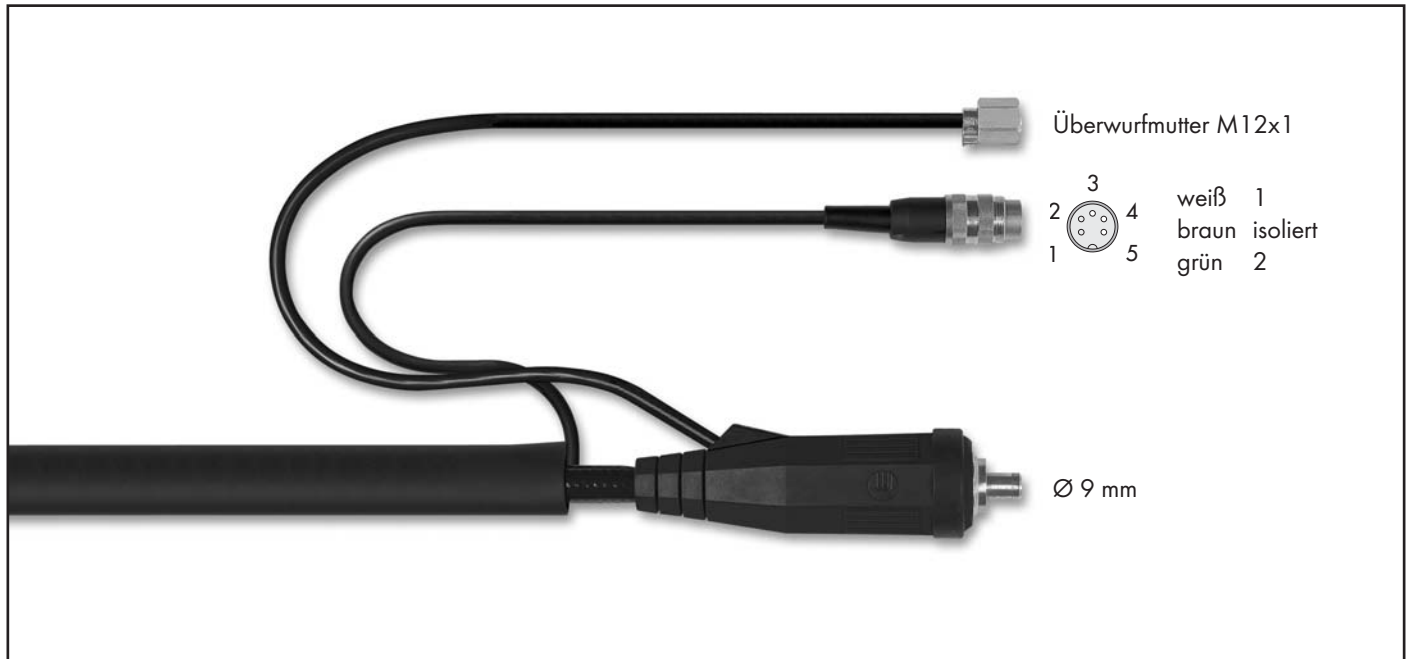

Brennertyp	Länge	Schalterfunktion	maschinenseitiger Anschluss	Schlauchpaketausführung	Bestellnummer
ABITIG® 9	4 m	ED	BSB 10-25 Kabelstecker 5-pol.	Standard	7S1SK043012240A09
	8 m	ED	BSB 10-25 Kabelstecker 5-pol.	Standard	7S1SK083012240A09
	4 m	ED	BSB 10-25 Kabelstecker 5-pol.	High Flex Leder	7S1SH043012240A09
	8 m	ED	BSB 10-25 Kabelstecker 5-pol.	High Flex Leder	7S1SH083012240A09
ABITIG® 9F	4 m	ED	BSB 10-25 Kabelstecker 5-pol.	Standard	7S1FK043012240A09
	8 m	ED	BSB 10-25 Kabelstecker 5-pol.	Standard	7S1FK083012240A09
	4 m	ED	BSB 10-25 Kabelstecker 5-pol.	High Flex Leder	7S1FH043012240A09
	8 m	ED	BSB 10-25 Kabelstecker 5-pol.	High Flex Leder	7S1FH083012240A09
ABITIG® 17	4 m	ED	BSB 10-25 Kabelstecker 5-pol.	Standard	7S2SK043012240A09
	8 m	ED	BSB 10-25 Kabelstecker 5-pol.	Standard	7S2SK083012240A09
	4 m	ED	BSB 10-25 Kabelstecker 5-pol.	High Flex Leder	7S2SH043012240A09
	8 m	ED	BSB 10-25 Kabelstecker 5-pol.	High Flex Leder	7S2SH083012240A09
ABITIG® 17F	4 m	ED	BSB 10-25 Kabelstecker 5-pol.	Standard	7S2FK043012240A09
	8 m	ED	BSB 10-25 Kabelstecker 5-pol.	Standard	7S2FK083012240A09
	4 m	ED	BSB 10-25 Kabelstecker 5-pol.	High Flex Leder	7S2FH043012240A09
	8 m	ED	BSB 10-25 Kabelstecker 5-pol.	High Flex Leder	7S2FH083012240A09

Technische Änderungen vorbehalten • Verkaufspreise = unverbindliche Preisempfehlung - Angebot freibleibend • © Copyright

ABITIG®-Brennerpreisliste

passend für WIG-Stromquellen des Fabrikates „röwac/röwig“

Brennertyp	Länge	Schalterfunktion	maschinenseitiger Anschluss	Schlauchpaketausführung	Bestellnummer
ABITIG® 26	4 m	ED	BSB 10-25 Kabelstecker 5-pol.	Standard	7S3SK043012240A09
	8 m	ED	BSB 10-25 Kabelstecker 5-pol.	Standard	7S3SK083012240A09
	4 m	ED	BSB 10-25 Kabelstecker 5-pol.	High Flex Leder	7S3SH043012240A09
	8 m	ED	BSB 10-25 Kabelstecker 5-pol.	High Flex Leder	7S3SH083012240A09
ABITIG® 26F	4 m	ED	BSB 10-25 Kabelstecker 5-pol.	Standard	7S3FK043012240A09
	8 m	ED	BSB 10-25 Kabelstecker 5-pol.	Standard	7S3FK083012240A09
	4 m	ED	BSB 10-25 Kabelstecker 5-pol.	High Flex Leder	7S3FH043012240A09
	8 m	ED	BSB 10-25 Kabelstecker 5-pol.	High Flex Leder	7S3FH083012240A09
ABITIG® 24G	4 m	ED	BSB 10-25 Kabelstecker 5-pol.	Standard	7S8SK043012240A09
	8 m	ED	BSB 10-25 Kabelstecker 5-pol.	Standard	7S8SK083012240A09
	4 m	ED	BSB 10-25 Kabelstecker 5-pol.	High Flex Leder	7S8SH043012240A09
	8 m	ED	BSB 10-25 Kabelstecker 5-pol.	High Flex Leder	7S8SH083012240A09
ABITIG® 200	4 m	ED	BSB 10-25 Kabelstecker 5-pol.	Standard	7T4SK043012240A09
	8 m	ED	BSB 10-25 Kabelstecker 5-pol.	Standard	7T4SK083012240A09
	4 m	ED	BSB 10-25 Kabelstecker 5-pol.	High Flex Leder	7T4SH043012240A09
	8 m	ED	BSB 10-25 Kabelstecker 5-pol.	High Flex Leder	7T4SH083012240A09
ABITIG® 200F	4 m	ED	BSB 10-25 Kabelstecker 5-pol.	Standard	7T4FK043012240A09
	8 m	ED	BSB 10-25 Kabelstecker 5-pol.	Standard	7T4FK083012240A09
	4 m	ED	BSB 10-25 Kabelstecker 5-pol.	High Flex Leder	7T4FH043012240A09
	8 m	ED	BSB 10-25 Kabelstecker 5-pol.	High Flex Leder	7T4FH083012240A09
ABITIG® 150	4 m	ED	BSB 10-25 Kabelstecker 5-pol.	Standard	7T6SK043012240A09
	8 m	ED	BSB 10-25 Kabelstecker 5-pol.	Standard	7T6SK083012240A09
	4 m	ED	BSB 10-25 Kabelstecker 5-pol.	High Flex Leder	7T6SH043012240A09
	8 m	ED	BSB 10-25 Kabelstecker 5-pol.	High Flex Leder	7T6SH083012240A09
ABITIG® 150F	4 m	ED	BSB 10-25 Kabelstecker 5-pol.	Standard	7T6FK043012240A09
	8 m	ED	BSB 10-25 Kabelstecker 5-pol.	Standard	7T6FK083012240A09
	4 m	ED	BSB 10-25 Kabelstecker 5-pol.	High Flex Leder	7T6FH043012240A09
	8 m	ED	BSB 10-25 Kabelstecker 5-pol.	High Flex Leder	7T6FH083012240A09

ABITIG®-Brennerpreisliste

passend für WIG-Stromquellen des Fabrikates „röwac/röwig“

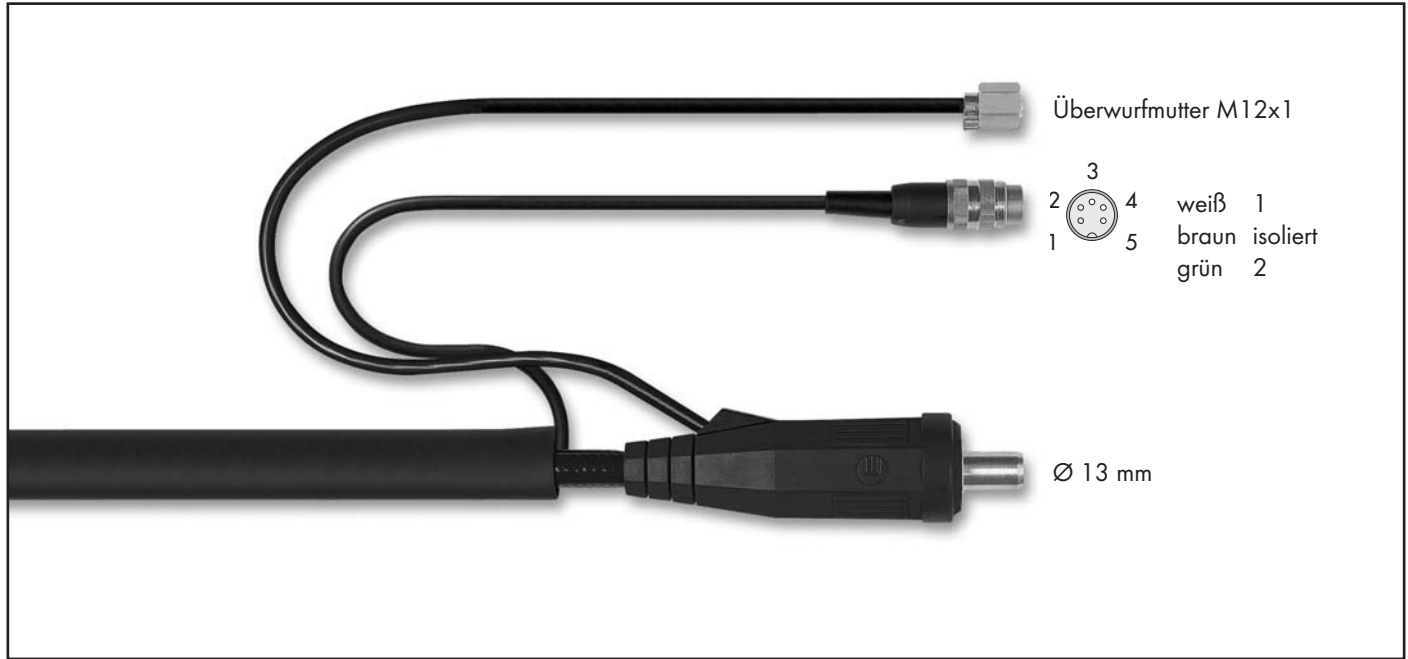

Brennertyp	Länge	Schalterfunktion	maschinenseitiger Anschluss	Schlauchpaketausführung	Bestellnummer
ABITIG® 9	4 m	ED	BSB 35-50 Kabelstecker 5-pol.	Standard	7S1SK043010040A09
	8 m	ED	BSB 35-50 Kabelstecker 5-pol.	Standard	7S1SK083010040A09
	4 m	ED	BSB 35-50 Kabelstecker 5-pol.	High Flex Leder	7S1SH043010040A09
	8 m	ED	BSB 35-50 Kabelstecker 5-pol.	High Flex Leder	7S1SH083010040A09
ABITIG® 9F	4 m	ED	BSB 35-50 Kabelstecker 5-pol.	Standard	7S1FK043010040A09
	8 m	ED	BSB 35-50 Kabelstecker 5-pol.	Standard	7S1FK083010040A09
	4 m	ED	BSB 35-50 Kabelstecker 5-pol.	High Flex Leder	7S1FH043010040A09
	8 m	ED	BSB 35-50 Kabelstecker 5-pol.	High Flex Leder	7S1FH083010040A09
ABITIG® 17	4 m	ED	BSB 35-50 Kabelstecker 5-pol.	Standard	7S2SK043010040A09
	8 m	ED	BSB 35-50 Kabelstecker 5-pol.	Standard	7S2SK083010040A09
	4 m	ED	BSB 35-50 Kabelstecker 5-pol.	High Flex Leder	7S2SH043010040A09
	8 m	ED	BSB 35-50 Kabelstecker 5-pol.	High Flex Leder	7S2SH083010040A09
ABITIG® 17F	4 m	ED	BSB 35-50 Kabelstecker 5-pol.	Standard	7S2FK043010040A09
	8 m	ED	BSB 35-50 Kabelstecker 5-pol.	Standard	7S2FK083010040A09
	4 m	ED	BSB 35-50 Kabelstecker 5-pol.	High Flex Leder	7S2FH043010040A09
	8 m	ED	BSB 35-50 Kabelstecker 5-pol.	High Flex Leder	7S2FH083010040A09

Technische Änderungen vorbehalten • Verkaufspreise = unverbindliche Preisempfehlung - Angebot freibleibend • © Copyright

ABITIG®-Brennerpreisliste

passend für WIG-Stromquellen des Fabrikates „röwac/röwig“

Brennertyp	Länge	Schalterfunktion	maschinenseitiger Anschluss	Schlauchpaketausführung	Bestellnummer
ABITIG® 26	4 m	ED	BSB 35-50 Kabelstecker 5-pol.	Standard	7S3SK043010040A09
	8 m	ED	BSB 35-50 Kabelstecker 5-pol.	Standard	7S3SK083010040A09
	4 m	ED	BSB 35-50 Kabelstecker 5-pol.	High Flex Leder	7S3SH043010040A09
	8 m	ED	BSB 35-50 Kabelstecker 5-pol.	High Flex Leder	7S3SH083010040A09
ABITIG® 26F	4 m	ED	BSB 35-50 Kabelstecker 5-pol.	Standard	7S3FK043010040A09
	8 m	ED	BSB 35-50 Kabelstecker 5-pol.	Standard	7S3FK083010040A09
	4 m	ED	BSB 35-50 Kabelstecker 5-pol.	High Flex Leder	7S3FH043010040A09
	8 m	ED	BSB 35-50 Kabelstecker 5-pol.	High Flex Leder	7S3FH083010040A09
ABITIG® 24G	4 m	ED	BSB 35-50 Kabelstecker 5-pol.	Standard	7S8SK043010040A09
	8 m	ED	BSB 35-50 Kabelstecker 5-pol.	Standard	7S8SK083010040A09
	4 m	ED	BSB 35-50 Kabelstecker 5-pol.	High Flex Leder	7S8SH043010040A09
	8 m	ED	BSB 35-50 Kabelstecker 5-pol.	High Flex Leder	7S8SH083010040A09
ABITIG® 200	4 m	ED	BSB 35-50 Kabelstecker 5-pol.	Standard	7T4SK043010040A09
	8 m	ED	BSB 35-50 Kabelstecker 5-pol.	Standard	7T4SK083010040A09
	4 m	ED	BSB 35-50 Kabelstecker 5-pol.	High Flex Leder	7T4SH043010040A09
	8 m	ED	BSB 35-50 Kabelstecker 5-pol.	High Flex Leder	7T4SH083010040A09
ABITIG® 200F	4 m	ED	BSB 35-50 Kabelstecker 5-pol.	Standard	7T4FK043010040A09
	8 m	ED	BSB 35-50 Kabelstecker 5-pol.	Standard	7T4FK083010040A09
	4 m	ED	BSB 35-50 Kabelstecker 5-pol.	High Flex Leder	7T4FH043010040A09
	8 m	ED	BSB 35-50 Kabelstecker 5-pol.	High Flex Leder	7T4FH083010040A09
ABITIG® 150	4 m	ED	BSB 35-50 Kabelstecker 5-pol.	Standard	7T6SK043010040A09
	8 m	ED	BSB 35-50 Kabelstecker 5-pol.	Standard	7T6SK083010040A09
	4 m	ED	BSB 35-50 Kabelstecker 5-pol.	High Flex Leder	7T6SH043010040A09
	8 m	ED	BSB 35-50 Kabelstecker 5-pol.	High Flex Leder	7T6SH083010040A09
ABITIG® 150F	4 m	ED	BSB 35-50 Kabelstecker 5-pol.	Standard	7T6FK043010040A09
	8 m	ED	BSB 35-50 Kabelstecker 5-pol.	Standard	7T6FK083010040A09
	4 m	ED	BSB 35-50 Kabelstecker 5-pol.	High Flex Leder	7T6FH043010040A09
	8 m	ED	BSB 35-50 Kabelstecker 5-pol.	High Flex Leder	7T6FH083010040A09

ABITIG®-Brennerpreisliste

passend für WIG-Stromquellen des Fabrikates „röwac/röwig“

Nur Röwig 180 DC und 180 AC/DC



Brennertyp	Länge	Schalterfunktion	maschinenseitiger Anschluss	Schlauchpaketausführung	Bestellnummer
ABITIG® 9	4 m	ED	ZA 9-pol.	Standard	7S1SK043010797D00
	8 m	ED	ZA 9-pol.	Standard	7S1SK083010797D00
	4 m	ED	ZA 9-pol.	High Flex Leder	7S1SH043010797D00
	8 m	ED	ZA 9-pol.	High Flex Leder	7S1SH083010797D00

ABITIG® 9F	4 m	ED	ZA 9-pol.	Standard	7S1FK043010797D00
	8 m	ED	ZA 9-pol.	Standard	7S1FK083010797D00
	4 m	ED	ZA 9-pol.	High Flex Leder	7S1FH043010797D00
	8 m	ED	ZA 9-pol.	High Flex Leder	7S1FH083010797D00

ABITIG® 17	4 m	ED	ZA 9-pol.	Standard	7S2SK043010797D00
	8 m	ED	ZA 9-pol.	Standard	7S2SK083010797D00
	4 m	ED	ZA 9-pol.	High Flex Leder	7S2SH043010797D00
	8 m	ED	ZA 9-pol.	High Flex Leder	7S2SH083010797D00

ABITIG® 17F	4 m	ED	ZA 9-pol.	Standard	7S2FK043010797D00
	8 m	ED	ZA 9-pol.	Standard	7S2FK083010797D00
	4 m	ED	ZA 9-pol.	High Flex Leder	7S2FH043010797D00
	8 m	ED	ZA 9-pol.	High Flex Leder	7S2FH083010797D00

ABITIG®-Brennerpreisliste

passend für WIG-Stromquellen des Fabrikates „röwac/röwig“

Brennertyp	Länge	Schalterfunktion	maschinenseitiger Anschluss	Schlauchpaketausführung	Bestellnummer
ABITIG® 26	4 m	ED	ZA 9-pol.	Standard	7S3SK043010797D00
	8 m	ED	ZA 9-pol.	Standard	7S3SK083010797D00
	4 m	ED	ZA 9-pol.	High Flex Leder	7S3SH043010797D00
	8 m	ED	ZA 9-pol.	High Flex Leder	7S3SH083010797D00

ABITIG® 26F	4 m	ED	ZA 9-pol.	Standard	7S3FK043010797D00
	8 m	ED	ZA 9-pol.	Standard	7S3FK083010797D00
	4 m	ED	ZA 9-pol.	High Flex Leder	7S3FH043010797D00
	8 m	ED	ZA 9-pol.	High Flex Leder	7S3FH083010797D00

ABITIG® 24G	4 m	ED	ZA 9-pol.	Standard	7S8SK043010797D00
	8 m	ED	ZA 9-pol.	Standard	7S8SK083010797D00
	4 m	ED	ZA 9-pol.	High Flex Leder	7S8SH043010797D00
	8 m	ED	ZA 9-pol.	High Flex Leder	7S8SH083010797D00

ABITIG® 200	4 m	ED	ZA 9-pol.	Standard	7T4SK043010797D00
	8 m	ED	ZA 9-pol.	Standard	7T4SK083010797D00
	4 m	ED	ZA 9-pol.	High Flex Leder	7T4SH043010797D00
	8 m	ED	ZA 9-pol.	High Flex Leder	7T4SH083010797D00

ABITIG® 200F	4 m	ED	ZA 9-pol.	Standard	7T4FK043010797D00
	8 m	ED	ZA 9-pol.	Standard	7T4FK083010797D00
	4 m	ED	ZA 9-pol.	High Flex Leder	7T4FH043010797D00
	8 m	ED	ZA 9-pol.	High Flex Leder	7T4FH083010797D00

ABITIG® 150	4 m	ED	ZA 9-pol.	Standard	7T6SK043010797D00
	8 m	ED	ZA 9-pol.	Standard	7T6SK083010797D00
	4 m	ED	ZA 9-pol.	High Flex Leder	7T6SH043010797D00
	8 m	ED	ZA 9-pol.	High Flex Leder	7T6SH083010797D00

ABITIG® 150F	4 m	ED	ZA 9-pol.	Standard	7T6FK043010797D00
	8 m	ED	ZA 9-pol.	Standard	7T6FK083010797D00
	4 m	ED	ZA 9-pol.	High Flex Leder	7T6FH043010797D00
	8 m	ED	ZA 9-pol.	High Flex Leder	7T6FH083010797D00

ABITIG®-Brennerpreisliste

passend für WIG-Stromquellen des Fabrikates „röwac/röwig“



Brennertyp	Länge	Schalterfunktion	maschinenseitiger Anschluss	Schlauchpaketausführung	Bestellnummer
ABITIG® 9	4 m	ED	ZA 9-pol.	Standard	7S1SK043010797C00
	8 m	ED	ZA 9-pol.	Standard	7S1SK083010797C00
	4 m	ED	ZA 9-pol.	High Flex Leder	7S1SH043010797C00
	8 m	ED	ZA 9-pol.	High Flex Leder	7S1SH083010797C00
ABITIG® 9F	4 m	ED	ZA 9-pol.	Standard	7S1FK043010797C00
	8 m	ED	ZA 9-pol.	Standard	7S1FK083010797C00
	4 m	ED	ZA 9-pol.	High Flex Leder	7S1FH043010797C00
	8 m	ED	ZA 9-pol.	High Flex Leder	7S1FH083010797C00
ABITIG® 17	4 m	ED	ZA 9-pol.	Standard	7S2SK043010797C00
	8 m	ED	ZA 9-pol.	Standard	7S2SK083010797C00
	4 m	ED	ZA 9-pol.	High Flex Leder	7S2SH043010797C00
	8 m	ED	ZA 9-pol.	High Flex Leder	7S2SH083010797C00
ABITIG® 17F	4 m	ED	ZA 9-pol.	Standard	7S2FK043010797C00
	8 m	ED	ZA 9-pol.	Standard	7S2FK083010797C00
	4 m	ED	ZA 9-pol.	High Flex Leder	7S2FH043010797C00
	8 m	ED	ZA 9-pol.	High Flex Leder	7S2FH083010797C00

Technische Änderungen vorbehalten • Verkaufspreise = unverbindliche Preisempfehlung - Angebot freibleibend • © Copyright

ABITIG®-Brennerpreisliste

passend für WIG-Stromquellen des Fabrikates „röwac/röwig“

Brennertyp	Länge	Schalterfunktion	maschinenseitiger Anschluss	Schlauchpaketausführung	Bestellnummer
ABITIG® 26	4 m	ED	ZA 9-pol.	Standard	7S3SK043010797C00
	8 m	ED	ZA 9-pol.	Standard	7S3SK083010797C00
	4 m	ED	ZA 9-pol.	High Flex Leder	7S3SH043010797C00
	8 m	ED	ZA 9-pol.	High Flex Leder	7S3SH083010797C00
ABITIG® 26F	4 m	ED	ZA 9-pol.	Standard	7S3FK043010797C00
	8 m	ED	ZA 9-pol.	Standard	7S3FK083010797C00
	4 m	ED	ZA 9-pol.	High Flex Leder	7S3FH043010797C00
	8 m	ED	ZA 9-pol.	High Flex Leder	7S3FH083010797C00
ABITIG® 24G	4 m	ED	ZA 9-pol.	Standard	7S8SK043010797C00
	8 m	ED	ZA 9-pol.	Standard	7S8SK083010797C00
	4 m	ED	ZA 9-pol.	High Flex Leder	7S8SH043010797C00
	8 m	ED	ZA 9-pol.	High Flex Leder	7S8SH083010797C00
ABITIG® 200	4 m	ED	ZA 9-pol.	Standard	7T4SK043010797C00
	8 m	ED	ZA 9-pol.	Standard	7T4SK083010797C00
	4 m	ED	ZA 9-pol.	High Flex Leder	7T4SH043010797C00
	8 m	ED	ZA 9-pol.	High Flex Leder	7T4SH083010797C00
ABITIG® 200F	4 m	ED	ZA 9-pol.	Standard	7T4FK043010797C00
	8 m	ED	ZA 9-pol.	Standard	7T4FK083010797C00
	4 m	ED	ZA 9-pol.	High Flex Leder	7T4FH043010797C00
	8 m	ED	ZA 9-pol.	High Flex Leder	7T4FH083010797C00
ABITIG® 150	4 m	ED	ZA 9-pol.	Standard	7T6SK043010797C00
	8 m	ED	ZA 9-pol.	Standard	7T6SK083010797C00
	4 m	ED	ZA 9-pol.	High Flex Leder	7T6SH043010797C00
	8 m	ED	ZA 9-pol.	High Flex Leder	7T6SH083010797C00
ABITIG® 150F	4 m	ED	ZA 9-pol.	Standard	7T6FK043010797C00
	8 m	ED	ZA 9-pol.	Standard	7T6FK083010797C00
	4 m	ED	ZA 9-pol.	High Flex Leder	7T6FH043010797C00
	8 m	ED	ZA 9-pol.	High Flex Leder	7T6FH083010797C00

ABITIG®-Brennerpreisliste

passend für WIG-Stromquellen des Fabrikates „rs welding systems“

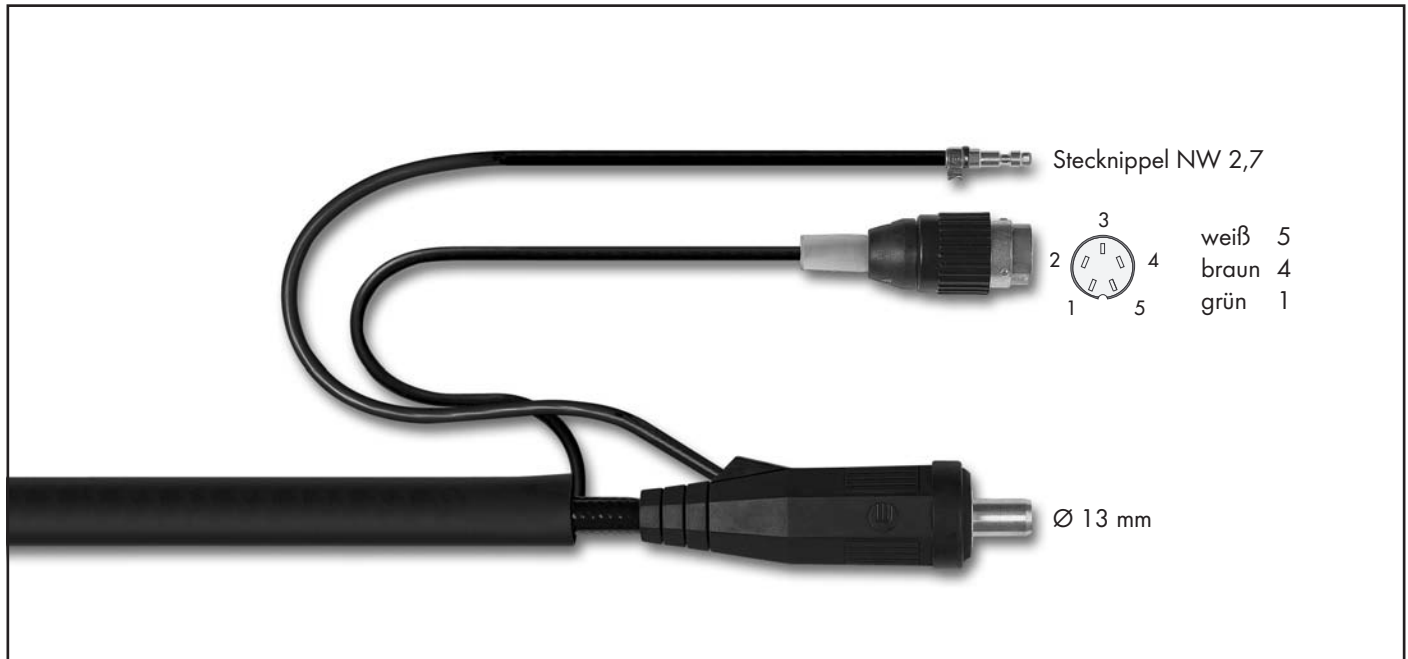

Brennertyp	Länge	Schalterfunktion	maschinenseitiger Anschluss	Schlauchpaketausführung	Bestellnummer
ABITIG® 9	4 m	DD	BSB 35-50 Tuchel 5-pol.	Standard	7S1SK043020050A04
	8 m	DD	BSB 35-50 Tuchel 5-pol.	Standard	7S1SK083020050A04
	4 m	DD	BSB 35-50 Tuchel 5-pol.	High Flex Leder	7S1SH043020050A04
	8 m	DD	BSB 35-50 Tuchel 5-pol.	High Flex Leder	7S1SH083020050A04

ABITIG® 9F	4 m	DD	BSB 35-50 Tuchel 5-pol.	Standard	7S1FK043020050A04
	8 m	DD	BSB 35-50 Tuchel 5-pol.	Standard	7S1FK083020050A04
	4 m	DD	BSB 35-50 Tuchel 5-pol.	High Flex Leder	7S1FH043020050A04
	8 m	DD	BSB 35-50 Tuchel 5-pol.	High Flex Leder	7S1FH083020050A04

ABITIG® 17	4 m	DD	BSB 35-50 Tuchel 5-pol.	Standard	7S2SK043020050A04
	8 m	DD	BSB 35-50 Tuchel 5-pol.	Standard	7S2SK083020050A04
	4 m	DD	BSB 35-50 Tuchel 5-pol.	High Flex Leder	7S2SH043020050A04
	8 m	DD	BSB 35-50 Tuchel 5-pol.	High Flex Leder	7S2SH083020050A04

ABITIG® 17F	4 m	DD	BSB 35-50 Tuchel 5-pol.	Standard	7S2FK043020050A04
	8 m	DD	BSB 35-50 Tuchel 5-pol.	Standard	7S2FK083020050A04
	4 m	DD	BSB 35-50 Tuchel 5-pol.	High Flex Leder	7S2FH043020050A04
	8 m	DD	BSB 35-50 Tuchel 5-pol.	High Flex Leder	7S2FH083020050A04

Technische Änderungen vorbehalten • Verkaufspreise = unverbindliche Preisempfehlung - Angebot freibleibend • © Copyright

ABITIG®-Brennerpreisliste

passend für WIG-Stromquellen des Fabrikates „rs welding systems“

Brennertyp	Länge	Schalterfunktion	maschinenseitiger Anschluss	Schlauchpaketausführung	Bestellnummer
ABITIG® 26	4 m	DD	BSB 35-50 Tuchel 5-pol.	Standard	7S3SK043020050A04
	8 m	DD	BSB 35-50 Tuchel 5-pol.	Standard	7S3SK083020050A04
	4 m	DD	BSB 35-50 Tuchel 5-pol.	High Flex Leder	7S3SH043020050A04
	8 m	DD	BSB 35-50 Tuchel 5-pol.	High Flex Leder	7S3SH083020050A04
ABITIG® 26F	4 m	DD	BSB 35-50 Tuchel 5-pol.	Standard	7S3FK043020050A04
	8 m	DD	BSB 35-50 Tuchel 5-pol.	Standard	7S3FK083020050A04
	4 m	DD	BSB 35-50 Tuchel 5-pol.	High Flex Leder	7S3FH043020050A04
	8 m	DD	BSB 35-50 Tuchel 5-pol.	High Flex Leder	7S3FH083020050A04
ABITIG® 24G	4 m	DD	BSB 35-50 Tuchel 5-pol.	Standard	7S8SK043020050A04
	8 m	DD	BSB 35-50 Tuchel 5-pol.	Standard	7S8SK083020050A04
	4 m	DD	BSB 35-50 Tuchel 5-pol.	High Flex Leder	7S8SH043020050A04
	8 m	DD	BSB 35-50 Tuchel 5-pol.	High Flex Leder	7S8SH083020050A04
ABITIG® 200	4 m	DD	BSB 35-50 Tuchel 5-pol.	Standard	7T4SK043020050A04
	8 m	DD	BSB 35-50 Tuchel 5-pol.	Standard	7T4SK083020050A04
	4 m	DD	BSB 35-50 Tuchel 5-pol.	High Flex Leder	7T4SH043020050A04
	8 m	DD	BSB 35-50 Tuchel 5-pol.	High Flex Leder	7T4SH083020050A04
ABITIG® 200F	4 m	DD	BSB 35-50 Tuchel 5-pol.	Standard	7T4FK043020050A04
	8 m	DD	BSB 35-50 Tuchel 5-pol.	Standard	7T4FK083020050A04
	4 m	DD	BSB 35-50 Tuchel 5-pol.	High Flex Leder	7T4FH043020050A04
	8 m	DD	BSB 35-50 Tuchel 5-pol.	High Flex Leder	7T4FH083020050A04
ABITIG® 150	4 m	DD	BSB 35-50 Tuchel 5-pol.	Standard	7T6SK043020050A04
	8 m	DD	BSB 35-50 Tuchel 5-pol.	Standard	7T6SK083020050A04
	4 m	DD	BSB 35-50 Tuchel 5-pol.	High Flex Leder	7T6SH043020050A04
	8 m	DD	BSB 35-50 Tuchel 5-pol.	High Flex Leder	7T6SH083020050A04
ABITIG® 150F	4 m	DD	BSB 35-50 Tuchel 5-pol.	Standard	7T6FK043020050A04
	8 m	DD	BSB 35-50 Tuchel 5-pol.	Standard	7T6FK083020050A04
	4 m	DD	BSB 35-50 Tuchel 5-pol.	High Flex Leder	7T6FH043020050A04
	8 m	DD	BSB 35-50 Tuchel 5-pol.	High Flex Leder	7T6FH083020050A04

ABITIG®-Brennerpreisliste

passend für WIG-Stromquellen des Fabrikates „rs welding systems“

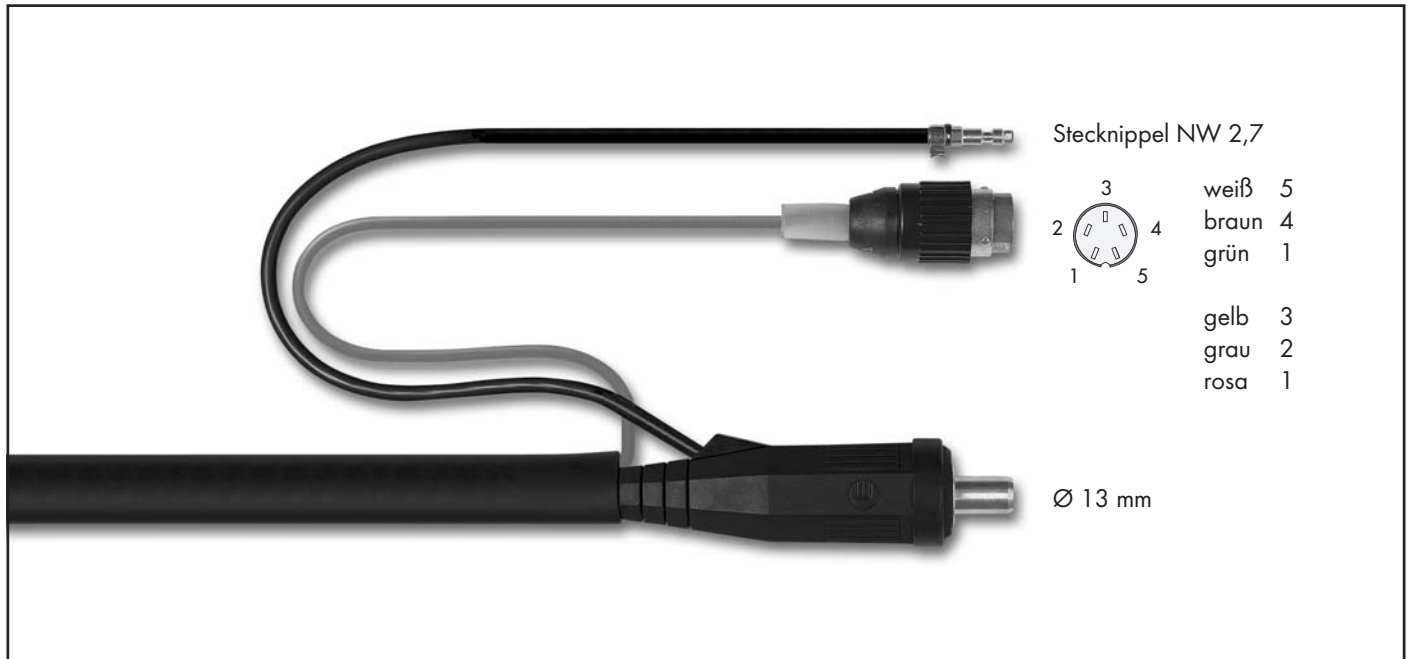

Brennertyp	Länge	Schalterfunktion	maschinenseitiger Anschluss	Schlauchpaketausführung	Bestellnummer
ABITIG® 9	4 m	DDP	BSB 35-50 Tuchel 5-pol.	Standard	7S1SK046040050B04
	8 m	DDP	BSB 35-50 Tuchel 5-pol.	Standard	7S1SK086040050B04
	4 m	DDP	BSB 35-50 Tuchel 5-pol.	High Flex Leder	7S1SH046040050B04
	8 m	DDP	BSB 35-50 Tuchel 5-pol.	High Flex Leder	7S1SH086040050B04
ABITIG® 9F	4 m	DDP	BSB 35-50 Tuchel 5-pol.	Standard	7S1FK046040050B04
	8 m	DDP	BSB 35-50 Tuchel 5-pol.	Standard	7S1FK086040050B04
	4 m	DDP	BSB 35-50 Tuchel 5-pol.	High Flex Leder	7S1FH046040050B04
	8 m	DDP	BSB 35-50 Tuchel 5-pol.	High Flex Leder	7S1FH086040050B04
ABITIG® 17	4 m	DDP	BSB 35-50 Tuchel 5-pol.	Standard	7S2SK046040050B04
	8 m	DDP	BSB 35-50 Tuchel 5-pol.	Standard	7S2SK086040050B04
	4 m	DDP	BSB 35-50 Tuchel 5-pol.	High Flex Leder	7S2SH046040050B04
	8 m	DDP	BSB 35-50 Tuchel 5-pol.	High Flex Leder	7S2SH086040050B04
ABITIG® 17F	4 m	DDP	BSB 35-50 Tuchel 5-pol.	Standard	7S2FK046040050B04
	8 m	DDP	BSB 35-50 Tuchel 5-pol.	Standard	7S2FK086040050B04
	4 m	DDP	BSB 35-50 Tuchel 5-pol.	High Flex Leder	7S2FH046040050B04
	8 m	DDP	BSB 35-50 Tuchel 5-pol.	High Flex Leder	7S2FH086040050B04

Technische Änderungen vorbehalten • Verkaufspreise = unverbindliche Preisempfehlung - Angebot freibleibend • © Copyright

ABITIG®-Brennerpreisliste

passend für WIG-Stromquellen des Fabrikates „rs welding systems“

Brennertyp	Länge	Schalterfunktion	maschinenseitiger Anschluss	Schlauchpaketausführung	Bestellnummer
ABITIG® 26	4 m	DDP	BSB 35-50 Tuchel 5-pol.	Standard	7S3SK046040050B04
	8 m	DDP	BSB 35-50 Tuchel 5-pol.	Standard	7S3SK086040050B04
	4 m	DDP	BSB 35-50 Tuchel 5-pol.	High Flex Leder	7S3SH046040050B04
	8 m	DDP	BSB 35-50 Tuchel 5-pol.	High Flex Leder	7S3SH086040050B04
ABITIG® 26F	4 m	DDP	BSB 35-50 Tuchel 5-pol.	Standard	7S3FK046040050B04
	8 m	DDP	BSB 35-50 Tuchel 5-pol.	Standard	7S3FK086040050B04
	4 m	DDP	BSB 35-50 Tuchel 5-pol.	High Flex Leder	7S3FH046040050B04
	8 m	DDP	BSB 35-50 Tuchel 5-pol.	High Flex Leder	7S3FH086040050B04
ABITIG® 24G	4 m	DDP	BSB 35-50 Tuchel 5-pol.	Standard	7S8SK046040050B04
	8 m	DDP	BSB 35-50 Tuchel 5-pol.	Standard	7S8SK086040050B04
	4 m	DDP	BSB 35-50 Tuchel 5-pol.	High Flex Leder	7S8SH046040050B04
	8 m	DDP	BSB 35-50 Tuchel 5-pol.	High Flex Leder	7S8SH086040050B04
ABITIG® 200	4 m	DDP	BSB 35-50 Tuchel 5-pol.	Standard	7T4SK046040050B04
	8 m	DDP	BSB 35-50 Tuchel 5-pol.	Standard	7T4SK086040050B04
	4 m	DDP	BSB 35-50 Tuchel 5-pol.	High Flex Leder	7T4SH046040050B04
	8 m	DDP	BSB 35-50 Tuchel 5-pol.	High Flex Leder	7T4SH086040050B04
ABITIG® 200F	4 m	DDP	BSB 35-50 Tuchel 5-pol.	Standard	7T4FK046040050B04
	8 m	DDP	BSB 35-50 Tuchel 5-pol.	Standard	7T4FK086040050B04
	4 m	DDP	BSB 35-50 Tuchel 5-pol.	High Flex Leder	7T4FH046040050B04
	8 m	DDP	BSB 35-50 Tuchel 5-pol.	High Flex Leder	7T4FH086040050B04
ABITIG® 150	4 m	DDP	BSB 35-50 Tuchel 5-pol.	Standard	7T6SK046040050B04
	8 m	DDP	BSB 35-50 Tuchel 5-pol.	Standard	7T6SK086040050B04
	4 m	DDP	BSB 35-50 Tuchel 5-pol.	High Flex Leder	7T6SH046040050B04
	8 m	DDP	BSB 35-50 Tuchel 5-pol.	High Flex Leder	7T6SH086040050B04
ABITIG® 150F	4 m	DDP	BSB 35-50 Tuchel 5-pol.	Standard	7T6FK046040050B04
	8 m	DDP	BSB 35-50 Tuchel 5-pol.	Standard	7T6FK086040050B04
	4 m	DDP	BSB 35-50 Tuchel 5-pol.	High Flex Leder	7T6FH046040050B04
	8 m	DDP	BSB 35-50 Tuchel 5-pol.	High Flex Leder	7T6FH086040050B04

ABITIG®-Brennerpreisliste

passend für WIG-Stromquellen des Fabrikates „rs welding systems“

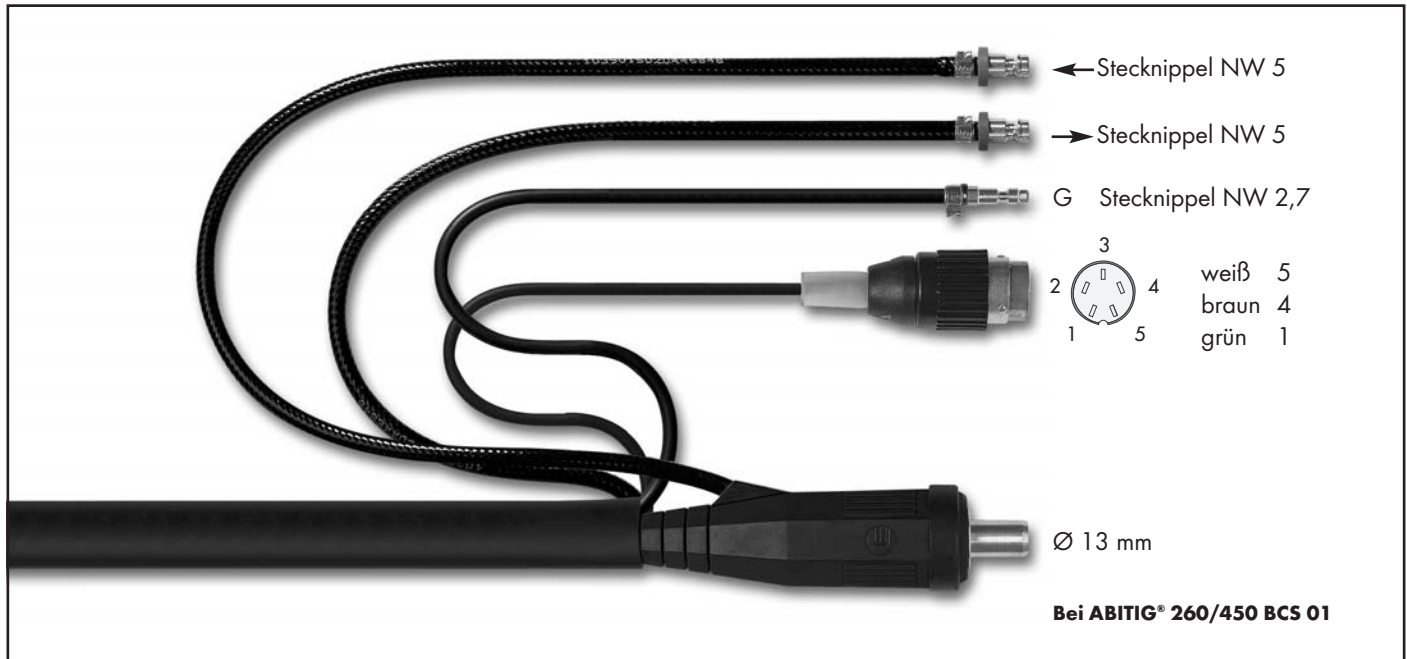

Brennertyp	Länge	Schalterfunktion	maschinenseitiger Anschluss	Schlauchpaketausführung	Bestellnummer
ABITIG® 18	4 m	DD	BSB 35-50 Tuchel 5-pol.	Standard	7S4SK043020050A22
	8 m	DD	BSB 35-50 Tuchel 5-pol.	Standard	7S4SK083020050A22
	4 m	DD	BSB 35-50 Tuchel 5-pol.	High Flex Leder	7S4SH043020050A22
	8 m	DD	BSB 35-50 Tuchel 5-pol.	High Flex Leder	7S4SH083020050A22
ABITIG® 18F	4 m	DD	BSB 35-50 Tuchel 5-pol.	Standard	7S4FK043020050A22
	8 m	DD	BSB 35-50 Tuchel 5-pol.	Standard	7S4FK083020050A22
	4 m	DD	BSB 35-50 Tuchel 5-pol.	High Flex Leder	7S4FH043020050A22
	8 m	DD	BSB 35-50 Tuchel 5-pol.	High Flex Leder	7S4FH083020050A22
ABITIG® 20	4 m	DD	BSB 35-50 Tuchel 5-pol.	Standard	7S5SK043020050A22
	8 m	DD	BSB 35-50 Tuchel 5-pol.	Standard	7S5SK083020050A22
	4 m	DD	BSB 35-50 Tuchel 5-pol.	High Flex Leder	7S5SH043020050A22
	8 m	DD	BSB 35-50 Tuchel 5-pol.	High Flex Leder	7S5SH083020050A22
ABITIG® 20F	4 m	DD	BSB 35-50 Tuchel 5-pol.	Standard	7S5FK043020050A22
	8 m	DD	BSB 35-50 Tuchel 5-pol.	Standard	7S5FK083020050A22
	4 m	DD	BSB 35-50 Tuchel 5-pol.	High Flex Leder	7S5FH043020050A22
	8 m	DD	BSB 35-50 Tuchel 5-pol.	High Flex Leder	7S5FH083020050A22

Technische Änderungen vorbehalten • Verkaufspreise = unverbindliche Preisempfehlung - Angebot freibleibend • © Copyright

ABITIG®-Brennerpreisliste

passend für WIG-Stromquellen des Fabrikates „rs welding systems“

Brennertyp	Länge	Schalterfunktion	maschinenseitiger Anschluss	Schlauchpaketausführung	Bestellnummer
ABITIG® 12-1	4 m	DD	BSB 35-50 Tuchel 5-pol.	Standard	7S6SK043020050A22
	8 m	DD	BSB 35-50 Tuchel 5-pol.	Standard	7S6SK083020050A22
	4 m	DD	BSB 35-50 Tuchel 5-pol.	High Flex Leder	7S6SH043020050A22
	8 m	DD	BSB 35-50 Tuchel 5-pol.	High Flex Leder	7S6SH083020050A22
ABITIG® 18SC	4 m	DD	BSB 35-50 Tuchel 5-pol.	Standard	7S7SK043020050A22
	8 m	DD	BSB 35-50 Tuchel 5-pol.	Standard	7S7SK083020050A22
	4 m	DD	BSB 35-50 Tuchel 5-pol.	High Flex Leder	7S7SH043020050A22
	8 m	DD	BSB 35-50 Tuchel 5-pol.	High Flex Leder	7S7SH083020050A22
ABITIG® 24W	4 m	DD	BSB 35-50 Tuchel 5-pol.	Standard	7S9SK043020050A22
	8 m	DD	BSB 35-50 Tuchel 5-pol.	Standard	7S9SK083020050A22
	4 m	DD	BSB 35-50 Tuchel 5-pol.	High Flex Leder	7S9SH043020050A22
	8 m	DD	BSB 35-50 Tuchel 5-pol.	High Flex Leder	7S9SH083020050A22
ABITIG® 450W	4 m	DD	BSB 35-50 Tuchel 5-pol.	Standard	7T5SK043020150A22
	8 m	DD	BSB 35-50 Tuchel 5-pol.	Standard	7T5SK083020150A22
	4 m	DD	BSB 35-50 Tuchel 5-pol.	High Flex Leder	7T5SH043020150A22
	8 m	DD	BSB 35-50 Tuchel 5-pol.	High Flex Leder	7T5SH083020150A22
ABITIG® 260W	4 m	DD	BSB 35-50 Tuchel 5-pol.	Standard	7T7SK043020150A22
	8 m	DD	BSB 35-50 Tuchel 5-pol.	Standard	7T7SK083020150A22
	4 m	DD	BSB 35-50 Tuchel 5-pol.	High Flex Leder	7T7SH043020150A22
	8 m	DD	BSB 35-50 Tuchel 5-pol.	High Flex Leder	7T7SH083020150A22
ABITIG® 450W SC	4 m	DD	BSB 35-50 Tuchel 5-pol.	Standard	
	8 m	DD	BSB 35-50 Tuchel 5-pol.	Standard	
	4 m	DD	BSB 35-50 Tuchel 5-pol.	High Flex Leder	7T8SH043020150A22
	8 m	DD	BSB 35-50 Tuchel 5-pol.	High Flex Leder	7T8SH083020150A22

ABITIG®-Brennerpreisliste

passend für WIG-Stromquellen des Fabrikates „rs welding systems“

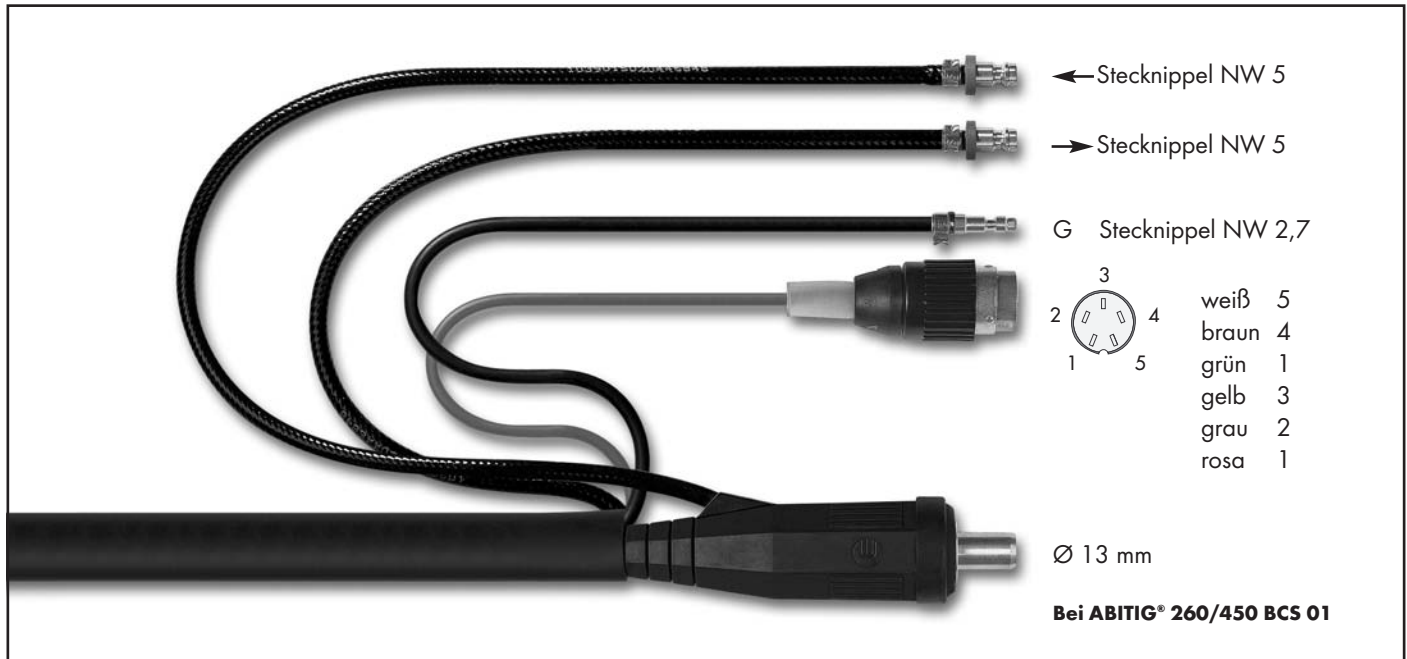

Brennertyp	Länge	Schalterfunktion	maschinenseitiger Anschluss	Schlauchpaketausführung	Bestellnummer
ABITIG® 18	4 m	DDP	BSB 35-50 Tuchel 5-pol.	Standard	7S4SK046040050B22
	8 m	DDP	BSB 35-50 Tuchel 5-pol.	Standard	7S4SK086040050B22
	4 m	DDP	BSB 35-50 Tuchel 5-pol.	High Flex Leder	7S4SH046040050B22
	8 m	DDP	BSB 35-50 Tuchel 5-pol.	High Flex Leder	7S4SH086040050B22
ABITIG® 18F	4 m	DDP	BSB 35-50 Tuchel 5-pol.	Standard	7S4FK046040050B22
	8 m	DDP	BSB 35-50 Tuchel 5-pol.	Standard	7S4FK086040050B22
	4 m	DDP	BSB 35-50 Tuchel 5-pol.	High Flex Leder	7S4FH046040050B22
	8 m	DDP	BSB 35-50 Tuchel 5-pol.	High Flex Leder	7S4FH086040050B22
ABITIG® 20	4 m	DDP	BSB 35-50 Tuchel 5-pol.	Standard	7S5SK046040050B22
	8 m	DDP	BSB 35-50 Tuchel 5-pol.	Standard	7S5SK086040050B22
	4 m	DDP	BSB 35-50 Tuchel 5-pol.	High Flex Leder	7S5SH046040050B22
	8 m	DDP	BSB 35-50 Tuchel 5-pol.	High Flex Leder	7S5SH086040050B22
ABITIG® 20F	4 m	DDP	BSB 35-50 Tuchel 5-pol.	Standard	7S5FK046040050B22
	8 m	DDP	BSB 35-50 Tuchel 5-pol.	Standard	7S5FK086040050B22
	4 m	DDP	BSB 35-50 Tuchel 5-pol.	High Flex Leder	7S5FH046040050B22
	8 m	DDP	BSB 35-50 Tuchel 5-pol.	High Flex Leder	7S5FH086040050B22

Technische Änderungen vorbehalten • Verkaufspreise = unverbindliche Preisempfehlung - Angebot freibleibend • © Copyright

ABITIG®-Brennerpreisliste

passend für WIG-Stromquellen des Fabrikates „rs welding systems“

Brennertyp	Länge	Schalterfunktion	maschinenseitiger Anschluss	Schlauchpaketausführung	Bestellnummer
ABITIG® 12-1	4 m	DDP	BSB 35-50 Tuchel 5-pol.	Standard	7S6SK046040050B22
	8 m	DDP	BSB 35-50 Tuchel 5-pol.	Standard	7S6SK086040050B22
	4 m	DDP	BSB 35-50 Tuchel 5-pol.	High Flex Leder	7S6SH046040050B22
	8 m	DDP	BSB 35-50 Tuchel 5-pol.	High Flex Leder	7S6SH086040050B22
ABITIG® 18SC	4 m	DDP	BSB 35-50 Tuchel 5-pol.	Standard	7S7SK046040050B22
	8 m	DDP	BSB 35-50 Tuchel 5-pol.	Standard	7S7SK086040050B22
	4 m	DDP	BSB 35-50 Tuchel 5-pol.	High Flex Leder	7S7SH046040050B22
	8 m	DDP	BSB 35-50 Tuchel 5-pol.	High Flex Leder	7S7SH086040050B22
ABITIG® 24W	4 m	DDP	BSB 35-50 Tuchel 5-pol.	Standard	7S9SK046040050B22
	8 m	DDP	BSB 35-50 Tuchel 5-pol.	Standard	7S9SK086040050B22
	4 m	DDP	BSB 35-50 Tuchel 5-pol.	High Flex Leder	7S9SH046040050B22
	8 m	DDP	BSB 35-50 Tuchel 5-pol.	High Flex Leder	7S9SH086040050B22
ABITIG® 450W	4 m	DDP	BSB 35-50 Tuchel 5-pol.	Standard	7T5SK046040150B22
	8 m	DDP	BSB 35-50 Tuchel 5-pol.	Standard	7T5SK086040150B22
	4 m	DDP	BSB 35-50 Tuchel 5-pol.	High Flex Leder	7T5SH046040150B22
	8 m	DDP	BSB 35-50 Tuchel 5-pol.	High Flex Leder	7T5SH086040150B22
ABITIG® 260W	4 m	DDP	BSB 35-50 Tuchel 5-pol.	Standard	7T7SK046040150B22
	8 m	DDP	BSB 35-50 Tuchel 5-pol.	Standard	7T7SK086040150B22
	4 m	DDP	BSB 35-50 Tuchel 5-pol.	High Flex Leder	7T7SH046040150B22
	8 m	DDP	BSB 35-50 Tuchel 5-pol.	High Flex Leder	7T7SH086040150B22
ABITIG® 450W SC	4 m	DDP	BSB 35-50 Tuchel 5-pol.	Standard	
	8 m	DDP	BSB 35-50 Tuchel 5-pol.	Standard	
	4 m	DDP	BSB 35-50 Tuchel 5-pol.	High Flex Leder	7T8SH046040150B22
	8 m	DDP	BSB 35-50 Tuchel 5-pol.	High Flex Leder	7T8SH086040150B22

ABITIG®-Brennerpreisliste

passend für WIG-Stromquellen des Fabrikates „selco“



Brennertyp	Länge	Schalterfunktion	maschinenseitiger Anschluss	Schlauchpaketausführung	Bestellnummer
ABITIG® 9	4 m	ED	ZA 9-pol.	Standard	7S1SK043010799A00
	8 m	ED	ZA 9-pol.	Standard	7S1SK083010799A00
	4 m	ED	ZA 9-pol.	High Flex Leder	7S1SH043010799A00
	8 m	ED	ZA 9-pol.	High Flex Leder	7S1SH083010799A00

ABITIG® 9F	4 m	ED	ZA 9-pol.	Standard	7S1FK043010799A00
	8 m	ED	ZA 9-pol.	Standard	7S1FK083010799A00
	4 m	ED	ZA 9-pol.	High Flex Leder	7S1FH043010799A00
	8 m	ED	ZA 9-pol.	High Flex Leder	7S1FH083010799A00

ABITIG® 17	4 m	ED	ZA 9-pol.	Standard	7S2SK043010799A00
	8 m	ED	ZA 9-pol.	Standard	7S2SK083010799A00
	4 m	ED	ZA 9-pol.	High Flex Leder	7S2SH043010799A00
	8 m	ED	ZA 9-pol.	High Flex Leder	7S2SH083010799A00

ABITIG® 17F	4 m	ED	ZA 9-pol.	Standard	7S2FK043010799A00
	8 m	ED	ZA 9-pol.	Standard	7S2FK083010799A00
	4 m	ED	ZA 9-pol.	High Flex Leder	7S2FH043010799A00
	8 m	ED	ZA 9-pol.	High Flex Leder	7S2FH083010799A00

Technische Änderungen vorbehalten • Verkaufspreise = unverbindliche Preisempfehlung - Angebot freibleibend • © Copyright

ABITIG®-Brennerpreisliste

passend für WIG-Stromquellen des Fabrikates „selco“

Brennertyp	Länge	Schalterfunktion	maschinenseitiger Anschluss	Schlauchpaketausführung	Bestellnummer
ABITIG® 26	4 m	ED	ZA 9-pol.	Standard	7S3SK043010799A00
	8 m	ED	ZA 9-pol.	Standard	7S3SK083010799A00
	4 m	ED	ZA 9-pol.	High Flex Leder	7S3SH043010799A00
	8 m	ED	ZA 9-pol.	High Flex Leder	7S3SH083010799A00
ABITIG® 26F	4 m	ED	ZA 9-pol.	Standard	7S3FK043010799A00
	8 m	ED	ZA 9-pol.	Standard	7S3FK083010799A00
	4 m	ED	ZA 9-pol.	High Flex Leder	7S3FH043010799A00
	8 m	ED	ZA 9-pol.	High Flex Leder	7S3FH083010799A00
ABITIG® 24G	4 m	ED	ZA 9-pol.	Standard	7S8SK043010799A00
	8 m	ED	ZA 9-pol.	Standard	7S8SK083010799A00
	4 m	ED	ZA 9-pol.	High Flex Leder	7S8SH043010799A00
	8 m	ED	ZA 9-pol.	High Flex Leder	7S8SH083010799A00
ABITIG® 200	4 m	ED	ZA 9-pol.	Standard	7T4SK043010799A00
	8 m	ED	ZA 9-pol.	Standard	7T4SK083010799A00
	4 m	ED	ZA 9-pol.	High Flex Leder	7T4SH043010799A00
	8 m	ED	ZA 9-pol.	High Flex Leder	7T4SH083010799A00
ABITIG® 200F	4 m	ED	ZA 9-pol.	Standard	7T4FK043010799A00
	8 m	ED	ZA 9-pol.	Standard	7T4FK083010799A00
	4 m	ED	ZA 9-pol.	High Flex Leder	7T4FH043010799A00
	8 m	ED	ZA 9-pol.	High Flex Leder	7T4FH083010799A00
ABITIG® 150	4 m	ED	ZA 9-pol.	Standard	7T6SK043010799A00
	8 m	ED	ZA 9-pol.	Standard	7T6SK083010799A00
	4 m	ED	ZA 9-pol.	High Flex Leder	7T6SH043010799A00
	8 m	ED	ZA 9-pol.	High Flex Leder	7T6SH083010799A00
ABITIG® 150F	4 m	ED	ZA 9-pol.	Standard	7T6FK043010799A00
	8 m	ED	ZA 9-pol.	Standard	7T6FK083010799A00
	4 m	ED	ZA 9-pol.	High Flex Leder	7T6FH043010799A00
	8 m	ED	ZA 9-pol.	High Flex Leder	7T6FH083010799A00

ABITIG®-Brennerpreisliste

passend für WIG-Stromquellen des Fabrikates „selco“

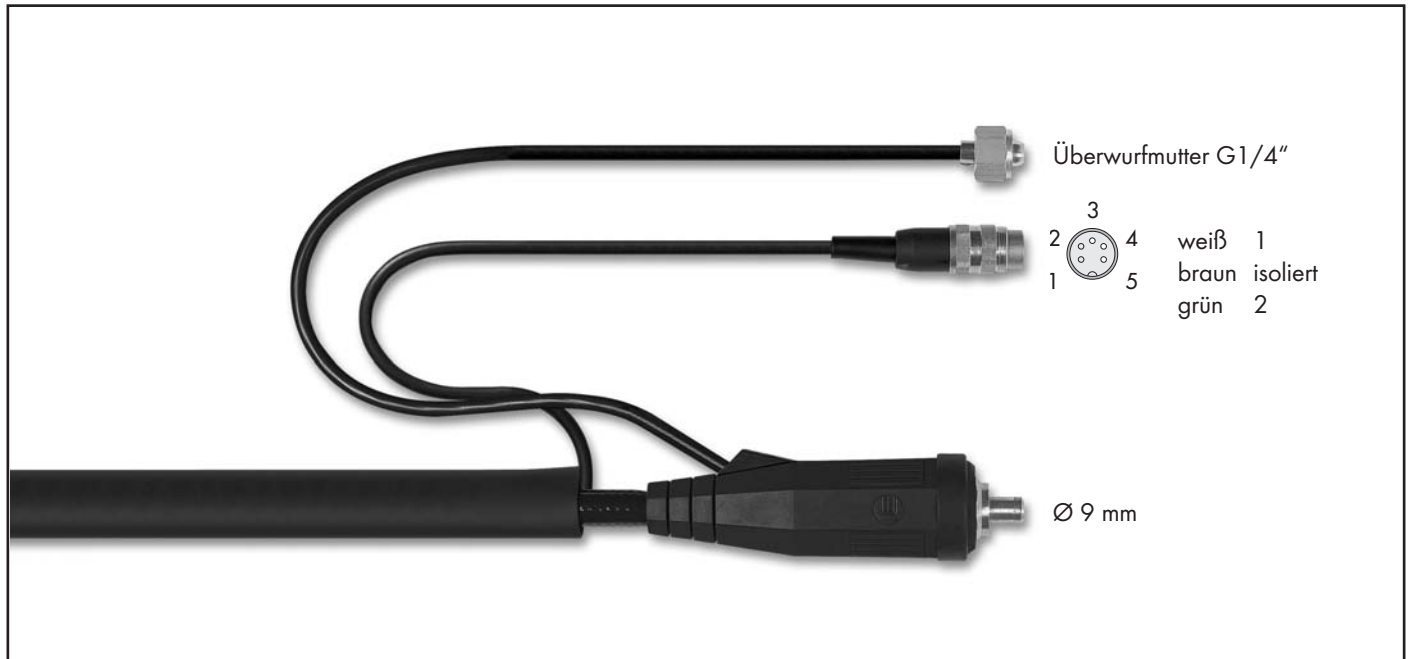

Brennertyp	Länge	Schalterfunktion	maschinenseitiger Anschluss	Schlauchpaketausführung	Bestellnummer
ABITIG® 9	4 m	ED	BSB 10-25 Rundsteckverb. 5-pol.	Standard	7S1SK043012235A01
	8 m	ED	BSB 10-25 Rundsteckverb. 5-pol.	Standard	7S1SK083012235A01
	4 m	ED	BSB 10-25 Rundsteckverb. 5-pol.	High Flex Leder	7S1SH043012235A01
	8 m	ED	BSB 10-25 Rundsteckverb. 5-pol.	High Flex Leder	7S1SH083012235A01

ABITIG® 9F	4 m	ED	BSB 10-25 Rundsteckverb. 5-pol.	Standard	7S1FK043012235A01
	8 m	ED	BSB 10-25 Rundsteckverb. 5-pol.	Standard	7S1FK083012235A01
	4 m	ED	BSB 10-25 Rundsteckverb. 5-pol.	High Flex Leder	7S1FH043012235A01
	8 m	ED	BSB 10-25 Rundsteckverb. 5-pol.	High Flex Leder	7S1FH083012235A01

ABITIG® 17	4 m	ED	BSB 10-25 Rundsteckverb. 5-pol.	Standard	7S2SK043012235A01
	8 m	ED	BSB 10-25 Rundsteckverb. 5-pol.	Standard	7S2SK083012235A01
	4 m	ED	BSB 10-25 Rundsteckverb. 5-pol.	High Flex Leder	7S2SH043012235A01
	8 m	ED	BSB 10-25 Rundsteckverb. 5-pol.	High Flex Leder	7S2SH083012235A01

ABITIG® 17F	4 m	ED	BSB 10-25 Rundsteckverb. 5-pol.	Standard	7S2FK043012235A01
	8 m	ED	BSB 10-25 Rundsteckverb. 5-pol.	Standard	7S2FK083012235A01
	4 m	ED	BSB 10-25 Rundsteckverb. 5-pol.	High Flex Leder	7S2FH043012235A01
	8 m	ED	BSB 10-25 Rundsteckverb. 5-pol.	High Flex Leder	7S2FH083012235A01

Technische Änderungen vorbehalten • Verkaufspreise = unverbindliche Preisempfehlung - Angebot freibleibend • © Copyright

ABITIG®-Brennerpreisliste

passend für WIG-Stromquellen des Fabrikates „selco“

Brennertyp	Länge	Schalterfunktion	maschinenseitiger Anschluss	Schlauchpaketausführung	Bestellnummer
ABITIG® 26	4 m	ED	BSB 10-25 Rundsteckverb. 5-pol.	Standard	7S3SK043012235A01
	8 m	ED	BSB 10-25 Rundsteckverb. 5-pol.	Standard	7S3SK083012235A01
	4 m	ED	BSB 10-25 Rundsteckverb. 5-pol.	High Flex Leder	7S3SH043012235A01
	8 m	ED	BSB 10-25 Rundsteckverb. 5-pol.	High Flex Leder	7S3SH083012235A01
ABITIG® 26F	4 m	ED	BSB 10-25 Rundsteckverb. 5-pol.	Standard	7S3FK043012235A01
	8 m	ED	BSB 10-25 Rundsteckverb. 5-pol.	Standard	7S3FK083012235A01
	4 m	ED	BSB 10-25 Rundsteckverb. 5-pol.	High Flex Leder	7S3FH043012235A01
	8 m	ED	BSB 10-25 Rundsteckverb. 5-pol.	High Flex Leder	7S3FH083012235A01
ABITIG® 24G	4 m	ED	BSB 10-25 Rundsteckverb. 5-pol.	Standard	7S8SK043012235A01
	8 m	ED	BSB 10-25 Rundsteckverb. 5-pol.	Standard	7S8SK083012235A01
	4 m	ED	BSB 10-25 Rundsteckverb. 5-pol.	High Flex Leder	7S8SH043012235A01
	8 m	ED	BSB 10-25 Rundsteckverb. 5-pol.	High Flex Leder	7S8SH083012235A01
ABITIG® 200	4 m	ED	BSB 10-25 Rundsteckverb. 5-pol.	Standard	7T4SK043012235A01
	8 m	ED	BSB 10-25 Rundsteckverb. 5-pol.	Standard	7T4SK083012235A01
	4 m	ED	BSB 10-25 Rundsteckverb. 5-pol.	High Flex Leder	7T4SH043012235A01
	8 m	ED	BSB 10-25 Rundsteckverb. 5-pol.	High Flex Leder	7T4SH083012235A01
ABITIG® 200F	4 m	ED	BSB 10-25 Rundsteckverb. 5-pol.	Standard	7T4FK043012235A01
	8 m	ED	BSB 10-25 Rundsteckverb. 5-pol.	Standard	7T4FK083012235A01
	4 m	ED	BSB 10-25 Rundsteckverb. 5-pol.	High Flex Leder	7T4FH043012235A01
	8 m	ED	BSB 10-25 Rundsteckverb. 5-pol.	High Flex Leder	7T4FH083012235A01
ABITIG® 150	4 m	ED	BSB 10-25 Rundsteckverb. 5-pol.	Standard	7T6SK043012235A01
	8 m	ED	BSB 10-25 Rundsteckverb. 5-pol.	Standard	7T6SK083012235A01
	4 m	ED	BSB 10-25 Rundsteckverb. 5-pol.	High Flex Leder	7T6SH043012235A01
	8 m	ED	BSB 10-25 Rundsteckverb. 5-pol.	High Flex Leder	7T6SH083012235A01
ABITIG® 150F	4 m	ED	BSB 10-25 Rundsteckverb. 5-pol.	Standard	7T6FK043012235A01
	8 m	ED	BSB 10-25 Rundsteckverb. 5-pol.	Standard	7T6FK083012235A01
	4 m	ED	BSB 10-25 Rundsteckverb. 5-pol.	High Flex Leder	7T6FH043012235A01
	8 m	ED	BSB 10-25 Rundsteckverb. 5-pol.	High Flex Leder	7T6FH083012235A01

ABITIG®-Brennerpreisliste

passend für WIG-Stromquellen des Fabrikates „selco“

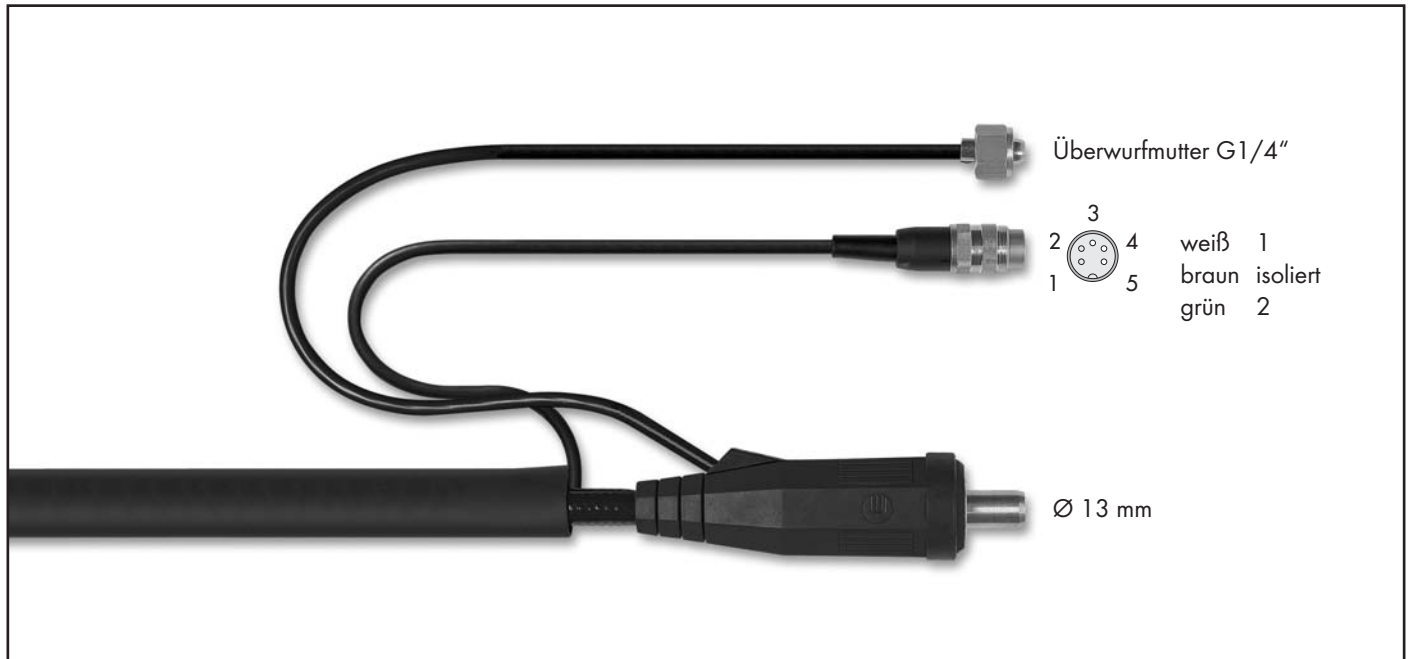

Brennertyp	Länge	Schalterfunktion	maschinenseitiger Anschluss	Schlauchpaketausführung	Bestellnummer
ABITIG® 9	4 m	ED	BSB 35-50 Rundsteckverb. 5-pol.	Standard	7S1SK043010035A01
	8 m	ED	BSB 35-50 Rundsteckverb. 5-pol.	Standard	7S1SK083010035A01
	4 m	ED	BSB 35-50 Rundsteckverb. 5-pol.	High Flex Leder	7S1SH043010035A01
	8 m	ED	BSB 35-50 Rundsteckverb. 5-pol.	High Flex Leder	7S1SH083010035A01

ABITIG® 9F	4 m	ED	BSB 35-50 Rundsteckverb. 5-pol.	Standard	7S1FK043010035A01
	8 m	ED	BSB 35-50 Rundsteckverb. 5-pol.	Standard	7S1FK083010035A01
	4 m	ED	BSB 35-50 Rundsteckverb. 5-pol.	High Flex Leder	7S1FH043010035A01
	8 m	ED	BSB 35-50 Rundsteckverb. 5-pol.	High Flex Leder	7S1FH083010035A01

ABITIG® 17	4 m	ED	BSB 35-50 Rundsteckverb. 5-pol.	Standard	7S2SK043010035A01
	8 m	ED	BSB 35-50 Rundsteckverb. 5-pol.	Standard	7S2SK083010035A01
	4 m	ED	BSB 35-50 Rundsteckverb. 5-pol.	High Flex Leder	7S2SH043010035A01
	8 m	ED	BSB 35-50 Rundsteckverb. 5-pol.	High Flex Leder	7S2SH083010035A01

ABITIG® 17F	4 m	ED	BSB 35-50 Rundsteckverb. 5-pol.	Standard	7S2FK043010035A01
	8 m	ED	BSB 35-50 Rundsteckverb. 5-pol.	Standard	7S2FK083010035A01
	4 m	ED	BSB 35-50 Rundsteckverb. 5-pol.	High Flex Leder	7S2FH043010035A01
	8 m	ED	BSB 35-50 Rundsteckverb. 5-pol.	High Flex Leder	7S2FH083010035A01

Technische Änderungen vorbehalten • Verkaufspreise = unverbindliche Preisempfehlung - Angebot freibleibend • © Copyright

ABITIG®-Brennerpreisliste

passend für WIG-Stromquellen des Fabrikates „selco“

Brennertyp	Länge	Schalterfunktion	maschinenseitiger Anschluss	Schlauchpaketausführung	Bestellnummer
ABITIG® 26	4 m	ED	BSB 35-50 Rundsteckverb. 5-pol.	Standard	7S3SK043010035A01
	8 m	ED	BSB 35-50 Rundsteckverb. 5-pol.	Standard	7S3SK083010035A01
	4 m	ED	BSB 35-50 Rundsteckverb. 5-pol.	High Flex Leder	7S3SH043010035A01
	8 m	ED	BSB 35-50 Rundsteckverb. 5-pol.	High Flex Leder	7S3SH083010035A01
ABITIG® 26F	4 m	ED	BSB 35-50 Rundsteckverb. 5-pol.	Standard	7S3FK043010035A01
	8 m	ED	BSB 35-50 Rundsteckverb. 5-pol.	Standard	7S3FK083010035A01
	4 m	ED	BSB 35-50 Rundsteckverb. 5-pol.	High Flex Leder	7S3FH043010035A01
	8 m	ED	BSB 35-50 Rundsteckverb. 5-pol.	High Flex Leder	7S3FH083010035A01
ABITIG® 24G	4 m	ED	BSB 35-50 Rundsteckverb. 5-pol.	Standard	7S8SK043010035A01
	8 m	ED	BSB 35-50 Rundsteckverb. 5-pol.	Standard	7S8SK083010035A01
	4 m	ED	BSB 35-50 Rundsteckverb. 5-pol.	High Flex Leder	7S8SH043010035A01
	8 m	ED	BSB 35-50 Rundsteckverb. 5-pol.	High Flex Leder	7S8SH083010035A01
ABITIG® 200	4 m	ED	BSB 35-50 Rundsteckverb. 5-pol.	Standard	7T4SK043010035A01
	8 m	ED	BSB 35-50 Rundsteckverb. 5-pol.	Standard	7T4SK083010035A01
	4 m	ED	BSB 35-50 Rundsteckverb. 5-pol.	High Flex Leder	7T4SH043010035A01
	8 m	ED	BSB 35-50 Rundsteckverb. 5-pol.	High Flex Leder	7T4SH083010035A01
ABITIG® 200F	4 m	ED	BSB 35-50 Rundsteckverb. 5-pol.	Standard	7T4FK043010035A01
	8 m	ED	BSB 35-50 Rundsteckverb. 5-pol.	Standard	7T4FK083010035A01
	4 m	ED	BSB 35-50 Rundsteckverb. 5-pol.	High Flex Leder	7T4FH043010035A01
	8 m	ED	BSB 35-50 Rundsteckverb. 5-pol.	High Flex Leder	7T4FH083010035A01
ABITIG® 150	4 m	ED	BSB 35-50 Rundsteckverb. 5-pol.	Standard	7T6SK043010035A01
	8 m	ED	BSB 35-50 Rundsteckverb. 5-pol.	Standard	7T6SK083010035A01
	4 m	ED	BSB 35-50 Rundsteckverb. 5-pol.	High Flex Leder	7T6SH043010035A01
	8 m	ED	BSB 35-50 Rundsteckverb. 5-pol.	High Flex Leder	7T6SH083010035A01
ABITIG® 150F	4 m	ED	BSB 35-50 Rundsteckverb. 5-pol.	Standard	7T6FK043010035A01
	8 m	ED	BSB 35-50 Rundsteckverb. 5-pol.	Standard	7T6FK083010035A01
	4 m	ED	BSB 35-50 Rundsteckverb. 5-pol.	High Flex Leder	7T6FH043010035A01
	8 m	ED	BSB 35-50 Rundsteckverb. 5-pol.	High Flex Leder	7T6FH083010035A01

ABITIG®-Brennerpreisliste

passend für WIG-Stromquellen des Fabrikates „selco“



Brennertyp	Länge	Schalterfunktion	maschinenseitiger Anschluss	Schlauchpaketausführung	Bestellnummer
ABITIG® 9	4 m	ED	BSB 35-50 Tuchel 5-pol.	Standard	7S1SK043010001A01
	8 m	ED	BSB 35-50 Tuchel 5-pol.	Standard	7S1SK083010001A01
	4 m	ED	BSB 35-50 Tuchel 5-pol.	High Flex Leder	7S1SH043010001A01
	8 m	ED	BSB 35-50 Tuchel 5-pol.	High Flex Leder	7S1SH083010001A01

ABITIG® 9F	4 m	ED	BSB 35-50 Tuchel 5-pol.	Standard	7S1FK043010001A01
	8 m	ED	BSB 35-50 Tuchel 5-pol.	Standard	7S1FK083010001A01
	4 m	ED	BSB 35-50 Tuchel 5-pol.	High Flex Leder	7S1FH043010001A01
	8 m	ED	BSB 35-50 Tuchel 5-pol.	High Flex Leder	7S1FH083010001A01

ABITIG® 17	4 m	ED	BSB 35-50 Tuchel 5-pol.	Standard	7S2SK043010001A01
	8 m	ED	BSB 35-50 Tuchel 5-pol.	Standard	7S2SK083010001A01
	4 m	ED	BSB 35-50 Tuchel 5-pol.	High Flex Leder	7S2SH043010001A01
	8 m	ED	BSB 35-50 Tuchel 5-pol.	High Flex Leder	7S2SH083010001A01

ABITIG® 17F	4 m	ED	BSB 35-50 Tuchel 5-pol.	Standard	7S2FK043010001A01
	8 m	ED	BSB 35-50 Tuchel 5-pol.	Standard	7S2FK083010001A01
	4 m	ED	BSB 35-50 Tuchel 5-pol.	High Flex Leder	7S2FH043010001A01
	8 m	ED	BSB 35-50 Tuchel 5-pol.	High Flex Leder	7S2FH083010001A01

Technische Änderungen vorbehalten • Verkaufspreise = unverbindliche Preisempfehlung - Angebot freibleibend • © Copyright

ABITIG®-Brennerpreisliste

passend für WIG-Stromquellen des Fabrikates „selco“

Brennertyp	Länge	Schalterfunktion	maschinenseitiger Anschluss	Schlauchpaketausführung	Bestellnummer
ABITIG® 26	4 m	ED	BSB 35-50 Tuchel 5-pol.	Standard	7S3SK043010001A01
	8 m	ED	BSB 35-50 Tuchel 5-pol.	Standard	7S3SK083010001A01
	4 m	ED	BSB 35-50 Tuchel 5-pol.	High Flex Leder	7S3SH043010001A01
	8 m	ED	BSB 35-50 Tuchel 5-pol.	High Flex Leder	7S3SH083010001A01
ABITIG® 26F	4 m	ED	BSB 35-50 Tuchel 5-pol.	Standard	7S3FK043010001A01
	8 m	ED	BSB 35-50 Tuchel 5-pol.	Standard	7S3FK083010001A01
	4 m	ED	BSB 35-50 Tuchel 5-pol.	High Flex Leder	7S3FH043010001A01
	8 m	ED	BSB 35-50 Tuchel 5-pol.	High Flex Leder	7S3FH083010001A01
ABITIG® 24G	4 m	ED	BSB 35-50 Tuchel 5-pol.	Standard	7S8SK043010001A01
	8 m	ED	BSB 35-50 Tuchel 5-pol.	Standard	7S8SK083010001A01
	4 m	ED	BSB 35-50 Tuchel 5-pol.	High Flex Leder	7S8SH043010001A01
	8 m	ED	BSB 35-50 Tuchel 5-pol.	High Flex Leder	7S8SH083010001A01
ABITIG® 200	4 m	ED	BSB 35-50 Tuchel 5-pol.	Standard	7T4SK043010001A01
	8 m	ED	BSB 35-50 Tuchel 5-pol.	Standard	7T4SK083010001A01
	4 m	ED	BSB 35-50 Tuchel 5-pol.	High Flex Leder	7T4SH043010001A01
	8 m	ED	BSB 35-50 Tuchel 5-pol.	High Flex Leder	7T4SH083010001A01
ABITIG® 200F	4 m	ED	BSB 35-50 Tuchel 5-pol.	Standard	7T4FK043010001A01
	8 m	ED	BSB 35-50 Tuchel 5-pol.	Standard	7T4FK083010001A01
	4 m	ED	BSB 35-50 Tuchel 5-pol.	High Flex Leder	7T4FH043010001A01
	8 m	ED	BSB 35-50 Tuchel 5-pol.	High Flex Leder	7T4FH083010001A01
ABITIG® 150	4 m	ED	BSB 35-50 Tuchel 5-pol.	Standard	7T6SK043010001A01
	8 m	ED	BSB 35-50 Tuchel 5-pol.	Standard	7T6SK083010001A01
	4 m	ED	BSB 35-50 Tuchel 5-pol.	High Flex Leder	7T6SH043010001A01
	8 m	ED	BSB 35-50 Tuchel 5-pol.	High Flex Leder	7T6SH083010001A01
ABITIG® 150F	4 m	ED	BSB 35-50 Tuchel 5-pol.	Standard	7T6FK043010001A01
	8 m	ED	BSB 35-50 Tuchel 5-pol.	Standard	7T6FK083010001A01
	4 m	ED	BSB 35-50 Tuchel 5-pol.	High Flex Leder	7T6FH043010001A01
	8 m	ED	BSB 35-50 Tuchel 5-pol.	High Flex Leder	7T6FH083010001A01

ABITIG®-Brennerpreisliste

passend für WIG-Stromquellen des Fabrikates „selco“



Brennertyp	Länge	Schalterfunktion	maschinenseitiger Anschluss	Schlauchpaketausführung	Bestellnummer
ABITIG® 18	4 m	ED	BSB 35-50 Tuchel 5-pol.	Standard	7S4SK043010001A11
	8 m	ED	BSB 35-50 Tuchel 5-pol.	Standard	7S4SK083010001A11
	4 m	ED	BSB 35-50 Tuchel 5-pol.	High Flex Leder	7S4SH043010001A11
	8 m	ED	BSB 35-50 Tuchel 5-pol.	High Flex Leder	7S4SH083010001A11
ABITIG® 18F	4 m	ED	BSB 35-50 Tuchel 5-pol.	Standard	7S4FK043010001A11
	8 m	ED	BSB 35-50 Tuchel 5-pol.	Standard	7S4FK083010001A11
	4 m	ED	BSB 35-50 Tuchel 5-pol.	High Flex Leder	7S4FH043010001A11
	8 m	ED	BSB 35-50 Tuchel 5-pol.	High Flex Leder	7S4FH083010001A11
ABITIG® 20	4 m	ED	BSB 35-50 Tuchel 5-pol.	Standard	7S5SK043010001A11
	8 m	ED	BSB 35-50 Tuchel 5-pol.	Standard	7S5SK083010001A11
	4 m	ED	BSB 35-50 Tuchel 5-pol.	High Flex Leder	7S5SH043010001A11
	8 m	ED	BSB 35-50 Tuchel 5-pol.	High Flex Leder	7S5SH083010001A11
ABITIG® 20F	4 m	ED	BSB 35-50 Tuchel 5-pol.	Standard	7S5FK043010001A11
	8 m	ED	BSB 35-50 Tuchel 5-pol.	Standard	7S5FK083010001A11
	4 m	ED	BSB 35-50 Tuchel 5-pol.	High Flex Leder	7S5FH043010001A11
	8 m	ED	BSB 35-50 Tuchel 5-pol.	High Flex Leder	7S5FH083010001A11

Technische Änderungen vorbehalten • Verkaufspreise = unverbindliche Preisempfehlung - Angebot freibleibend • © Copyright

ABITIG®-Brennerpreisliste

passend für WIG-Stromquellen des Fabrikates „selco“

Brennertyp	Länge	Schalterfunktion	maschinenseitiger Anschluss	Schlauchpaketausführung	Bestellnummer
ABITIG® 12-1	4 m	ED	BSB 35-50 Tuchel 5-pol.	Standard	7S6SK043010001A11
	8 m	ED	BSB 35-50 Tuchel 5-pol.	Standard	7S6SK083010001A11
	4 m	ED	BSB 35-50 Tuchel 5-pol.	High Flex Leder	7S6SH043010001A11
	8 m	ED	BSB 35-50 Tuchel 5-pol.	High Flex Leder	7S6SH083010001A11
ABITIG® 18SC	4 m	ED	BSB 35-50 Tuchel 5-pol.	Standard	7S7SK043010001A11
	8 m	ED	BSB 35-50 Tuchel 5-pol.	Standard	7S7SK083010001A11
	4 m	ED	BSB 35-50 Tuchel 5-pol.	High Flex Leder	7S7SH043010001A11
	8 m	ED	BSB 35-50 Tuchel 5-pol.	High Flex Leder	7S7SH083010001A11
ABITIG® 24W	4 m	ED	BSB 35-50 Tuchel 5-pol.	Standard	7S9SK043010001A11
	8 m	ED	BSB 35-50 Tuchel 5-pol.	Standard	7S9SK083010001A11
	4 m	ED	BSB 35-50 Tuchel 5-pol.	High Flex Leder	7S9SH043010001A11
	8 m	ED	BSB 35-50 Tuchel 5-pol.	High Flex Leder	7S9SH083010001A11
ABITIG® 450W	4 m	ED	BSB 35-50 Tuchel 5-pol.	Standard	7T5SK043010101A11
	8 m	ED	BSB 35-50 Tuchel 5-pol.	Standard	7T5SK083010101A11
	4 m	ED	BSB 35-50 Tuchel 5-pol.	High Flex Leder	7T5SH043010101A11
	8 m	ED	BSB 35-50 Tuchel 5-pol.	High Flex Leder	7T5SH083010101A11
ABITIG® 260W	4 m	ED	BSB 35-50 Tuchel 5-pol.	Standard	7T7SK043010101A11
	8 m	ED	BSB 35-50 Tuchel 5-pol.	Standard	7T7SK083010101A11
	4 m	ED	BSB 35-50 Tuchel 5-pol.	High Flex Leder	7T7SH043010101A11
	8 m	ED	BSB 35-50 Tuchel 5-pol.	High Flex Leder	7T7SH083010101A11
ABITIG® 450W SC	4 m	ED	BSB 35-50 Tuchel 5-pol.	Standard	
	8 m	ED	BSB 35-50 Tuchel 5-pol.	Standard	
	4 m	ED	BSB 35-50 Tuchel 5-pol.	High Flex Leder	7T8SH043010101A11
	8 m	ED	BSB 35-50 Tuchel 5-pol.	High Flex Leder	7T8SH083010101A11

ABITIG®-Brennerpreisliste

passend für WIG-Stromquellen des Fabrikates „stel“



Brennertyp	Länge	Schalterfunktion	maschinenseitiger Anschluss	Schlauchpaketausführung	Bestellnummer
ABITIG® 9	4 m	DD	ZA 9-pol.	Standard	7S1SK043020797B00
	8 m	DD	ZA 9-pol.	Standard	7S1SK083020797B00
	4 m	DD	ZA 9-pol.	High Flex Leder	7S1SH043020797B00
	8 m	DD	ZA 9-pol.	High Flex Leder	7S1SH083020797B00
ABITIG® 9F	4 m	DD	ZA 9-pol.	Standard	7S1FK043020797B00
	8 m	DD	ZA 9-pol.	Standard	7S1FK083020797B00
	4 m	DD	ZA 9-pol.	High Flex Leder	7S1FH043020797B00
	8 m	DD	ZA 9-pol.	High Flex Leder	7S1FH083020797B00
ABITIG® 17	4 m	DD	ZA 9-pol.	Standard	7S2SK043020797B00
	8 m	DD	ZA 9-pol.	Standard	7S2SK083020797B00
	4 m	DD	ZA 9-pol.	High Flex Leder	7S2SH043020797B00
	8 m	DD	ZA 9-pol.	High Flex Leder	7S2SH083020797B00
ABITIG® 17F	4 m	DD	ZA 9-pol.	Standard	7S2FK043020797B00
	8 m	DD	ZA 9-pol.	Standard	7S2FK083020797B00
	4 m	DD	ZA 9-pol.	High Flex Leder	7S2FH043020797B00
	8 m	DD	ZA 9-pol.	High Flex Leder	7S2FH083020797B00

Technische Änderungen vorbehalten • Verkaufspreise = unverbindliche Preisempfehlung - Angebot freibleibend • © Copyright

ABITIG®-Brennerpreisliste

passend für WIG-Stromquellen des Fabrikates „stel“

Brennertyp	Länge	Schalterfunktion	maschinenseitiger Anschluss	Schlauchpaketausführung	Bestellnummer
ABITIG® 26	4 m	DD	ZA 9-pol.	Standard	7S3SK043020797B00
	8 m	DD	ZA 9-pol.	Standard	7S3SK083020797B00
	4 m	DD	ZA 9-pol.	High Flex Leder	7S3SH043020797B00
	8 m	DD	ZA 9-pol.	High Flex Leder	7S3SH083020797B00

ABITIG® 26F	4 m	DD	ZA 9-pol.	Standard	7S3FK043020797B00
	8 m	DD	ZA 9-pol.	Standard	7S3FK083020797B00
	4 m	DD	ZA 9-pol.	High Flex Leder	7S3FH043020797B00
	8 m	DD	ZA 9-pol.	High Flex Leder	7S3FH083020797B00

ABITIG® 24G	4 m	DD	ZA 9-pol.	Standard	7S8SK043020797B00
	8 m	DD	ZA 9-pol.	Standard	7S8SK083020797B00
	4 m	DD	ZA 9-pol.	High Flex Leder	7S8SH043020797B00
	8 m	DD	ZA 9-pol.	High Flex Leder	7S8SH083020797B00

ABITIG® 200	4 m	DD	ZA 9-pol.	Standard	7T4SK043020797B00
	8 m	DD	ZA 9-pol.	Standard	7T4SK083020797B00
	4 m	DD	ZA 9-pol.	High Flex Leder	7T4SH043020797B00
	8 m	DD	ZA 9-pol.	High Flex Leder	7T4SH083020797B00

ABITIG® 200F	4 m	DD	ZA 9-pol.	Standard	7T4FK043020797B00
	8 m	DD	ZA 9-pol.	Standard	7T4FK083020797B00
	4 m	DD	ZA 9-pol.	High Flex Leder	7T4FH043020797B00
	8 m	DD	ZA 9-pol.	High Flex Leder	7T4FH083020797B00

ABITIG® 150	4 m	DD	ZA 9-pol.	Standard	7T6SK043020797B00
	8 m	DD	ZA 9-pol.	Standard	7T6SK083020797B00
	4 m	DD	ZA 9-pol.	High Flex Leder	7T6SH043020797B00
	8 m	DD	ZA 9-pol.	High Flex Leder	7T6SH083020797B00

ABITIG® 150F	4 m	DD	ZA 9-pol.	Standard	7T6FK043020797B00
	8 m	DD	ZA 9-pol.	Standard	7T6FK083020797B00
	4 m	DD	ZA 9-pol.	High Flex Leder	7T6FH043020797B00
	8 m	DD	ZA 9-pol.	High Flex Leder	7T6FH083020797B00

ABITIG®-Brennerpreisliste

passend für WIG-Stromquellen des Fabrikates „stel“ (Kombi-Anlage)



Brennertyp	Länge	Schalterfunktion	maschinenseitiger Anschluss	Schlauchpaketausführung	Bestellnummer
ABITIG® 9	4 m	ED	MAG - ZA	Standard	7S1SK043013496A00
	8 m	ED	MAG - ZA	Standard	7S1SK083013496A00
	4 m	ED	MAG - ZA	High Flex Leder	7S1SH043013496A00
	8 m	ED	MAG - ZA	High Flex Leder	7S1SH083013496A00
ABITIG® 9F	4 m	ED	MAG - ZA	Standard	7S1FK043013496A00
	8 m	ED	MAG - ZA	Standard	7S1FK083013496A00
	4 m	ED	MAG - ZA	High Flex Leder	7S1FH043013496A00
	8 m	ED	MAG - ZA	High Flex Leder	7S1FH083013496A00
ABITIG® 17	4 m	ED	MAG - ZA	Standard	7S2SK043013496A00
	8 m	ED	MAG - ZA	Standard	7S2SK083013496A00
	4 m	ED	MAG - ZA	High Flex Leder	7S2SH043013496A00
	8 m	ED	MAG - ZA	High Flex Leder	7S2SH083013496A00
ABITIG® 17F	4 m	ED	MAG - ZA	Standard	7S2FK043013496A00
	8 m	ED	MAG - ZA	Standard	7S2FK083013496A00
	4 m	ED	MAG - ZA	High Flex Leder	7S2FH043013496A00
	8 m	ED	MAG - ZA	High Flex Leder	7S2FH083013496A00

Technische Änderungen vorbehalten • Verkaufspreise = unverbindliche Preisempfehlung - Angebot freibleibend • © Copyright

ABITIG®-Brennerpreisliste

passend für WIG-Stromquellen des Fabrikates „stel“ (Kombi-Anlage)

Brennertyp	Länge	Schalterfunktion	maschinenseitiger Anschluss	Schlauchpaketausführung	Bestellnummer
ABITIG® 26	4 m	ED	MAG - ZA	Standard	7S3SK043013496A00
	8 m	ED	MAG - ZA	Standard	7S3SK083013496A00
	4 m	ED	MAG - ZA	High Flex Leder	7S3SH043013496A00
	8 m	ED	MAG - ZA	High Flex Leder	7S3SH083013496A00
ABITIG® 26F	4 m	ED	MAG - ZA	Standard	7S3FK043013496A00
	8 m	ED	MAG - ZA	Standard	7S3FK083013496A00
	4 m	ED	MAG - ZA	High Flex Leder	7S3FH043013496A00
	8 m	ED	MAG - ZA	High Flex Leder	7S3FH083013496A00
ABITIG® 24G	4 m	ED	MAG - ZA	Standard	7S8SK043013496A00
	8 m	ED	MAG - ZA	Standard	7S8SK083013496A00
	4 m	ED	MAG - ZA	High Flex Leder	7S8SH043013496A00
	8 m	ED	MAG - ZA	High Flex Leder	7S8SH083013496A00
ABITIG® 200	4 m	ED	MAG - ZA	Standard	7T4SK043013496A00
	8 m	ED	MAG - ZA	Standard	7T4SK083013496A00
	4 m	ED	MAG - ZA	High Flex Leder	7T4SH043013496A00
	8 m	ED	MAG - ZA	High Flex Leder	7T4SH083013496A00
ABITIG® 200F	4 m	ED	MAG - ZA	Standard	7T4FK043013496A00
	8 m	ED	MAG - ZA	Standard	7T4FK083013496A00
	4 m	ED	MAG - ZA	High Flex Leder	7T4FH043013496A00
	8 m	ED	MAG - ZA	High Flex Leder	7T4FH083013496A00
ABITIG® 150	4 m	ED	MAG - ZA	Standard	7T6SK043013496A00
	8 m	ED	MAG - ZA	Standard	7T6SK083013496A00
	4 m	ED	MAG - ZA	High Flex Leder	7T6SH043013496A00
	8 m	ED	MAG - ZA	High Flex Leder	7T6SH083013496A00
ABITIG® 150F	4 m	ED	MAG - ZA	Standard	7T6FK043013496A00
	8 m	ED	MAG - ZA	Standard	7T6FK083013496A00
	4 m	ED	MAG - ZA	High Flex Leder	7T6FH043013496A00
	8 m	ED	MAG - ZA	High Flex Leder	7T6FH083013496A00

ABITIG®-Brennerpreisliste

passend für WIG-Stromquellen des Fabrikates „stel“ Up/Down

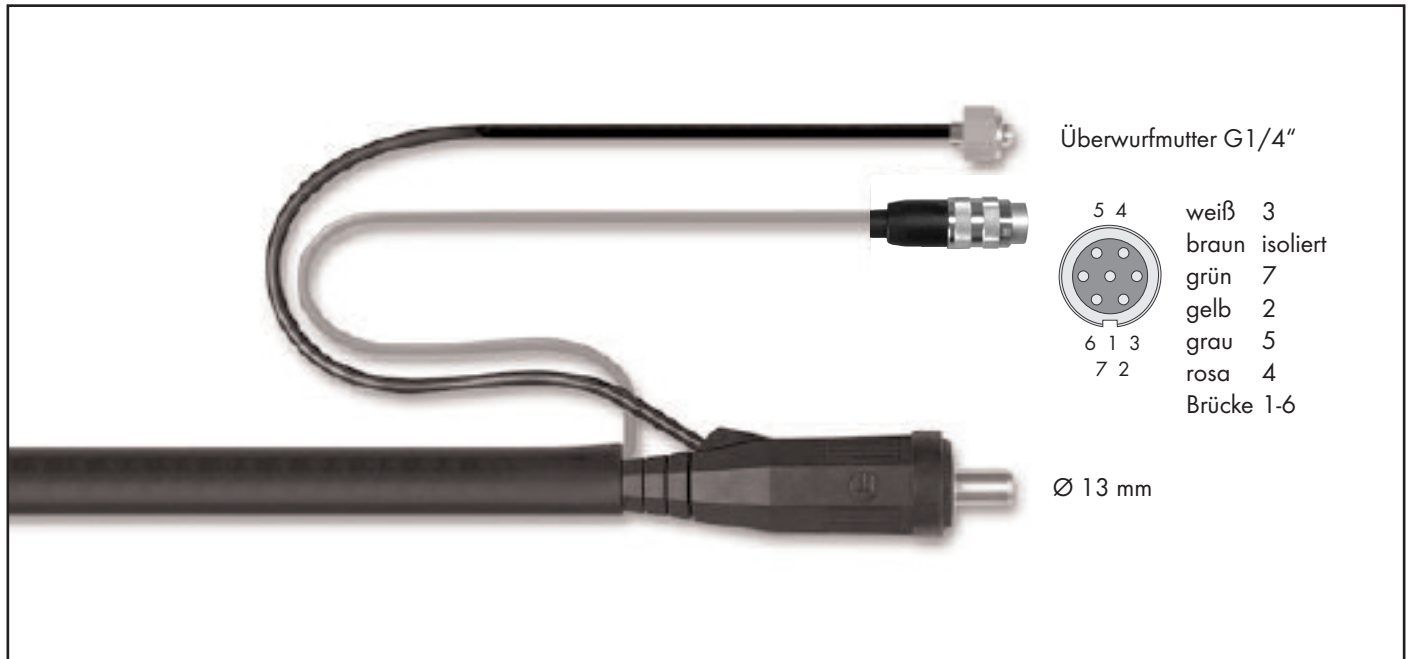

Brennertyp	Länge	Schalterfunktion	maschinenseitiger Anschluss	Schlauchpaketausführung	Bestellnummer
ABITIG® 9	4 m	UD	BSB 35-50 Kabelstecker 7-pol.	Standard	7S1SK046350048A01
	8 m	UD	BSB 35-50 Kabelstecker 7-pol.	Standard	7S1SK086350048A01
	4 m	UD	BSB 35-50 Kabelstecker 7-pol.	High Flex Leder	7S1SH046350048A01
	8 m	UD	BSB 35-50 Kabelstecker 7-pol.	High Flex Leder	7S1SH086350048A01
ABITIG® 9F	4 m	UD	BSB 35-50 Kabelstecker 7-pol.	Standard	7S1FK046350048A01
	8 m	UD	BSB 35-50 Kabelstecker 7-pol.	Standard	7S1FK086350048A01
	4 m	UD	BSB 35-50 Kabelstecker 7-pol.	High Flex Leder	7S1FH046350048A01
	8 m	UD	BSB 35-50 Kabelstecker 7-pol.	High Flex Leder	7S1FH086350048A01
ABITIG® 17	4 m	UD	BSB 35-50 Kabelstecker 7-pol.	Standard	7S2SK046350048A01
	8 m	UD	BSB 35-50 Kabelstecker 7-pol.	Standard	7S2SK086350048A01
	4 m	UD	BSB 35-50 Kabelstecker 7-pol.	High Flex Leder	7S2SH046350048A01
	8 m	UD	BSB 35-50 Kabelstecker 7-pol.	High Flex Leder	7S2SH086350048A01
ABITIG® 17F	4 m	UD	BSB 35-50 Kabelstecker 7-pol.	Standard	7S2FK046350048A01
	8 m	UD	BSB 35-50 Kabelstecker 7-pol.	Standard	7S2FK086350048A01
	4 m	UD	BSB 35-50 Kabelstecker 7-pol.	High Flex Leder	7S2FH046350048A01
	8 m	UD	BSB 35-50 Kabelstecker 7-pol.	High Flex Leder	7S2FH086350048A01

Technische Änderungen vorbehalten • Verkaufspreise = unverbindliche Preisempfehlung - Angebot freibleibend • © Copyright

ABITIG®-Brennerpreisliste

passend für WIG-Stromquellen des Fabrikates „stel“ Up/Down

Brennertyp	Länge	Schalterfunktion	maschinenseitiger Anschluss	Schlauchpaketausführung	Bestellnummer
ABITIG® 26	4 m	UD	BSB 35-50 Kabelstecker 7-pol.	Standard	7S3SK046350048A01
	8 m	UD	BSB 35-50 Kabelstecker 7-pol.	Standard	7S3SK086350048A01
	4 m	UD	BSB 35-50 Kabelstecker 7-pol.	High Flex Leder	7S3SH046350048A01
	8 m	UD	BSB 35-50 Kabelstecker 7-pol.	High Flex Leder	7S3SH086350048A01
ABITIG® 26F	4 m	UD	BSB 35-50 Kabelstecker 7-pol.	Standard	7S3FK046350048A01
	8 m	UD	BSB 35-50 Kabelstecker 7-pol.	Standard	7S3FK086350048A01
	4 m	UD	BSB 35-50 Kabelstecker 7-pol.	High Flex Leder	7S3FH046350048A01
	8 m	UD	BSB 35-50 Kabelstecker 7-pol.	High Flex Leder	7S3FH086350048A01
ABITIG® 24G	4 m	UD	BSB 35-50 Kabelstecker 7-pol.	Standard	7S8SK046350048A01
	8 m	UD	BSB 35-50 Kabelstecker 7-pol.	Standard	7S8SK086350048A01
	4 m	UD	BSB 35-50 Kabelstecker 7-pol.	High Flex Leder	7S8SH046350048A01
	8 m	UD	BSB 35-50 Kabelstecker 7-pol.	High Flex Leder	7S8SH086350048A01
ABITIG® 200	4 m	UD	BSB 35-50 Kabelstecker 7-pol.	Standard	7T4SK046350048A01
	8 m	UD	BSB 35-50 Kabelstecker 7-pol.	Standard	7T4SK086350048A01
	4 m	UD	BSB 35-50 Kabelstecker 7-pol.	High Flex Leder	7T4SH046350048A01
	8 m	UD	BSB 35-50 Kabelstecker 7-pol.	High Flex Leder	7T4SH086350048A01
ABITIG® 200F	4 m	UD	BSB 35-50 Kabelstecker 7-pol.	Standard	7T4FK046350048A01
	8 m	UD	BSB 35-50 Kabelstecker 7-pol.	Standard	7T4FK086350048A01
	4 m	UD	BSB 35-50 Kabelstecker 7-pol.	High Flex Leder	7T4FH046350048A01
	8 m	UD	BSB 35-50 Kabelstecker 7-pol.	High Flex Leder	7T4FH086350048A01
ABITIG® 150	4 m	UD	BSB 35-50 Kabelstecker 7-pol.	Standard	7T6SK046350048A01
	8 m	UD	BSB 35-50 Kabelstecker 7-pol.	Standard	7T6SK086350048A01
	4 m	UD	BSB 35-50 Kabelstecker 7-pol.	High Flex Leder	7T6SH046350048A01
	8 m	UD	BSB 35-50 Kabelstecker 7-pol.	High Flex Leder	7T6SH086350048A01
ABITIG® 150F	4 m	UD	BSB 35-50 Kabelstecker 7-pol.	Standard	7T6FK046350048A01
	8 m	UD	BSB 35-50 Kabelstecker 7-pol.	Standard	7T6FK086350048A01
	4 m	UD	BSB 35-50 Kabelstecker 7-pol.	High Flex Leder	7T6FH046350048A01
	8 m	UD	BSB 35-50 Kabelstecker 7-pol.	High Flex Leder	7T6FH086350048A01

ABITIG®-Brennerpreisliste

passend für WIG-Stromquellen des Fabrikates „stel“



Brennertyp	Länge	Schalterfunktion	maschinenseitiger Anschluss	Schlauchpaketausführung	Bestellnummer
ABITIG® 18	4 m	DD	ZA 9-pol.	Standard	7S4SK043020797B12
	8 m	DD	ZA 9-pol.	Standard	7S4SK083020797B12
	4 m	DD	ZA 9-pol.	High Flex Leder	7S4SH043020797B12
	8 m	DD	ZA 9-pol.	High Flex Leder	7S4SH083020797B12
ABITIG® 18F	4 m	DD	ZA 9-pol.	Standard	7S4FK043020797B12
	8 m	DD	ZA 9-pol.	Standard	7S4FK083020797B12
	4 m	DD	ZA 9-pol.	High Flex Leder	7S4FH043020797B12
	8 m	DD	ZA 9-pol.	High Flex Leder	7S4FH083020797B12
ABITIG® 20	4 m	DD	ZA 9-pol.	Standard	7S5SK043020797B12
	8 m	DD	ZA 9-pol.	Standard	7S5SK083020797B12
	4 m	DD	ZA 9-pol.	High Flex Leder	7S5SH043020797B12
	8 m	DD	ZA 9-pol.	High Flex Leder	7S5SH083020797B12
ABITIG® 20F	4 m	DD	ZA 9-pol.	Standard	7S5FK043020797B12
	8 m	DD	ZA 9-pol.	Standard	7S5FK083020797B12
	4 m	DD	ZA 9-pol.	High Flex Leder	7S5FH043020797B12
	8 m	DD	ZA 9-pol.	High Flex Leder	7S5FH083020797B12

Technische Änderungen vorbehalten • Verkaufspreise = unverbindliche Preisempfehlung - Angebot freibleibend • © Copyright

ABITIG®-Brennerpreisliste

passend für WIG-Stromquellen des Fabrikates „stel“

Brennertyp	Länge	Schalterfunktion	maschinenseitiger Anschluss	Schlauchpaketausführung	Bestellnummer
ABITIG® 12-1	4 m	DD	ZA 9-pol.	Standard	7S6SK043020797B12
	8 m	DD	ZA 9-pol.	Standard	7S6SK083020797B12
	4 m	DD	ZA 9-pol.	High Flex Leder	7S6SH043020797B12
	8 m	DD	ZA 9-pol.	High Flex Leder	7S6SH083020797B12
ABITIG® 18SC	4 m	DD	ZA 9-pol.	Standard	7S7SK043020797B12
	8 m	DD	ZA 9-pol.	Standard	7S7SK083020797B12
	4 m	DD	ZA 9-pol.	High Flex Leder	7S7SH043020797B12
	8 m	DD	ZA 9-pol.	High Flex Leder	7S7SH083020797B12
ABITIG® 24W	4 m	DD	ZA 9-pol.	Standard	7S9SK043020797B12
	8 m	DD	ZA 9-pol.	Standard	7S9SK083020797B12
	4 m	DD	ZA 9-pol.	High Flex Leder	7S9SH043020797B12
	8 m	DD	ZA 9-pol.	High Flex Leder	7S9SH083020797B12
ABITIG® 450W	4 m	DD	ZA 9-pol.	Standard	7T5SK043020797B12
	8 m	DD	ZA 9-pol.	Standard	7T5SK083020797B12
	4 m	DD	ZA 9-pol.	High Flex Leder	7T5SH043020797B12
	8 m	DD	ZA 9-pol.	High Flex Leder	7T5SH083020797B12
ABITIG® 260W	4 m	DD	ZA 9-pol.	Standard	7T7SK043020797B12
	8 m	DD	ZA 9-pol.	Standard	7T7SK083020797B12
	4 m	DD	ZA 9-pol.	High Flex Leder	7T7SH043020797B12
	8 m	DD	ZA 9-pol.	High Flex Leder	7T7SH083020797B12
ABITIG® 450W SC	4 m	DD	ZA 9-pol.	Standard	
	8 m	DD	ZA 9-pol.	Standard	
	4 m	DD	ZA 9-pol.	High Flex Leder	7T8SH043020797B12
	8 m	DD	ZA 9-pol.	High Flex Leder	7T8SH083020797B12

ABITIG®-Brennerpreisliste

passend für WIG-Stromquellen des Fabrikates „stel“ Up/Down

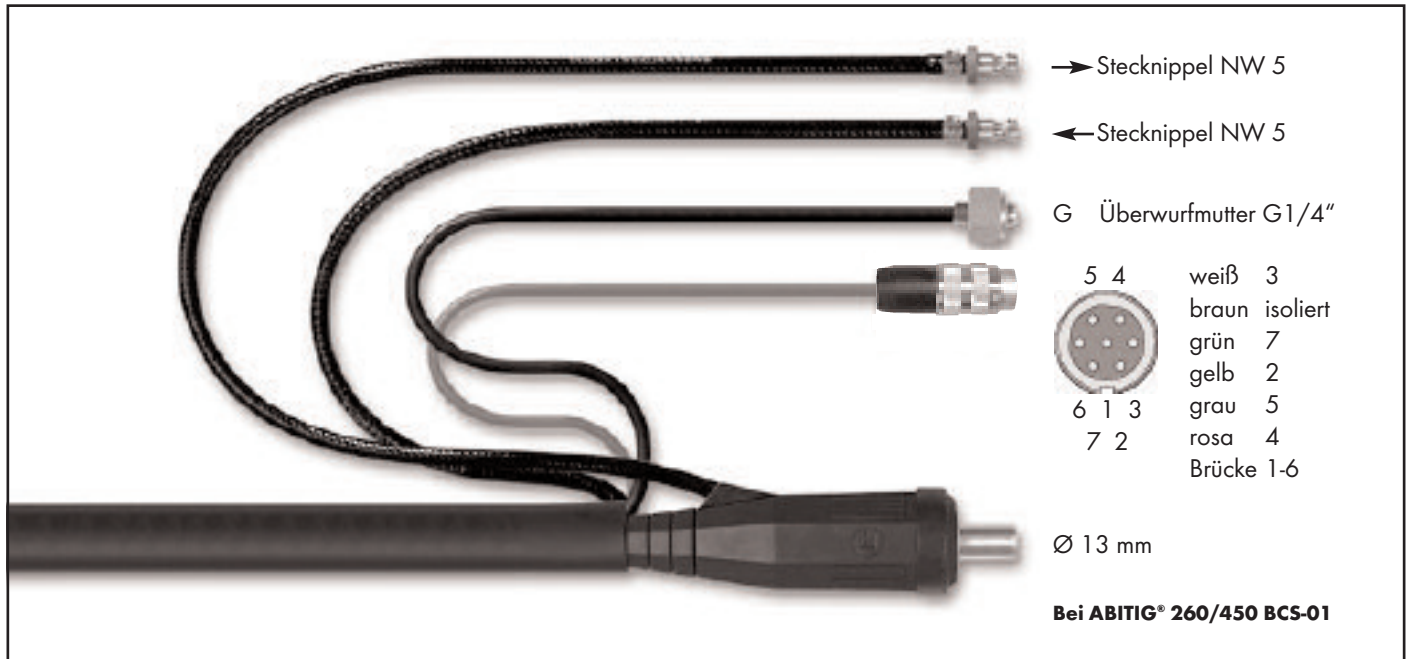

Brennertyp	Länge	Schalterfunktion	maschinenseitiger Anschluss	Schlauchpaketausführung	Bestellnummer
ABITIG® 18	4 m	UD	BSB 35-50 Kabelstecker 7-pol.	Standard	7S4SK046350048A11
	8 m	UD	BSB 35-50 Kabelstecker 7-pol.	Standard	7S4SK086350048A11
	4 m	UD	BSB 35-50 Kabelstecker 7-pol.	High Flex Leder	7S4SH046350048A11
	8 m	UD	BSB 35-50 Kabelstecker 7-pol.	High Flex Leder	7S4SH086350048A11

ABITIG® 18F	4 m	UD	BSB 35-50 Kabelstecker 7-pol.	Standard	7S4FK046350048A11
	8 m	UD	BSB 35-50 Kabelstecker 7-pol.	Standard	7S4FK086350048A11
	4 m	UD	BSB 35-50 Kabelstecker 7-pol.	High Flex Leder	7S4FH046350048A11
	8 m	UD	BSB 35-50 Kabelstecker 7-pol.	High Flex Leder	7S4FH086350048A11

ABITIG® 20	4 m	UD	BSB 35-50 Kabelstecker 7-pol.	Standard	7S5SK046350048A11
	8 m	UD	BSB 35-50 Kabelstecker 7-pol.	Standard	7S5SK086350048A11
	4 m	UD	BSB 35-50 Kabelstecker 7-pol.	High Flex Leder	7S5SH046350048A11
	8 m	UD	BSB 35-50 Kabelstecker 7-pol.	High Flex Leder	7S5SH086350048A11

ABITIG® 20F	4 m	UD	BSB 35-50 Kabelstecker 7-pol.	Standard	7S5FK046350048A11
	8 m	UD	BSB 35-50 Kabelstecker 7-pol.	Standard	7S5FK086350048A11
	4 m	UD	BSB 35-50 Kabelstecker 7-pol.	High Flex Leder	7S5FH046350048A11
	8 m	UD	BSB 35-50 Kabelstecker 7-pol.	High Flex Leder	7S5FH086350048A11

Technische Änderungen vorbehalten • Verkaufspreise = unverbindliche Preisempfehlung - Angebot freibleibend • © Copyright

ABITIG®-Brennerpreisliste

passend für WIG-Stromquellen des Fabrikates „stel“ Up/Down

Brennertyp	Länge	Schalterfunktion	maschinenseitiger Anschluss	Schlauchpaketausführung	Bestellnummer
ABITIG® 12-1	4 m	UD	BSB 35-50 Kabelstecker 7-pol.	Standard	7S6SK046350048A11
	8 m	UD	BSB 35-50 Kabelstecker 7-pol.	Standard	7S6SK086350048A11
	4 m	UD	BSB 35-50 Kabelstecker 7-pol.	High Flex Leder	7S6SH046350048A11
	8 m	UD	BSB 35-50 Kabelstecker 7-pol.	High Flex Leder	7S6SH086350048A11
ABITIG® 18SC	4 m	UD	BSB 35-50 Kabelstecker 7-pol.	Standard	7S7SK046350048A11
	8 m	UD	BSB 35-50 Kabelstecker 7-pol.	Standard	7S7SK086350048A11
	4 m	UD	BSB 35-50 Kabelstecker 7-pol.	High Flex Leder	7S7SH046350048A11
	8 m	UD	BSB 35-50 Kabelstecker 7-pol.	High Flex Leder	7S7SH086350048A11
ABITIG® 24W	4 m	UD	BSB 35-50 Kabelstecker 7-pol.	Standard	7S9SK046350048A11
	8 m	UD	BSB 35-50 Kabelstecker 7-pol.	Standard	7S9SK086350048A11
	4 m	UD	BSB 35-50 Kabelstecker 7-pol.	High Flex Leder	7S9SH046350048A11
	8 m	UD	BSB 35-50 Kabelstecker 7-pol.	High Flex Leder	7S9SH086350048A11
ABITIG® 450W	4 m	UD	BSB 35-50 Kabelstecker 7-pol.	Standard	7T5SK046350148A11
	8 m	UD	BSB 35-50 Kabelstecker 7-pol.	Standard	7T5SK086350148A11
	4 m	UD	BSB 35-50 Kabelstecker 7-pol.	High Flex Leder	7T5SH046350148A11
	8 m	UD	BSB 35-50 Kabelstecker 7-pol.	High Flex Leder	7T5SH086350148A11
ABITIG® 260W	4 m	UD	BSB 35-50 Kabelstecker 7-pol.	Standard	7T7SK046350148A11
	8 m	UD	BSB 35-50 Kabelstecker 7-pol.	Standard	7T7SK086350148A11
	4 m	UD	BSB 35-50 Kabelstecker 7-pol.	High Flex Leder	7T7SH046350148A11
	8 m	UD	BSB 35-50 Kabelstecker 7-pol.	High Flex Leder	7T7SH086350148A11
ABITIG® 450W SC	4 m	UD	BSB 35-50 Kabelstecker 7-pol.	Standard	
	8 m	UD	BSB 35-50 Kabelstecker 7-pol.	Standard	
	4 m	UD	BSB 35-50 Kabelstecker 7-pol.	High Flex Leder	7T8SH046350148A11
	8 m	UD	BSB 35-50 Kabelstecker 7-pol.	High Flex Leder	7T8SH086350148A11

ABITIG®-Brennerpreisliste

passend für WIG-Stromquellen des Fabrikates „utp“



Brennertyp	Länge	Schalterfunktion	maschinenseitiger Anschluss	Schlauchpaketausführung	Bestellnummer
ABITIG® 9	4 m	DD	BSB 35-50 Amphenol 4-pol.	Standard	7S1SK043020010B01
	8 m	DD	BSB 35-50 Amphenol 4-pol.	Standard	7S1SK083020010B01
	4 m	DD	BSB 35-50 Amphenol 4-pol.	High Flex Leder	7S1SH043020010B01
	8 m	DD	BSB 35-50 Amphenol 4-pol.	High Flex Leder	7S1SH083020010B01
ABITIG® 9F	4 m	DD	BSB 35-50 Amphenol 4-pol.	Standard	7S1FK043020010B01
	8 m	DD	BSB 35-50 Amphenol 4-pol.	Standard	7S1FK083020010B01
	4 m	DD	BSB 35-50 Amphenol 4-pol.	High Flex Leder	7S1FH043020010B01
	8 m	DD	BSB 35-50 Amphenol 4-pol.	High Flex Leder	7S1FH083020010B01
ABITIG® 17	4 m	DD	BSB 35-50 Amphenol 4-pol.	Standard	7S2SK043020010B01
	8 m	DD	BSB 35-50 Amphenol 4-pol.	Standard	7S2SK083020010B01
	4 m	DD	BSB 35-50 Amphenol 4-pol.	High Flex Leder	7S2SH043020010B01
	8 m	DD	BSB 35-50 Amphenol 4-pol.	High Flex Leder	7S2SH083020010B01
ABITIG® 17F	4 m	DD	BSB 35-50 Amphenol 4-pol.	Standard	7S2FK043020010B01
	8 m	DD	BSB 35-50 Amphenol 4-pol.	Standard	7S2FK083020010B01
	4 m	DD	BSB 35-50 Amphenol 4-pol.	High Flex Leder	7S2FH043020010B01
	8 m	DD	BSB 35-50 Amphenol 4-pol.	High Flex Leder	7S2FH083020010B01

Technische Änderungen vorbehalten • Verkaufspreise = unverbindliche Preisempfehlung - Angebot freibleibend • © Copyright

ABITIG®-Brennerpreisliste

passend für WIG-Stromquellen des Fabrikates „utp“

Brennertyp	Länge	Schalterfunktion	maschinenseitiger Anschluss	Schlauchpaketausführung	Bestellnummer
ABITIG® 26	4 m	DD	BSB 35-50 Amphenol 4-pol.	Standard	7S3SK043020010B01
	8 m	DD	BSB 35-50 Amphenol 4-pol.	Standard	7S3SK083020010B01
	4 m	DD	BSB 35-50 Amphenol 4-pol.	High Flex Leder	7S3SH043020010B01
	8 m	DD	BSB 35-50 Amphenol 4-pol.	High Flex Leder	7S3SH083020010B01
ABITIG® 26F	4 m	DD	BSB 35-50 Amphenol 4-pol.	Standard	7S3FK043020010B01
	8 m	DD	BSB 35-50 Amphenol 4-pol.	Standard	7S3FK083020010B01
	4 m	DD	BSB 35-50 Amphenol 4-pol.	High Flex Leder	7S3FH043020010B01
	8 m	DD	BSB 35-50 Amphenol 4-pol.	High Flex Leder	7S3FH083020010B01
ABITIG® 24G	4 m	DD	BSB 35-50 Amphenol 4-pol.	Standard	7S8SK043020010B01
	8 m	DD	BSB 35-50 Amphenol 4-pol.	Standard	7S8SK083020010B01
	4 m	DD	BSB 35-50 Amphenol 4-pol.	High Flex Leder	7S8SH043020010B01
	8 m	DD	BSB 35-50 Amphenol 4-pol.	High Flex Leder	7S8SH083020010B01
ABITIG® 200	4 m	DD	BSB 35-50 Amphenol 4-pol.	Standard	7T4SK043020010B01
	8 m	DD	BSB 35-50 Amphenol 4-pol.	Standard	7T4SK083020010B01
	4 m	DD	BSB 35-50 Amphenol 4-pol.	High Flex Leder	7T4SH043020010B01
	8 m	DD	BSB 35-50 Amphenol 4-pol.	High Flex Leder	7T4SH083020010B01
ABITIG® 200F	4 m	DD	BSB 35-50 Amphenol 4-pol.	Standard	7T4FK043020010B01
	8 m	DD	BSB 35-50 Amphenol 4-pol.	Standard	7T4FK083020010B01
	4 m	DD	BSB 35-50 Amphenol 4-pol.	High Flex Leder	7T4FH043020010B01
	8 m	DD	BSB 35-50 Amphenol 4-pol.	High Flex Leder	7T4FH083020010B01
ABITIG® 150	4 m	DD	BSB 35-50 Amphenol 4-pol.	Standard	7T6SK043020010B01
	8 m	DD	BSB 35-50 Amphenol 4-pol.	Standard	7T6SK083020010B01
	4 m	DD	BSB 35-50 Amphenol 4-pol.	High Flex Leder	7T6SH043020010B01
	8 m	DD	BSB 35-50 Amphenol 4-pol.	High Flex Leder	7T6SH083020010B01
ABITIG® 150F	4 m	DD	BSB 35-50 Amphenol 4-pol.	Standard	7T6FK043020010B01
	8 m	DD	BSB 35-50 Amphenol 4-pol.	Standard	7T6FK083020010B01
	4 m	DD	BSB 35-50 Amphenol 4-pol.	High Flex Leder	7T6FH043020010B01
	8 m	DD	BSB 35-50 Amphenol 4-pol.	High Flex Leder	7T6FH083020010B01

ABITIG®-Brennerpreisliste

passend für WIG-Stromquellen des Fabrikates „utp“



Brennertyp	Länge	Schalterfunktion	maschinenseitiger Anschluss	Schlauchpaketausführung	Bestellnummer
ABITIG® 9	4 m	ED	BSB 35-50 Amphenol 4-pol.	Standard	7S1SK043010010A01
	8 m	ED	BSB 35-50 Amphenol 4-pol.	Standard	7S1SK083010010A01
	4 m	ED	BSB 35-50 Amphenol 4-pol.	High Flex Leder	7S1SH043010010A01
	8 m	ED	BSB 35-50 Amphenol 4-pol.	High Flex Leder	7S1SH083010010A01
ABITIG® 9F	4 m	ED	BSB 35-50 Amphenol 4-pol.	Standard	7S1FK043010010A01
	8 m	ED	BSB 35-50 Amphenol 4-pol.	Standard	7S1FK083010010A01
	4 m	ED	BSB 35-50 Amphenol 4-pol.	High Flex Leder	7S1FH043010010A01
	8 m	ED	BSB 35-50 Amphenol 4-pol.	High Flex Leder	7S1FH083010010A01
ABITIG® 17	4 m	ED	BSB 35-50 Amphenol 4-pol.	Standard	7S2SK043010010A01
	8 m	ED	BSB 35-50 Amphenol 4-pol.	Standard	7S2SK083010010A01
	4 m	ED	BSB 35-50 Amphenol 4-pol.	High Flex Leder	7S2SH043010010A01
	8 m	ED	BSB 35-50 Amphenol 4-pol.	High Flex Leder	7S2SH083010010A01
ABITIG® 17F	4 m	ED	BSB 35-50 Amphenol 4-pol.	Standard	7S2FK043010010A01
	8 m	ED	BSB 35-50 Amphenol 4-pol.	Standard	7S2FK083010010A01
	4 m	ED	BSB 35-50 Amphenol 4-pol.	High Flex Leder	7S2FH043010010A01
	8 m	ED	BSB 35-50 Amphenol 4-pol.	High Flex Leder	7S2FH083010010A01

Technische Änderungen vorbehalten • Verkaufspreise = unverbindliche Preisempfehlung - Angebot freibleibend • © Copyright

ABITIG®-Brennerpreisliste

passend für WIG-Stromquellen des Fabrikates „utp“

Brennertyp	Länge	Schalterfunktion	maschinenseitiger Anschluss	Schlauchpaketausführung	Bestellnummer
ABITIG® 26	4 m	ED	BSB 35-50 Amphenol 4-pol.	Standard	7S3SK043010010A01
	8 m	ED	BSB 35-50 Amphenol 4-pol.	Standard	7S3SK083010010A01
	4 m	ED	BSB 35-50 Amphenol 4-pol.	High Flex Leder	7S3SH043010010A01
	8 m	ED	BSB 35-50 Amphenol 4-pol.	High Flex Leder	7S3SH083010010A01
ABITIG® 26F	4 m	ED	BSB 35-50 Amphenol 4-pol.	Standard	7S3FK043010010A01
	8 m	ED	BSB 35-50 Amphenol 4-pol.	Standard	7S3FK083010010A01
	4 m	ED	BSB 35-50 Amphenol 4-pol.	High Flex Leder	7S3FH043010010A01
	8 m	ED	BSB 35-50 Amphenol 4-pol.	High Flex Leder	7S3FH083010010A01
ABITIG® 24G	4 m	ED	BSB 35-50 Amphenol 4-pol.	Standard	7S8SK043010010A01
	8 m	ED	BSB 35-50 Amphenol 4-pol.	Standard	7S8SK083010010A01
	4 m	ED	BSB 35-50 Amphenol 4-pol.	High Flex Leder	7S8SH043010010A01
	8 m	ED	BSB 35-50 Amphenol 4-pol.	High Flex Leder	7S8SH083010010A01
ABITIG® 200	4 m	ED	BSB 35-50 Amphenol 4-pol.	Standard	7T4SK043010010A01
	8 m	ED	BSB 35-50 Amphenol 4-pol.	Standard	7T4SK083010010A01
	4 m	ED	BSB 35-50 Amphenol 4-pol.	High Flex Leder	7T4SH043010010A01
	8 m	ED	BSB 35-50 Amphenol 4-pol.	High Flex Leder	7T4SH083010010A01
ABITIG® 200F	4 m	ED	BSB 35-50 Amphenol 4-pol.	Standard	7T4FK043010010A01
	8 m	ED	BSB 35-50 Amphenol 4-pol.	Standard	7T4FK083010010A01
	4 m	ED	BSB 35-50 Amphenol 4-pol.	High Flex Leder	7T4FH043010010A01
	8 m	ED	BSB 35-50 Amphenol 4-pol.	High Flex Leder	7T4FH083010010A01
ABITIG® 150	4 m	ED	BSB 35-50 Amphenol 4-pol.	Standard	7T6SK043010010A01
	8 m	ED	BSB 35-50 Amphenol 4-pol.	Standard	7T6SK083010010A01
	4 m	ED	BSB 35-50 Amphenol 4-pol.	High Flex Leder	7T6SH043010010A01
	8 m	ED	BSB 35-50 Amphenol 4-pol.	High Flex Leder	7T6SH083010010A01
ABITIG® 150F	4 m	ED	BSB 35-50 Amphenol 4-pol.	Standard	7T6FK043010010A01
	8 m	ED	BSB 35-50 Amphenol 4-pol.	Standard	7T6FK083010010A01
	4 m	ED	BSB 35-50 Amphenol 4-pol.	High Flex Leder	7T6FH043010010A01
	8 m	ED	BSB 35-50 Amphenol 4-pol.	High Flex Leder	7T6FH083010010A01

ABITIG®-Brennerpreisliste

passend für WIG-Stromquellen des Fabrikates „utp“



Brennertyp	Länge	Schalterfunktion	maschinenseitiger Anschluss	Schlauchpaketausführung	Bestellnummer
ABITIG® 9	4 m	ED	BSB 35-50 Tuchel 5-pol.	Standard	7S1SK043010002A01
	8 m	ED	BSB 35-50 Tuchel 5-pol.	Standard	7S1SK083010002A01
	4 m	ED	BSB 35-50 Tuchel 5-pol.	High Flex Leder	7S1SH043010002A01
	8 m	ED	BSB 35-50 Tuchel 5-pol.	High Flex Leder	7S1SH083010002A01

ABITIG® 9F	4 m	ED	BSB 35-50 Tuchel 5-pol.	Standard	7S1FK043010002A01
	8 m	ED	BSB 35-50 Tuchel 5-pol.	Standard	7S1FK083010002A01
	4 m	ED	BSB 35-50 Tuchel 5-pol.	High Flex Leder	7S1FH043010002A01
	8 m	ED	BSB 35-50 Tuchel 5-pol.	High Flex Leder	7S1FH083010002A01

ABITIG® 17	4 m	ED	BSB 35-50 Tuchel 5-pol.	Standard	7S2SK043010002A01
	8 m	ED	BSB 35-50 Tuchel 5-pol.	Standard	7S2SK083010002A01
	4 m	ED	BSB 35-50 Tuchel 5-pol.	High Flex Leder	7S2SH043010002A01
	8 m	ED	BSB 35-50 Tuchel 5-pol.	High Flex Leder	7S2SH083010002A01

ABITIG® 17F	4 m	ED	BSB 35-50 Tuchel 5-pol.	Standard	7S2FK043010002A01
	8 m	ED	BSB 35-50 Tuchel 5-pol.	Standard	7S2FK083010002A01
	4 m	ED	BSB 35-50 Tuchel 5-pol.	High Flex Leder	7S2FH043010002A01
	8 m	ED	BSB 35-50 Tuchel 5-pol.	High Flex Leder	7S2FH083010002A01

Technische Änderungen vorbehalten • Verkaufspreise = unverbindliche Preisempfehlung - Angebot freibleibend • © Copyright

ABITIG®-Brennerpreisliste

passend für WIG-Stromquellen des Fabrikates „utp“

Brennertyp	Länge	Schalterfunktion	maschinenseitiger Anschluss	Schlauchpaketausführung	Bestellnummer
ABITIG® 26	4 m	ED	BSB 35-50 Tuchel 5-pol.	Standard	7S3SK043010002A01
	8 m	ED	BSB 35-50 Tuchel 5-pol.	Standard	7S3SK083010002A01
	4 m	ED	BSB 35-50 Tuchel 5-pol.	High Flex Leder	7S3SH043010002A01
	8 m	ED	BSB 35-50 Tuchel 5-pol.	High Flex Leder	7S3SH083010002A01
ABITIG® 26F	4 m	ED	BSB 35-50 Tuchel 5-pol.	Standard	7S3FK043010002A01
	8 m	ED	BSB 35-50 Tuchel 5-pol.	Standard	7S3FK083010002A01
	4 m	ED	BSB 35-50 Tuchel 5-pol.	High Flex Leder	7S3FH043010002A01
	8 m	ED	BSB 35-50 Tuchel 5-pol.	High Flex Leder	7S3FH083010002A01
ABITIG® 24G	4 m	ED	BSB 35-50 Tuchel 5-pol.	Standard	7S8SK043010002A01
	8 m	ED	BSB 35-50 Tuchel 5-pol.	Standard	7S8SK083010002A01
	4 m	ED	BSB 35-50 Tuchel 5-pol.	High Flex Leder	7S8SH043010002A01
	8 m	ED	BSB 35-50 Tuchel 5-pol.	High Flex Leder	7S8SH083010002A01
ABITIG® 200	4 m	ED	BSB 35-50 Tuchel 5-pol.	Standard	7T4SK043010002A01
	8 m	ED	BSB 35-50 Tuchel 5-pol.	Standard	7T4SK083010002A01
	4 m	ED	BSB 35-50 Tuchel 5-pol.	High Flex Leder	7T4SH043010002A01
	8 m	ED	BSB 35-50 Tuchel 5-pol.	High Flex Leder	7T4SH083010002A01
ABITIG® 200F	4 m	ED	BSB 35-50 Tuchel 5-pol.	Standard	7T4FK043010002A01
	8 m	ED	BSB 35-50 Tuchel 5-pol.	Standard	7T4FK083010002A01
	4 m	ED	BSB 35-50 Tuchel 5-pol.	High Flex Leder	7T4FH043010002A01
	8 m	ED	BSB 35-50 Tuchel 5-pol.	High Flex Leder	7T4FH083010002A01
ABITIG® 150	4 m	ED	BSB 35-50 Tuchel 5-pol.	Standard	7T6SK043010002A01
	8 m	ED	BSB 35-50 Tuchel 5-pol.	Standard	7T6SK083010002A01
	4 m	ED	BSB 35-50 Tuchel 5-pol.	High Flex Leder	7T6SH043010002A01
	8 m	ED	BSB 35-50 Tuchel 5-pol.	High Flex Leder	7T6SH083010002A01
ABITIG® 150F	4 m	ED	BSB 35-50 Tuchel 5-pol.	Standard	7T6FK043010002A01
	8 m	ED	BSB 35-50 Tuchel 5-pol.	Standard	7T6FK083010002A01
	4 m	ED	BSB 35-50 Tuchel 5-pol.	High Flex Leder	7T6FH043010002A01
	8 m	ED	BSB 35-50 Tuchel 5-pol.	High Flex Leder	7T6FH083010002A01

ABITIG®-Brennerpreisliste

passend für WIG-Stromquellen des Fabrikates „utp“



Brennertyp	Länge	Schalterfunktion	maschinenseitiger Anschluss	Schlauchpaketausführung	Bestellnummer
ABITIG® 18	4 m	DD	BSB 35-50 Amphenol 4-pol.	Standard	7S4SK043020010B11
	8 m	DD	BSB 35-50 Amphenol 4-pol.	Standard	7S4SK083020010B11
	4 m	DD	BSB 35-50 Amphenol 4-pol.	High Flex Leder	7S4SH043020010B11
	8 m	DD	BSB 35-50 Amphenol 4-pol.	High Flex Leder	7S4SH083020010B11
ABITIG® 18F	4 m	DD	BSB 35-50 Amphenol 4-pol.	Standard	7S4FK043020010B11
	8 m	DD	BSB 35-50 Amphenol 4-pol.	Standard	7S4FK083020010B11
	4 m	DD	BSB 35-50 Amphenol 4-pol.	High Flex Leder	7S4FH043020010B11
	8 m	DD	BSB 35-50 Amphenol 4-pol.	High Flex Leder	7S4FH083020010B11
ABITIG® 20	4 m	DD	BSB 35-50 Amphenol 4-pol.	Standard	7S5SK043020010B11
	8 m	DD	BSB 35-50 Amphenol 4-pol.	Standard	7S5SK083020010B11
	4 m	DD	BSB 35-50 Amphenol 4-pol.	High Flex Leder	7S5SH043020010B11
	8 m	DD	BSB 35-50 Amphenol 4-pol.	High Flex Leder	7S5SH083020010B11
ABITIG® 20F	4 m	DD	BSB 35-50 Amphenol 4-pol.	Standard	7S5FK043020010B11
	8 m	DD	BSB 35-50 Amphenol 4-pol.	Standard	7S5FK083020010B11
	4 m	DD	BSB 35-50 Amphenol 4-pol.	High Flex Leder	7S5FH043020010B11
	8 m	DD	BSB 35-50 Amphenol 4-pol.	High Flex Leder	7S5FH083020010B11

Technische Änderungen vorbehalten • Verkaufspreise = unverbindliche Preisempfehlung - Angebot freibleibend • © Copyright

ABITIG®-Brennerpreisliste

passend für WIG-Stromquellen des Fabrikates „utp“

Brennertyp	Länge	Schalterfunktion	maschinenseitiger Anschluss	Schlauchpaketausführung	Bestellnummer
ABITIG® 12-1	4 m	DD	BSB 35-50 Amphenol 4-pol.	Standard	7S6SK043020010B11
	8 m	DD	BSB 35-50 Amphenol 4-pol.	Standard	7S6SK083020010B11
	4 m	DD	BSB 35-50 Amphenol 4-pol.	High Flex Leder	7S6SH043020010B11
	8 m	DD	BSB 35-50 Amphenol 4-pol.	High Flex Leder	7S6SH083020010B11
ABITIG® 18SC	4 m	DD	BSB 35-50 Amphenol 4-pol.	Standard	7S7SK043020010B11
	8 m	DD	BSB 35-50 Amphenol 4-pol.	Standard	7S7SK083020010B11
	4 m	DD	BSB 35-50 Amphenol 4-pol.	High Flex Leder	7S7SH043020010B11
	8 m	DD	BSB 35-50 Amphenol 4-pol.	High Flex Leder	7S7SH083020010B11
ABITIG® 24W	4 m	DD	BSB 35-50 Amphenol 4-pol.	Standard	7S9SK043020010B11
	8 m	DD	BSB 35-50 Amphenol 4-pol.	Standard	7S9SK083020010B11
	4 m	DD	BSB 35-50 Amphenol 4-pol.	High Flex Leder	7S9SH043020010B11
	8 m	DD	BSB 35-50 Amphenol 4-pol.	High Flex Leder	7S9SH083020010B11
ABITIG® 450W	4 m	DD	BSB 35-50 Amphenol 4-pol.	Standard	7T5SK043020110B11
	8 m	DD	BSB 35-50 Amphenol 4-pol.	Standard	7T5SK083020110B11
	4 m	DD	BSB 35-50 Amphenol 4-pol.	High Flex Leder	7T5SH043020110B11
	8 m	DD	BSB 35-50 Amphenol 4-pol.	High Flex Leder	7T5SH083020110B11
ABITIG® 260W	4 m	DD	BSB 35-50 Amphenol 4-pol.	Standard	7T7SK043020110B11
	8 m	DD	BSB 35-50 Amphenol 4-pol.	Standard	7T7SK083020110B11
	4 m	DD	BSB 35-50 Amphenol 4-pol.	High Flex Leder	7T7SH043020110B11
	8 m	DD	BSB 35-50 Amphenol 4-pol.	High Flex Leder	7T7SH083020110B11
ABITIG® 450W SC	4 m	DD	BSB 35-50 Amphenol 4-pol.	Standard	
	8 m	DD	BSB 35-50 Amphenol 4-pol.	Standard	
	4 m	DD	BSB 35-50 Amphenol 4-pol.	High Flex Leder	7T8SH043020110B11
	8 m	DD	BSB 35-50 Amphenol 4-pol.	High Flex Leder	7T8SH083020110B11

ABITIG®-Brennerpreisliste

passend für WIG-Stromquellen des Fabrikates „utp“



Brennertyp	Länge	Schalterfunktion	maschinenseitiger Anschluss	Schlauchpaketausführung	Bestellnummer
ABITIG® 18	4 m	ED	BSB 35-50 Amphenol 4-pol.	Standard	7S4SK043010010A11
	8 m	ED	BSB 35-50 Amphenol 4-pol.	Standard	7S4SK083010010A11
	4 m	ED	BSB 35-50 Amphenol 4-pol.	High Flex Leder	7S4SH043010010A11
	8 m	ED	BSB 35-50 Amphenol 4-pol.	High Flex Leder	7S4SH083010010A11
ABITIG® 18F	4 m	ED	BSB 35-50 Amphenol 4-pol.	Standard	7S4FK043010010A11
	8 m	ED	BSB 35-50 Amphenol 4-pol.	Standard	7S4FK083010010A11
	4 m	ED	BSB 35-50 Amphenol 4-pol.	High Flex Leder	7S4FH043010010A11
	8 m	ED	BSB 35-50 Amphenol 4-pol.	High Flex Leder	7S4FH083010010A11
ABITIG® 20	4 m	ED	BSB 35-50 Amphenol 4-pol.	Standard	7S5SK043010010A11
	8 m	ED	BSB 35-50 Amphenol 4-pol.	Standard	7S5SK083010010A11
	4 m	ED	BSB 35-50 Amphenol 4-pol.	High Flex Leder	7S5SH043010010A11
	8 m	ED	BSB 35-50 Amphenol 4-pol.	High Flex Leder	7S5SH083010010A11
ABITIG® 20F	4 m	ED	BSB 35-50 Amphenol 4-pol.	Standard	7S5FK043010010A11
	8 m	ED	BSB 35-50 Amphenol 4-pol.	Standard	7S5FK083010010A11
	4 m	ED	BSB 35-50 Amphenol 4-pol.	High Flex Leder	7S5FH043010010A11
	8 m	ED	BSB 35-50 Amphenol 4-pol.	High Flex Leder	7S5FH083010010A11

Technische Änderungen vorbehalten • Verkaufspreise = unverbindliche Preisempfehlung - Angebot freibleibend • © Copyright

ABITIG®-Brennerpreisliste

passend für WIG-Stromquellen des Fabrikates „utp“

Brennertyp	Länge	Schalterfunktion	maschinenseitiger Anschluss	Schlauchpaketausführung	Bestellnummer
ABITIG® 12-1	4 m	ED	BSB 35-50 Amphenol 4-pol.	Standard	7S6SK043010010A11
	8 m	ED	BSB 35-50 Amphenol 4-pol.	Standard	7S6SK083010010A11
	4 m	ED	BSB 35-50 Amphenol 4-pol.	High Flex Leder	7S6SH043010010A11
	8 m	ED	BSB 35-50 Amphenol 4-pol.	High Flex Leder	7S6SH083010010A11

ABITIG® 18SC	4 m	ED	BSB 35-50 Amphenol 4-pol.	Standard	7S7SK043010010A11
	8 m	ED	BSB 35-50 Amphenol 4-pol.	Standard	7S7SK083010010A11
	4 m	ED	BSB 35-50 Amphenol 4-pol.	High Flex Leder	7S7SH043010010A11
	8 m	ED	BSB 35-50 Amphenol 4-pol.	High Flex Leder	7S7SH083010010A11

ABITIG® 24W	4 m	ED	BSB 35-50 Amphenol 4-pol.	Standard	7S9SK043010010A11
	8 m	ED	BSB 35-50 Amphenol 4-pol.	Standard	7S9SK083010010A11
	4 m	ED	BSB 35-50 Amphenol 4-pol.	High Flex Leder	7S9SH043010010A11
	8 m	ED	BSB 35-50 Amphenol 4-pol.	High Flex Leder	7S9SH083010010A11

ABITIG® 450W	4 m	ED	BSB 35-50 Amphenol 4-pol.	Standard	7T5SK043010110A11
	8 m	ED	BSB 35-50 Amphenol 4-pol.	Standard	7T5SK083010110A11
	4 m	ED	BSB 35-50 Amphenol 4-pol.	High Flex Leder	7T5SH043010110A11
	8 m	ED	BSB 35-50 Amphenol 4-pol.	High Flex Leder	7T5SH083010110A11

ABITIG® 260W	4 m	ED	BSB 35-50 Amphenol 4-pol.	Standard	7T7SK043010110A11
	8 m	ED	BSB 35-50 Amphenol 4-pol.	Standard	7T7SK083010110A11
	4 m	ED	BSB 35-50 Amphenol 4-pol.	High Flex Leder	7T7SH043010110A11
	8 m	ED	BSB 35-50 Amphenol 4-pol.	High Flex Leder	7T7SH083010110A11

ABITIG® 450W SC	4 m	ED	BSB 35-50 Amphenol 4-pol.	Standard	
	8 m	ED	BSB 35-50 Amphenol 4-pol.	Standard	
	4 m	ED	BSB 35-50 Amphenol 4-pol.	High Flex Leder	7T8SH043010110A11
	8 m	ED	BSB 35-50 Amphenol 4-pol.	High Flex Leder	7T8SH083010110A11

ABITIG®-Brennerpreisliste

passend für WIG-Stromquellen des Fabrikates „weco“



Brennertyp	Länge	Schalterfunktion	maschinenseitiger Anschluss	Schlauchpaketausführung	Bestellnummer
ABITIG® 9	4 m	ED	BSB 10-25 Rundsteckverb. 5-pol.	Standard	7S1SK043012235A54
	8 m	ED	BSB 10-25 Rundsteckverb. 5-pol.	Standard	7S1SK083012235A54
	4 m	ED	BSB 10-25 Rundsteckverb. 5-pol.	High Flex Leder	7S1SH043012235A54
	8 m	ED	BSB 10-25 Rundsteckverb. 5-pol.	High Flex Leder	7S1SH083012235A54

ABITIG® 9F	4 m	ED	BSB 10-25 Rundsteckverb. 5-pol.	Standard	7S1FK043012235A54
	8 m	ED	BSB 10-25 Rundsteckverb. 5-pol.	Standard	7S1FK083012235A54
	4 m	ED	BSB 10-25 Rundsteckverb. 5-pol.	High Flex Leder	7S1FH043012235A54
	8 m	ED	BSB 10-25 Rundsteckverb. 5-pol.	High Flex Leder	7S1FH083012235A54

ABITIG® 17	4 m	ED	BSB 10-25 Rundsteckverb. 5-pol.	Standard	7S2SK043012235A54
	8 m	ED	BSB 10-25 Rundsteckverb. 5-pol.	Standard	7S2SK083012235A54
	4 m	ED	BSB 10-25 Rundsteckverb. 5-pol.	High Flex Leder	7S2SH043012235A54
	8 m	ED	BSB 10-25 Rundsteckverb. 5-pol.	High Flex Leder	7S2SH083012235A54

ABITIG® 17F	4 m	ED	BSB 10-25 Rundsteckverb. 5-pol.	Standard	7S2FK043012235A54
	8 m	ED	BSB 10-25 Rundsteckverb. 5-pol.	Standard	7S2FK083012235A54
	4 m	ED	BSB 10-25 Rundsteckverb. 5-pol.	High Flex Leder	7S2FH043012235A54
	8 m	ED	BSB 10-25 Rundsteckverb. 5-pol.	High Flex Leder	7S2FH083012235A54

Technische Änderungen vorbehalten • Verkaufspreise = unverbindliche Preisempfehlung - Angebot freibleibend • © Copyright

ABITIG®-Brennerpreisliste

passend für WIG-Stromquellen des Fabrikates „weco“

Brennertyp	Länge	Schalterfunktion	maschinenseitiger Anschluss	Schlauchpaketausführung	Bestellnummer
ABITIG® 26	4 m	ED	BSB 10-25 Rundsteckverb. 5-pol.	Standard	7S3SK043012235A54
	8 m	ED	BSB 10-25 Rundsteckverb. 5-pol.	Standard	7S3SK083012235A54
	4 m	ED	BSB 10-25 Rundsteckverb. 5-pol.	High Flex Leder	7S3SH043012235A54
	8 m	ED	BSB 10-25 Rundsteckverb. 5-pol.	High Flex Leder	7S3SH083012235A54
ABITIG® 26F	4 m	ED	BSB 10-25 Rundsteckverb. 5-pol.	Standard	7S3FK043012235A54
	8 m	ED	BSB 10-25 Rundsteckverb. 5-pol.	Standard	7S3FK083012235A54
	4 m	ED	BSB 10-25 Rundsteckverb. 5-pol.	High Flex Leder	7S3FH043012235A54
	8 m	ED	BSB 10-25 Rundsteckverb. 5-pol.	High Flex Leder	7S3FH083012235A54
ABITIG® 24G	4 m	ED	BSB 10-25 Rundsteckverb. 5-pol.	Standard	7S8SK043012235A54
	8 m	ED	BSB 10-25 Rundsteckverb. 5-pol.	Standard	7S8SK083012235A54
	4 m	ED	BSB 10-25 Rundsteckverb. 5-pol.	High Flex Leder	7S8SH043012235A54
	8 m	ED	BSB 10-25 Rundsteckverb. 5-pol.	High Flex Leder	7S8SH083012235A54
ABITIG® 200	4 m	ED	BSB 10-25 Rundsteckverb. 5-pol.	Standard	7T4SK043012235A54
	8 m	ED	BSB 10-25 Rundsteckverb. 5-pol.	Standard	7T4SK083012235A54
	4 m	ED	BSB 10-25 Rundsteckverb. 5-pol.	High Flex Leder	7T4SH043012235A54
	8 m	ED	BSB 10-25 Rundsteckverb. 5-pol.	High Flex Leder	7T4SH083012235A54
ABITIG® 200F	4 m	ED	BSB 10-25 Rundsteckverb. 5-pol.	Standard	7T4FK043012235A54
	8 m	ED	BSB 10-25 Rundsteckverb. 5-pol.	Standard	7T4FK083012235A54
	4 m	ED	BSB 10-25 Rundsteckverb. 5-pol.	High Flex Leder	7T4FH043012235A54
	8 m	ED	BSB 10-25 Rundsteckverb. 5-pol.	High Flex Leder	7T4FH083012235A54
ABITIG® 150	4 m	ED	BSB 10-25 Rundsteckverb. 5-pol.	Standard	7T6SK043012235A54
	8 m	ED	BSB 10-25 Rundsteckverb. 5-pol.	Standard	7T6SK083012235A54
	4 m	ED	BSB 10-25 Rundsteckverb. 5-pol.	High Flex Leder	7T6SH043012235A54
	8 m	ED	BSB 10-25 Rundsteckverb. 5-pol.	High Flex Leder	7T6SH083012235A54
ABITIG® 150F	4 m	ED	BSB 10-25 Rundsteckverb. 5-pol.	Standard	7T6FK043012235A54
	8 m	ED	BSB 10-25 Rundsteckverb. 5-pol.	Standard	7T6FK083012235A54
	4 m	ED	BSB 10-25 Rundsteckverb. 5-pol.	High Flex Leder	7T6FH043012235A54
	8 m	ED	BSB 10-25 Rundsteckverb. 5-pol.	High Flex Leder	7T6FH083012235A54

ABITIG®-Brennerpreisliste

passend für WIG-Stromquellen des Fabrikates „weco“

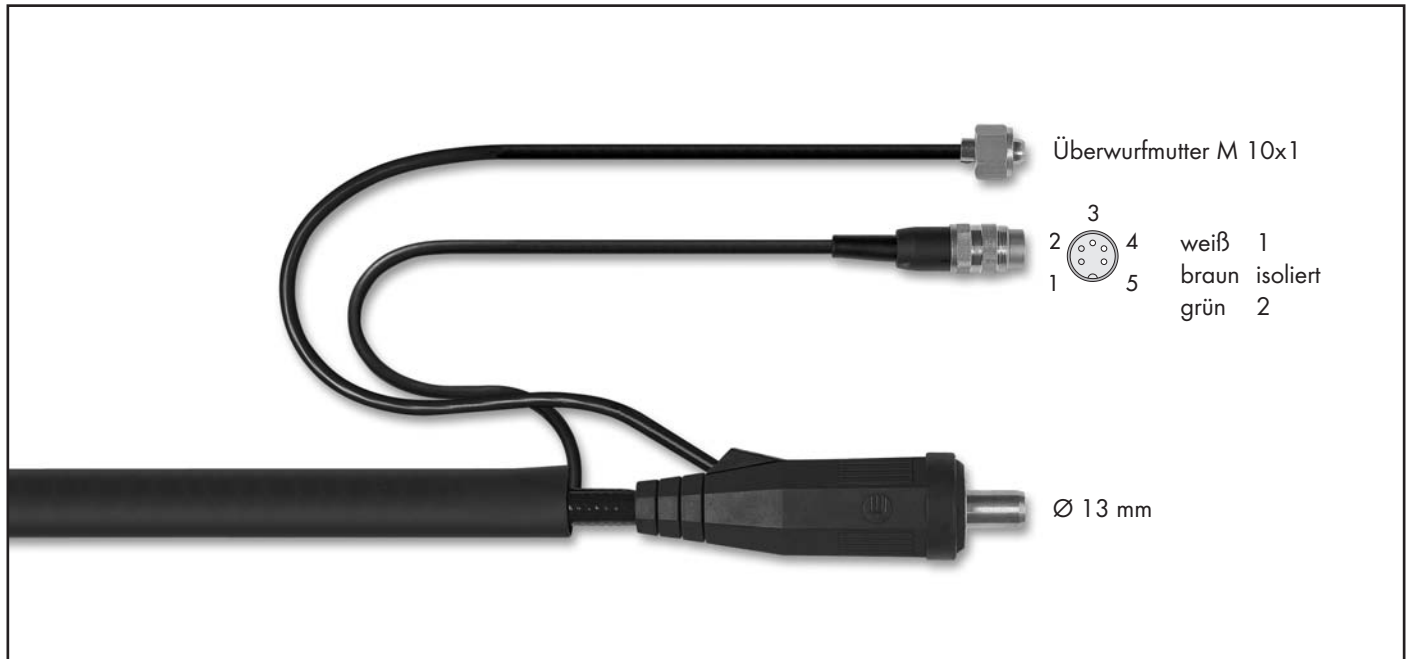

Brennertyp	Länge	Schalterfunktion	maschinenseitiger Anschluss	Schlauchpaketausführung	Bestellnummer
ABITIG® 9	4 m	ED	BSB 35-50 Rundsteckverb. 5-pol.	Standard	7S1SK043010035A54
	8 m	ED	BSB 35-50 Rundsteckverb. 5-pol.	Standard	7S1SK083010035A54
	4 m	ED	BSB 35-50 Rundsteckverb. 5-pol.	High Flex Leder	7S1SH043010035A54
	8 m	ED	BSB 35-50 Rundsteckverb. 5-pol.	High Flex Leder	7S1SH083010035A54
ABITIG® 9F	4 m	ED	BSB 35-50 Rundsteckverb. 5-pol.	Standard	7S1FK043010035A54
	8 m	ED	BSB 35-50 Rundsteckverb. 5-pol.	Standard	7S1FK083010035A54
	4 m	ED	BSB 35-50 Rundsteckverb. 5-pol.	High Flex Leder	7S1FH043010035A54
	8 m	ED	BSB 35-50 Rundsteckverb. 5-pol.	High Flex Leder	7S1FH083010035A54
ABITIG® 17	4 m	ED	BSB 35-50 Rundsteckverb. 5-pol.	Standard	7S2SK043010035A54
	8 m	ED	BSB 35-50 Rundsteckverb. 5-pol.	Standard	7S2SK083010035A54
	4 m	ED	BSB 35-50 Rundsteckverb. 5-pol.	High Flex Leder	7S2SH043010035A54
	8 m	ED	BSB 35-50 Rundsteckverb. 5-pol.	High Flex Leder	7S2SH083010035A54
ABITIG® 17F	4 m	ED	BSB 35-50 Rundsteckverb. 5-pol.	Standard	7S2FK043010035A54
	8 m	ED	BSB 35-50 Rundsteckverb. 5-pol.	Standard	7S2FK083010035A54
	4 m	ED	BSB 35-50 Rundsteckverb. 5-pol.	High Flex Leder	7S2FH043010035A54
	8 m	ED	BSB 35-50 Rundsteckverb. 5-pol.	High Flex Leder	7S2FH083010035A54

Technische Änderungen vorbehalten • Verkaufspreise = unverbindliche Preisempfehlung - Angebot freibleibend • © Copyright

ABITIG®-Brennerpreisliste

passend für WIG-Stromquellen des Fabrikates „weco“

Brennertyp	Länge	Schalterfunktion	maschinenseitiger Anschluss	Schlauchpaketausführung	Bestellnummer
ABITIG® 26	4 m	ED	BSB 35-50 Rundsteckverb. 5-pol.	Standard	7S3SK043010035A54
	8 m	ED	BSB 35-50 Rundsteckverb. 5-pol.	Standard	7S3SK083010035A54
	4 m	ED	BSB 35-50 Rundsteckverb. 5-pol.	High Flex Leder	7S3SH043010035A54
	8 m	ED	BSB 35-50 Rundsteckverb. 5-pol.	High Flex Leder	7S3SH083010035A54
ABITIG® 26F	4 m	ED	BSB 35-50 Rundsteckverb. 5-pol.	Standard	7S3FK043010035A54
	8 m	ED	BSB 35-50 Rundsteckverb. 5-pol.	Standard	7S3FK083010035A54
	4 m	ED	BSB 35-50 Rundsteckverb. 5-pol.	High Flex Leder	7S3FH043010035A54
	8 m	ED	BSB 35-50 Rundsteckverb. 5-pol.	High Flex Leder	7S3FH083010035A54
ABITIG® 24G	4 m	ED	BSB 35-50 Rundsteckverb. 5-pol.	Standard	7S8SK043010035A54
	8 m	ED	BSB 35-50 Rundsteckverb. 5-pol.	Standard	7S8SK083010035A54
	4 m	ED	BSB 35-50 Rundsteckverb. 5-pol.	High Flex Leder	7S8SH043010035A54
	8 m	ED	BSB 35-50 Rundsteckverb. 5-pol.	High Flex Leder	7S8SH083010035A54
ABITIG® 200	4 m	ED	BSB 35-50 Rundsteckverb. 5-pol.	Standard	7T4SK043010035A54
	8 m	ED	BSB 35-50 Rundsteckverb. 5-pol.	Standard	7T4SK083010035A54
	4 m	ED	BSB 35-50 Rundsteckverb. 5-pol.	High Flex Leder	7T4SH043010035A54
	8 m	ED	BSB 35-50 Rundsteckverb. 5-pol.	High Flex Leder	7T4SH083010035A54
ABITIG® 200F	4 m	ED	BSB 35-50 Rundsteckverb. 5-pol.	Standard	7T4FK043010035A54
	8 m	ED	BSB 35-50 Rundsteckverb. 5-pol.	Standard	7T4FK083010035A54
	4 m	ED	BSB 35-50 Rundsteckverb. 5-pol.	High Flex Leder	7T4FH043010035A54
	8 m	ED	BSB 35-50 Rundsteckverb. 5-pol.	High Flex Leder	7T4FH083010035A54
ABITIG® 150	4 m	ED	BSB 35-50 Rundsteckverb. 5-pol.	Standard	7T6SK043010035A54
	8 m	ED	BSB 35-50 Rundsteckverb. 5-pol.	Standard	7T6SK083010035A54
	4 m	ED	BSB 35-50 Rundsteckverb. 5-pol.	High Flex Leder	7T6SH043010035A54
	8 m	ED	BSB 35-50 Rundsteckverb. 5-pol.	High Flex Leder	7T6SH083010035A54
ABITIG® 150F	4 m	ED	BSB 35-50 Rundsteckverb. 5-pol.	Standard	7T6FK043010035A54
	8 m	ED	BSB 35-50 Rundsteckverb. 5-pol.	Standard	7T6FK083010035A54
	4 m	ED	BSB 35-50 Rundsteckverb. 5-pol.	High Flex Leder	7T6FH043010035A54
	8 m	ED	BSB 35-50 Rundsteckverb. 5-pol.	High Flex Leder	7T6FH083010035A54

ABITIG®-Brennerpreisliste

passend für WIG-Stromquellen des Fabrikates „weltec“

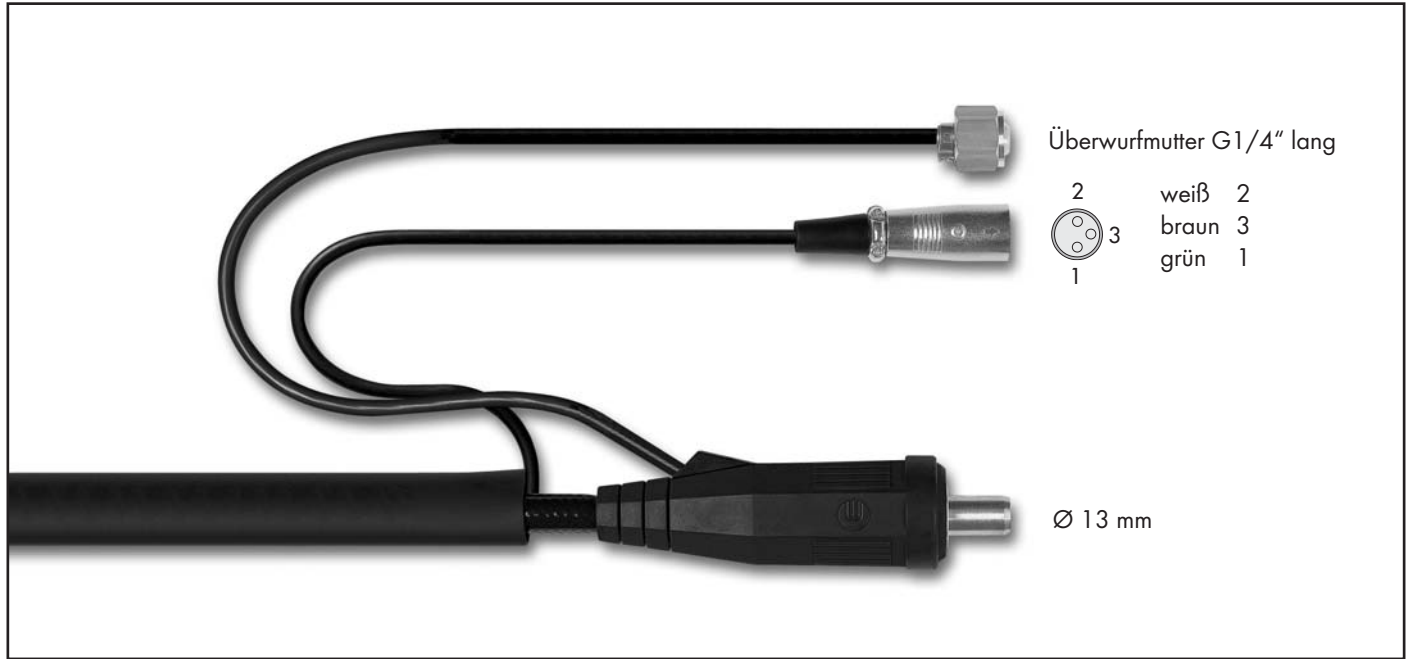

Brennertyp	Länge	Schalterfunktion	maschinenseitiger Anschluss	Schlauchpaketausführung	Bestellnummer
ABITIG® 9	4 m	DD	BSB 35-50 Rundsteckverb. 3-pol.	Standard	7S1SK043020041A51
	8 m	DD	BSB 35-50 Rundsteckverb. 3-pol.	Standard	7S1SK083020041A51
	4 m	DD	BSB 35-50 Rundsteckverb. 3-pol.	High Flex Leder	7S1SH043020041A51
	8 m	DD	BSB 35-50 Rundsteckverb. 3-pol.	High Flex Leder	7S1SH083020041A51
ABITIG® 9F	4 m	DD	BSB 35-50 Rundsteckverb. 3-pol.	Standard	7S1FK043020041A51
	8 m	DD	BSB 35-50 Rundsteckverb. 3-pol.	Standard	7S1FK083020041A01
	4 m	DD	BSB 35-50 Rundsteckverb. 3-pol.	High Flex Leder	7S1FH043020041A51
	8 m	DD	BSB 35-50 Rundsteckverb. 3-pol.	High Flex Leder	7S1FH083020041A51
ABITIG® 17	4 m	DD	BSB 35-50 Rundsteckverb. 3-pol.	Standard	7S2SK043020041A51
	8 m	DD	BSB 35-50 Rundsteckverb. 3-pol.	Standard	7S2SK083020041A51
	4 m	DD	BSB 35-50 Rundsteckverb. 3-pol.	High Flex Leder	7S2SH043020041A51
	8 m	DD	BSB 35-50 Rundsteckverb. 3-pol.	High Flex Leder	7S2SH083020041A51
ABITIG® 17F	4 m	DD	BSB 35-50 Rundsteckverb. 3-pol.	Standard	7S2FK043020041A51
	8 m	DD	BSB 35-50 Rundsteckverb. 3-pol.	Standard	7S2FK083020041A51
	4 m	DD	BSB 35-50 Rundsteckverb. 3-pol.	High Flex Leder	7S2FH043020041A51
	8 m	DD	BSB 35-50 Rundsteckverb. 3-pol.	High Flex Leder	7S2FH083020041A51

Technische Änderungen vorbehalten • Verkaufspreise = unverbindliche Preisempfehlung - Angebot freibleibend • © Copyright

ABITIG®-Brennerpreisliste

passend für WIG-Stromquellen des Fabrikates „weltec“

Brennertyp	Länge	Schalterfunktion	maschinenseitiger Anschluss	Schlauchpaketausführung	Bestellnummer
ABITIG® 26	4 m	DD	BSB 35-50 Rundsteckverb. 3-pol.	Standard	7S3SK043020041A51
	8 m	DD	BSB 35-50 Rundsteckverb. 3-pol.	Standard	7S3SK083020041A51
	4 m	DD	BSB 35-50 Rundsteckverb. 3-pol.	High Flex Leder	7S3SH043020041A51
	8 m	DD	BSB 35-50 Rundsteckverb. 3-pol.	High Flex Leder	7S3SH083020041A51
ABITIG® 26F	4 m	DD	BSB 35-50 Rundsteckverb. 3-pol.	Standard	7S3FK043020041A51
	8 m	DD	BSB 35-50 Rundsteckverb. 3-pol.	Standard	7S3FK083020041A51
	4 m	DD	BSB 35-50 Rundsteckverb. 3-pol.	High Flex Leder	7S3FH043020041A51
	8 m	DD	BSB 35-50 Rundsteckverb. 3-pol.	High Flex Leder	7S3FH083020041A51
ABITIG® 24G	4 m	DD	BSB 35-50 Rundsteckverb. 3-pol.	Standard	7S8SK043020041A51
	8 m	DD	BSB 35-50 Rundsteckverb. 3-pol.	Standard	7S8SK083020041A51
	4 m	DD	BSB 35-50 Rundsteckverb. 3-pol.	High Flex Leder	7S8SH043020041A51
	8 m	DD	BSB 35-50 Rundsteckverb. 3-pol.	High Flex Leder	7S8SH083020041A51
ABITIG® 200	4 m	DD	BSB 35-50 Rundsteckverb. 3-pol.	Standard	7T4SK043020041A51
	8 m	DD	BSB 35-50 Rundsteckverb. 3-pol.	Standard	7T4SK083020041A51
	4 m	DD	BSB 35-50 Rundsteckverb. 3-pol.	High Flex Leder	7T4SH043020041A51
	8 m	DD	BSB 35-50 Rundsteckverb. 3-pol.	High Flex Leder	7T4SH083020041A51
ABITIG® 200F	4 m	DD	BSB 35-50 Rundsteckverb. 3-pol.	Standard	7T4FK043020041A51
	8 m	DD	BSB 35-50 Rundsteckverb. 3-pol.	Standard	7T4FK083020041A51
	4 m	DD	BSB 35-50 Rundsteckverb. 3-pol.	High Flex Leder	7T4FH043020041A51
	8 m	DD	BSB 35-50 Rundsteckverb. 3-pol.	High Flex Leder	7T4FH083020041A51
ABITIG® 150	4 m	DD	BSB 35-50 Rundsteckverb. 3-pol.	Standard	7T6SK043020041A51
	8 m	DD	BSB 35-50 Rundsteckverb. 3-pol.	Standard	7T6SK083020041A51
	4 m	DD	BSB 35-50 Rundsteckverb. 3-pol.	High Flex Leder	7T6SH043020041A51
	8 m	DD	BSB 35-50 Rundsteckverb. 3-pol.	High Flex Leder	7T6SH083020041A51
ABITIG® 150F	4 m	DD	BSB 35-50 Rundsteckverb. 3-pol.	Standard	7T6FK043020041A51
	8 m	DD	BSB 35-50 Rundsteckverb. 3-pol.	Standard	7T6FK083020041A51
	4 m	DD	BSB 35-50 Rundsteckverb. 3-pol.	High Flex Leder	7T6FH043020041A51
	8 m	DD	BSB 35-50 Rundsteckverb. 3-pol.	High Flex Leder	7T6FH083020041A51

ABITIG®-Brennerpreisliste

passend für WIG-Stromquellen des Fabrikates „weltec“

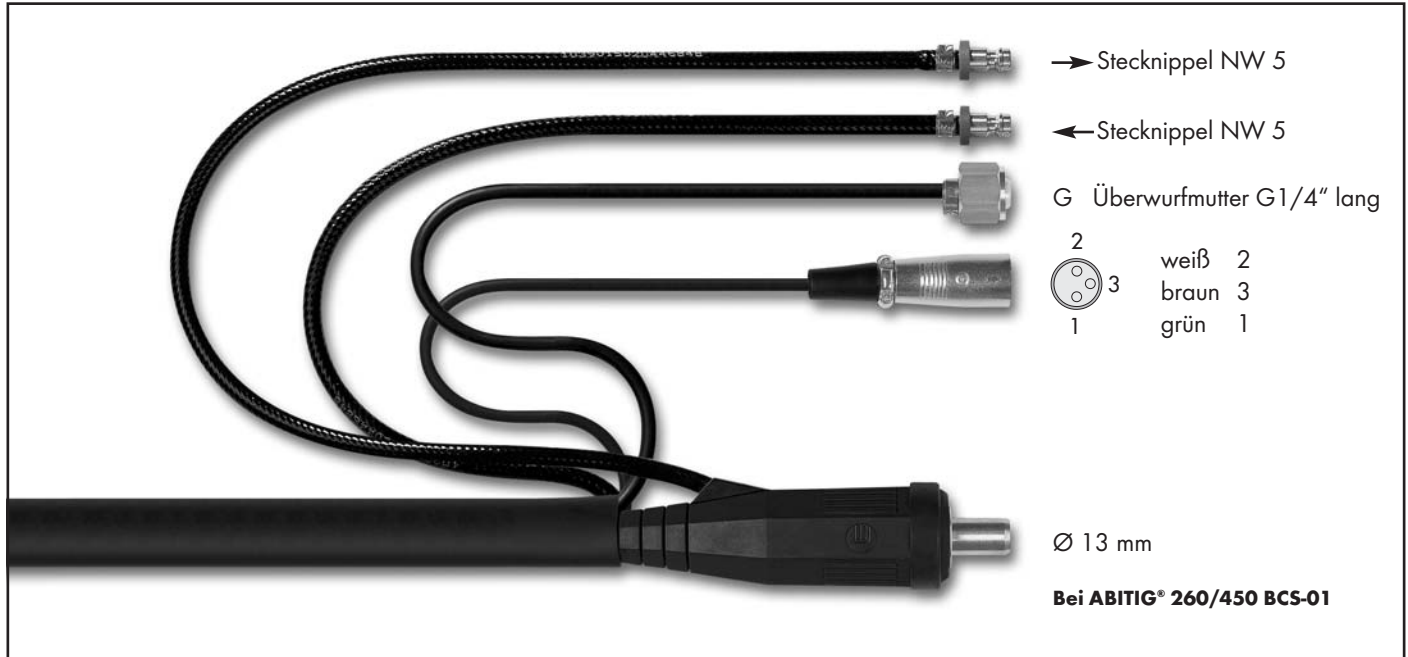

Brennertyp	Länge	Schalterfunktion	maschinenseitiger Anschluss	Schlauchpaketausführung	Bestellnummer
ABITIG® 18	4 m	DD	BSB 35-50 Rundsteckverb. 3-pol.	Standard	7S4SK043020041A81
	8 m	DD	BSB 35-50 Rundsteckverb. 3-pol.	Standard	7S4SK083020041A81
	4 m	DD	BSB 35-50 Rundsteckverb. 3-pol.	High Flex Leder	7S4SH043020041A81
	8 m	DD	BSB 35-50 Rundsteckverb. 3-pol.	High Flex Leder	7S4SH083020041A81
ABITIG® 18F	4 m	DD	BSB 35-50 Rundsteckverb. 3-pol.	Standard	7S4FK043020041A81
	8 m	DD	BSB 35-50 Rundsteckverb. 3-pol.	Standard	7S4FK083020041A81
	4 m	DD	BSB 35-50 Rundsteckverb. 3-pol.	High Flex Leder	7S4FH043020041A81
	8 m	DD	BSB 35-50 Rundsteckverb. 3-pol.	High Flex Leder	7S4FH083020041A81
ABITIG® 20	4 m	DD	BSB 35-50 Rundsteckverb. 3-pol.	Standard	7S5SK043020041A81
	8 m	DD	BSB 35-50 Rundsteckverb. 3-pol.	Standard	7S5SK083020041A81
	4 m	DD	BSB 35-50 Rundsteckverb. 3-pol.	High Flex Leder	7S5SH043020041A81
	8 m	DD	BSB 35-50 Rundsteckverb. 3-pol.	High Flex Leder	7S5SH083020041A81
ABITIG® 20F	4 m	DD	BSB 35-50 Rundsteckverb. 3-pol.	Standard	7S5FK043020041A81
	8 m	DD	BSB 35-50 Rundsteckverb. 3-pol.	Standard	7S5FK083020041A81
	4 m	DD	BSB 35-50 Rundsteckverb. 3-pol.	High Flex Leder	7S5FH043020041A81
	8 m	DD	BSB 35-50 Rundsteckverb. 3-pol.	High Flex Leder	7S5FH083020041A81

Technische Änderungen vorbehalten • Verkaufspreise = unverbindliche Preisempfehlung - Angebot freibleibend • © Copyright

ABITIG®-Brennerpreisliste

passend für WIG-Stromquellen des Fabrikates „weltec“

Brennertyp	Länge	Schalterfunktion	maschinenseitiger Anschluss	Schlauchpaketausführung	Bestellnummer
ABITIG® 12-1	4 m	DD	BSB 35-50 Rundsteckverb. 3-pol.	Standard	7S6SK043020041A81
	8 m	DD	BSB 35-50 Rundsteckverb. 3-pol.	Standard	7S6SK083020041A81
	4 m	DD	BSB 35-50 Rundsteckverb. 3-pol.	High Flex Leder	7S6SH043020041A81
	8 m	DD	BSB 35-50 Rundsteckverb. 3-pol.	High Flex Leder	7S6SH083020041A81
ABITIG® 18SC	4 m	DD	BSB 35-50 Rundsteckverb. 3-pol.	Standard	7S7SK043020041A81
	8 m	DD	BSB 35-50 Rundsteckverb. 3-pol.	Standard	7S7SK083020041A81
	4 m	DD	BSB 35-50 Rundsteckverb. 3-pol.	High Flex Leder	7S7SH043020041A81
	8 m	DD	BSB 35-50 Rundsteckverb. 3-pol.	High Flex Leder	7S7SH083020041A81
ABITIG® 24W	4 m	DD	BSB 35-50 Rundsteckverb. 3-pol.	Standard	7S9SK043020041A81
	8 m	DD	BSB 35-50 Rundsteckverb. 3-pol.	Standard	7S9SK083020041A81
	4 m	DD	BSB 35-50 Rundsteckverb. 3-pol.	High Flex Leder	7S9SH043020041A81
	8 m	DD	BSB 35-50 Rundsteckverb. 3-pol.	High Flex Leder	7S9SH083020041A81
ABITIG® 450W	4 m	DD	BSB 35-50 Rundsteckverb. 3-pol.	Standard	7T5SK043020141A81
	8 m	DD	BSB 35-50 Rundsteckverb. 3-pol.	Standard	7T5SK083020141A81
	4 m	DD	BSB 35-50 Rundsteckverb. 3-pol.	High Flex Leder	7T5SH043020141A81
	8 m	DD	BSB 35-50 Rundsteckverb. 3-pol.	High Flex Leder	7T5SH083020141A81
ABITIG® 260W	4 m	DD	BSB 35-50 Rundsteckverb. 3-pol.	Standard	7T7SK043020141A81
	8 m	DD	BSB 35-50 Rundsteckverb. 3-pol.	Standard	7T7SK083020141A81
	4 m	DD	BSB 35-50 Rundsteckverb. 3-pol.	High Flex Leder	7T7SH043020141A81
	8 m	DD	BSB 35-50 Rundsteckverb. 3-pol.	High Flex Leder	7T7SH083020141A81
ABITIG® 450W SC	4 m	DD	BSB 35-50 Rundsteckverb. 3-pol.	Standard	
	8 m	DD	BSB 35-50 Rundsteckverb. 3-pol.	Standard	
	4 m	DD	BSB 35-50 Rundsteckverb. 3-pol.	High Flex Leder	7T8SH043020141A81
	8 m	DD	BSB 35-50 Rundsteckverb. 3-pol.	High Flex Leder	7T8SH083020141A81

ABITIG®-Brennerpreisliste

passend für WIG-Stromquellen des Fabrikates „woltersdorf“



Stecknippel NW 5

offen

Ø 13 mm

Brennertyp	Länge	Schalterfunktion	maschinenseitiger Anschluss	Schlauchpaketausführung	Bestellnummer
ABITIG® 9	4 m	DD	BSB 35-50 offen	Standard	7S1SK043020000006
	8 m	DD	BSB 35-50 offen	Standard	7S1SK083020000006
	4 m	DD	BSB 35-50 offen	High Flex Leder	7S1SH043020000006
	8 m	DD	BSB 35-50 offen	High Flex Leder	7S1SH083020000006
ABITIG® 9F	4 m	DD	BSB 35-50 offen	Standard	7S1FK043020000006
	8 m	DD	BSB 35-50 offen	Standard	7S1FK083020000006
	4 m	DD	BSB 35-50 offen	High Flex Leder	7S1FH043020000006
	8 m	DD	BSB 35-50 offen	High Flex Leder	7S1FH083020000006
ABITIG® 17	4 m	DD	BSB 35-50 offen	Standard	7S2SK043020000006
	8 m	DD	BSB 35-50 offen	Standard	7S2SK083020000006
	4 m	DD	BSB 35-50 offen	High Flex Leder	7S2SH043020000006
	8 m	DD	BSB 35-50 offen	High Flex Leder	7S2SH083020000006
ABITIG® 17F	4 m	DD	BSB 35-50 offen	Standard	7S2FK043020000006
	8 m	DD	BSB 35-50 offen	Standard	7S2FK083020000006
	4 m	DD	BSB 35-50 offen	High Flex Leder	7S2FH043020000006
	8 m	DD	BSB 35-50 offen	High Flex Leder	7S2FH083020000006

Technische Änderungen vorbehalten • Verkaufspreise = unverbindliche Preisempfehlung - Angebot freibleibend • © Copyright

ABITIG®-Brennerpreisliste

passend für WIG-Stromquellen des Fabrikates „woltersdorf“

Brennertyp	Länge	Schalterfunktion	maschinenseitiger Anschluss	Schlauchpaketausführung	Bestellnummer
ABITIG® 26	4 m	DD	BSB 35-50 offen	Standard	7S3SK043020000006
	8 m	DD	BSB 35-50 offen	Standard	7S3SK083020000006
	4 m	DD	BSB 35-50 offen	High Flex Leder	7S3SH043020000006
	8 m	DD	BSB 35-50 offen	High Flex Leder	7S3SH083020000006
ABITIG® 26F	4 m	DD	BSB 35-50 offen	Standard	7S3FK043020000006
	8 m	DD	BSB 35-50 offen	Standard	7S3FK083020000006
	4 m	DD	BSB 35-50 offen	High Flex Leder	7S3FH043020000006
	8 m	DD	BSB 35-50 offen	High Flex Leder	7S3FH083020000006
ABITIG® 24G	4 m	DD	BSB 35-50 offen	Standard	7S8SK043020000006
	8 m	DD	BSB 35-50 offen	Standard	7S8SK083020000006
	4 m	DD	BSB 35-50 offen	High Flex Leder	7S8SH043020000006
	8 m	DD	BSB 35-50 offen	High Flex Leder	7S8SH083020000006
ABITIG® 200	4 m	DD	BSB 35-50 offen	Standard	7T4SK043020000006
	8 m	DD	BSB 35-50 offen	Standard	7T4SK083020000006
	4 m	DD	BSB 35-50 offen	High Flex Leder	7T4SH043020000006
	8 m	DD	BSB 35-50 offen	High Flex Leder	7T4SH083020000006
ABITIG® 200F	4 m	DD	BSB 35-50 offen	Standard	7T4FK043020000006
	8 m	DD	BSB 35-50 offen	Standard	7T4FK083020000006
	4 m	DD	BSB 35-50 offen	High Flex Leder	7T4FH043020000006
	8 m	DD	BSB 35-50 offen	High Flex Leder	7T4FH083020000006
ABITIG® 150	4 m	DD	BSB 35-50 offen	Standard	7T6SK043020000006
	8 m	DD	BSB 35-50 offen	Standard	7T6SK083020000006
	4 m	DD	BSB 35-50 offen	High Flex Leder	7T6SH043020000006
	8 m	DD	BSB 35-50 offen	High Flex Leder	7T6SH083020000006
ABITIG® 150F	4 m	DD	BSB 35-50 offen	Standard	7T6FK043020000006
	8 m	DD	BSB 35-50 offen	Standard	7T6FK083020000006
	4 m	DD	BSB 35-50 offen	High Flex Leder	7T6FH043020000006
	8 m	DD	BSB 35-50 offen	High Flex Leder	7T6FH083020000006

ABITIG®-Brennerpreisliste

passend für WIG-Stromquellen des Fabrikates „woltersdorf“

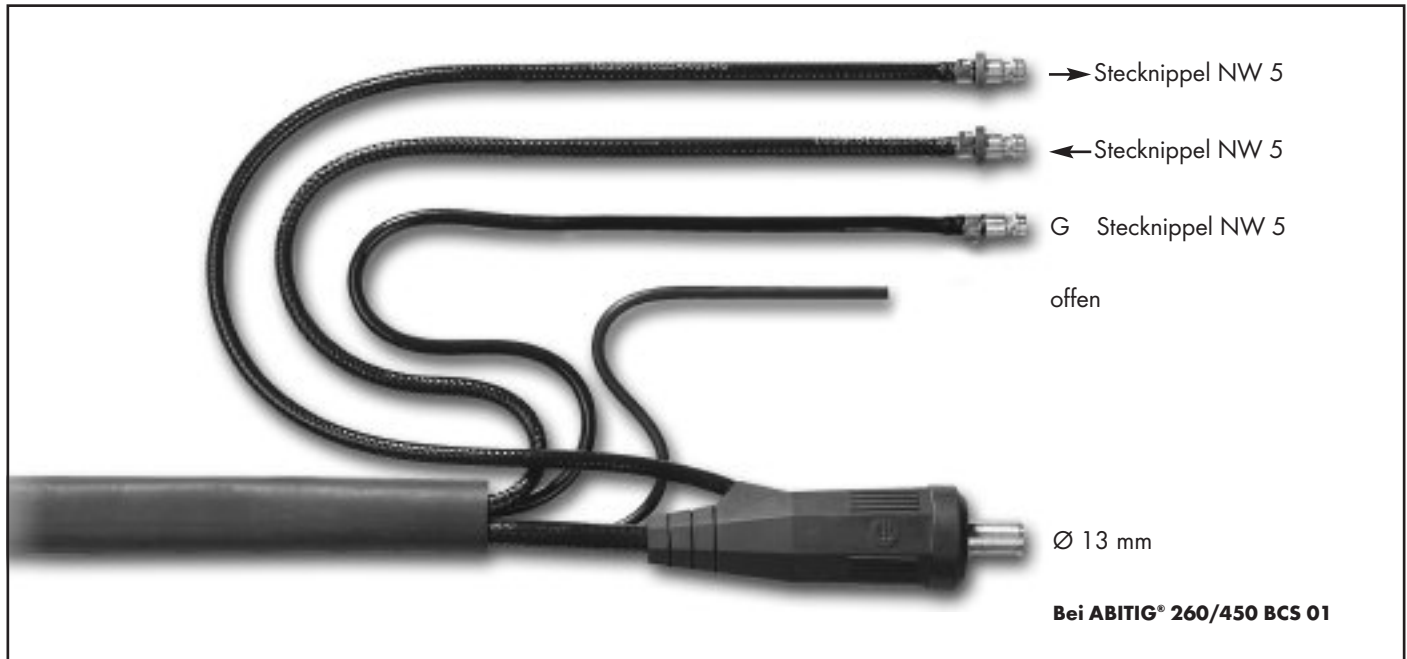

Brennertyp	Länge	Schalterfunktion	maschinenseitiger Anschluss	Schlauchpaketausführung	Bestellnummer
ABITIG®	4 m	DD	BSB 35-50 offen	Standard	7S4SK043020000020
	8 m	DD	BSB 35-50 offen	Standard	7S4SK083020000020
	4 m	DD	BSB 35-50 offen	High Flex Leder	7S4SH043020000020
	8 m	DD	BSB 35-50 offen	High Flex Leder	7S4SH083020000020
ABITIG® F	4 m	DD	BSB 35-50 offen	Standard	7S4FK043020000020
	8 m	DD	BSB 35-50 offen	Standard	7S4FK083020000020
	4 m	DD	BSB 35-50 offen	High Flex Leder	7S4FH043020000020
	8 m	DD	BSB 35-50 offen	High Flex Leder	7S4FH083020000020
ABITIG® 20	4 m	DD	BSB 35-50 offen	Standard	7S5SK043020000020
	8 m	DD	BSB 35-50 offen	Standard	7S5SK083020000020
	4 m	DD	BSB 35-50 offen	High Flex Leder	7S5SH043020000020
	8 m	DD	BSB 35-50 offen	High Flex Leder	7S5SH083020000020
ABITIG® 20F	4 m	DD	BSB 35-50 offen	Standard	7S5FK043020000020
	8 m	DD	BSB 35-50 offen	Standard	7S5FK083020000020
	4 m	DD	BSB 35-50 offen	High Flex Leder	7S5FH043020000020
	8 m	DD	BSB 35-50 offen	High Flex Leder	7S5FH083020000020

Technische Änderungen vorbehalten • Verkaufspreise = unverbindliche Preisempfehlung - Angebot freibleibend • © Copyright

ABITIG®-Brennerpreisliste

passend für WIG-Stromquellen des Fabrikates „woltersdorf“

Brennertyp	Länge	Schalterfunktion	maschinenseitiger Anschluss	Schlauchpaketausführung	Bestellnummer
ABITIG® 12-1	4 m	DD	BSB 35-50 offen	Standard	7S6SK043020000020
	8 m	DD	BSB 35-50 offen	Standard	7S6SK083020000020
	4 m	DD	BSB 35-50 offen	High Flex Leder	7S6SH043020000020
	8 m	DD	BSB 35-50 offen	High Flex Leder	7S6SH083020000020
ABITIG® SC	4 m	DD	BSB 35-50 offen	Standard	7S7SK043020000020
	8 m	DD	BSB 35-50 offen	Standard	7S7SK083020000020
	4 m	DD	BSB 35-50 offen	High Flex Leder	7S7SH043020000020
	8 m	DD	BSB 35-50 offen	High Flex Leder	7S7SH083020000020
ABITIG® 24W	4 m	DD	BSB 35-50 offen	Standard	7S9SK043020000020
	8 m	DD	BSB 35-50 offen	Standard	7S9SK083020000020
	4 m	DD	BSB 35-50 offen	High Flex Leder	7S9SH043020000020
	8 m	DD	BSB 35-50 offen	High Flex Leder	7S9SH083020000020
ABITIG® 450W	4 m	DD	BSB 35-50 offen	Standard	7T5SK043020100020
	8 m	DD	BSB 35-50 offen	Standard	7T5SK083020100020
	4 m	DD	BSB 35-50 offen	High Flex Leder	7T5SH043020100020
	8 m	DD	BSB 35-50 offen	High Flex Leder	7T5SH083020100020
ABITIG® 260W	4 m	DD	BSB 35-50 offen	Standard	7T7SK043020100020
	8 m	DD	BSB 35-50 offen	Standard	7T7SK083020100020
	4 m	DD	BSB 35-50 offen	High Flex Leder	7T7SH043020100020
	8 m	DD	BSB 35-50 offen	High Flex Leder	7T7SH083020100020
ABITIG® 450W SC	4 m	DD	BSB 35-50 offen	Standard	
	8 m	DD	BSB 35-50 offen	Standard	
	4 m	DD	BSB 35-50 offen	High Flex Leder	7T8SH043020100020
	8 m	DD	BSB 35-50 offen	High Flex Leder	7T8SH083020100020

ABITIG®-Brennerpreisliste für MT Brenner (Automatenbrenner)

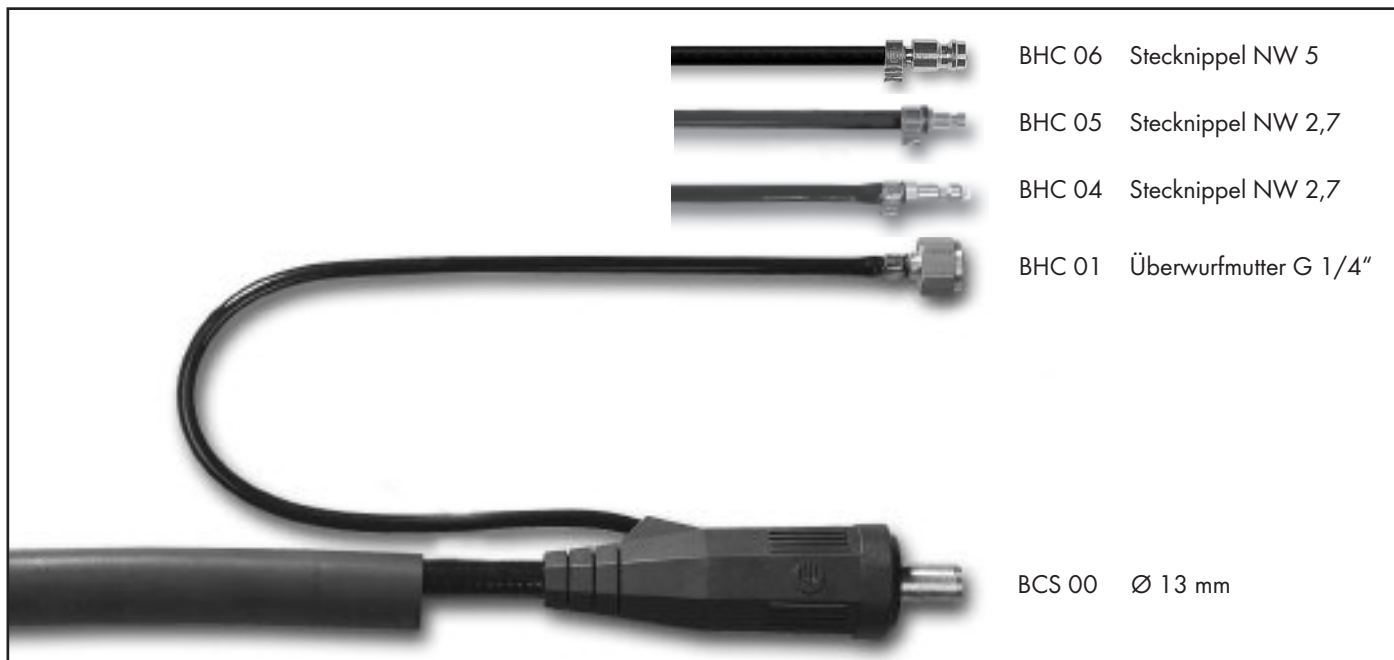

Brennertyp	Länge	maschinenseitiger Anschluss	Bestellnummer
ABITIG® 150 MT	4 m	BSB 3550 / G 1/4"	7M410400- -00- - -01
	8 m	BSB 3550 / G 1/4"	7M410800- -00- - -01
ABITIG® 200 MT*	4 m	BSB 3550 / G 1/4"	7M4V0400- -00- - -01
	8 m	BSB 3550 / G 1/4"	7M4V0800- -00- - -01
ABITIG® 150 MT	4 m	BSB 3550 / NW 2,7 Migatron	7M410400- -00- - -04
	8 m	BSB 3550 / NW 2,7 Migatron	7M410800- -00- - -04
ABITIG® 200 MT*	4 m	BSB 3550 / NW 2,7 Migatron	7M4V0400- -00- - -04
	8 m	BSB 3550 / NW 2,7 Migatron	7M4V0800- -00- - -04
ABITIG® 150 MT	4 m	BSB 3550 / NW 2,7	7M410400- -00- - -05
	8 m	BSB 3550 / NW 2,7	7M410800- -00- - -05
ABITIG® 200 MT*	4 m	BSB 3550 / NW 2,7	7M4V0400- -00- - -05
	8 m	BSB 3550 / NW 2,7	7M4V0800- -00- - -05
ABITIG® 150 MT	4 m	BSB 3550 / NW 5	7M410400- -00- - -06
	8 m	BSB 3550 / NW 5	7M410800- -00- - -06
ABITIG® 200 MT*	4 m	BSB 3550 / NW 5	7M4V0400- -00- - -06
	8 m	BSB 3550 / NW 5	7M4V0800- -00- - -06

Technische Änderungen vorbehalten • Verkaufspreise = unverbindliche Preisempfehlung - Angebot freibleibend • © Copyright
* Abitig 200 MT mit voreinstellbarer Elektrode

ABITIG®-Brennerpreisliste für MT Brenner (Automatenbrenner)



Brennertyp	Länge	maschinenseitiger Anschluss	Bestellnummer
ABITIG® 150 MT	4 m	ZA - GZ	7M410400- -03- - -00
	8 m	ZA - GZ	7M410800- -03- - -00
ABITIG® 200 MT*	4 m	ZA - GZ	7M4V0400- -03- - -00
	8 m	ZA - GZ	7M4V0800- -03- - -00

Technische Änderungen vorbehalten • Verkaufspreise = unverbindliche Preisempfehlung - Angebot freibleibend • © Copyright
* Abitig 200 MT mit voreinstellbarer Elektrode

ABITIG®-Brennerpreisliste für MT Brenner (Automatenbrenner)



Brennertyp	Länge	maschinenseitiger Anschluss	Bestellnummer
ABITIG® 150 MT	4 m	ZA WTG 5	7M410400- -04- - -00
	8 m	ZA WTG 5	7M410800- -04- - -00
ABITIG® 200 MT*	4 m	ZA WTG 5	7M4V0400- -04- - -00
	8 m	ZA WTG 5	7M4V0800- -04- - -00

Technische Änderungen vorbehalten • Verkaufspreise = unverbindliche Preisempfehlung – Angebot freibleibend • © Copyright
* Abitig 200 MT mit voreinstellbarer Elektrode

ABITIG®-Brennerpreisliste für MT Brenner (Automatenbrenner)



Brennertyp	Länge	maschinenseitiger Anschluss	Bestellnummer
ABITIG® 150 MT	4 m	G 3/8" Üwm.	7M410400- -06- - -00
	8 m	G 3/8" Üwm.	7M410800- -06- - -00
ABITIG® 200 MT*	4 m	G 3/8" Üwm.	7M4V0400- -06- - -00
	8 m	G 3/8" Üwm.	7M4V0800- -06- - -00

ABITIG®-Brennerpreisliste für MT Brenner (Automatenbrenner)



Brennertyp	Länge	maschinenseitiger Anschluss	Bestellnummer
ABITIG® 150 MT	4 m	ZA 9-polig	7M410400- -07- - -00
	8 m	ZA 9-polig	7M410800- -07- - -00
ABITIG® 200 MT*	4 m	ZA 9-polig	7M4V0400- -07- - -00
	8 m	ZA 9-polig	7M4V0800- -07- - -00

Technische Änderungen vorbehalten • Verkaufspreise = unverbindliche Preisempfehlung – Angebot freibleibend • © Copyright
* Abitig 200 MT mit voreinstellbarer Elektrode

ABITIG®-Brennerpreisliste für MT Brenner (Automatenbrenner)



BCS 11 Überwurfmutter G 1/4"

Brennertyp	Länge	maschinenseitiger Anschluss	Bestellnummer
ABITIG® 150 MT	4 m	G 1/4" Üwm.	7M410400- -11- - -00
	8 m	G 1/4" Üwm.	7M410800- -11- - -00
ABITIG® 200 MT*	4 m	G 1/4" Üwm.	7M4V0400- -11- - -00
	8 m	G 1/4" Üwm.	7M4V0800- -11- - -00

Technische Änderungen vorbehalten • Verkaufspreise = unverbindliche Preisempfehlung - Angebot freibleibend • © Copyright
* Abitig 200 MT mit voreinstellbarer Elektrode

ABITIG®-Brennerpreisliste für MT Brenner (Automatenbrenner)



Brennertyp	Länge	maschinenseitiger Anschluss	Bestellnummer
ABITIG® 150 MT	4 m	oerlikon ZA	7M410400- -18- - -00
	8 m	oerlikon ZA	7M410800- -18- - -00
ABITIG® 200 MT*	4 m	oerlikon ZA	7M4V0400- -18- - -00
	8 m	oerlikon ZA	7M4V0800- -18- - -00

Technische Änderungen vorbehalten • Verkaufspreise = unverbindliche Preisempfehlung – Angebot freibleibend • © Copyright
* Abitig 200 MT mit voreinstellbarer Elektrode

ABITIG®-Brennerpreisliste für MT Brenner (Automatenbrenner)



Brennertyp	Länge	maschinenseitiger Anschluss	Bestellnummer
ABITIG® 150 MT	4 m	CG Anschluss dalex	7M410400- -20- - -00
	8 m	CG Anschluss dalex	7M410800- -20- - -00
ABITIG® 200 MT*	4 m	CG Anschluss dalex	7M4V0400- -20- - -00
	8 m	CG Anschluss dalex	7M4V0800- -20- - -00

ABITIG®-Brennerpreisliste für MT Brenner (Automatenbrenner)

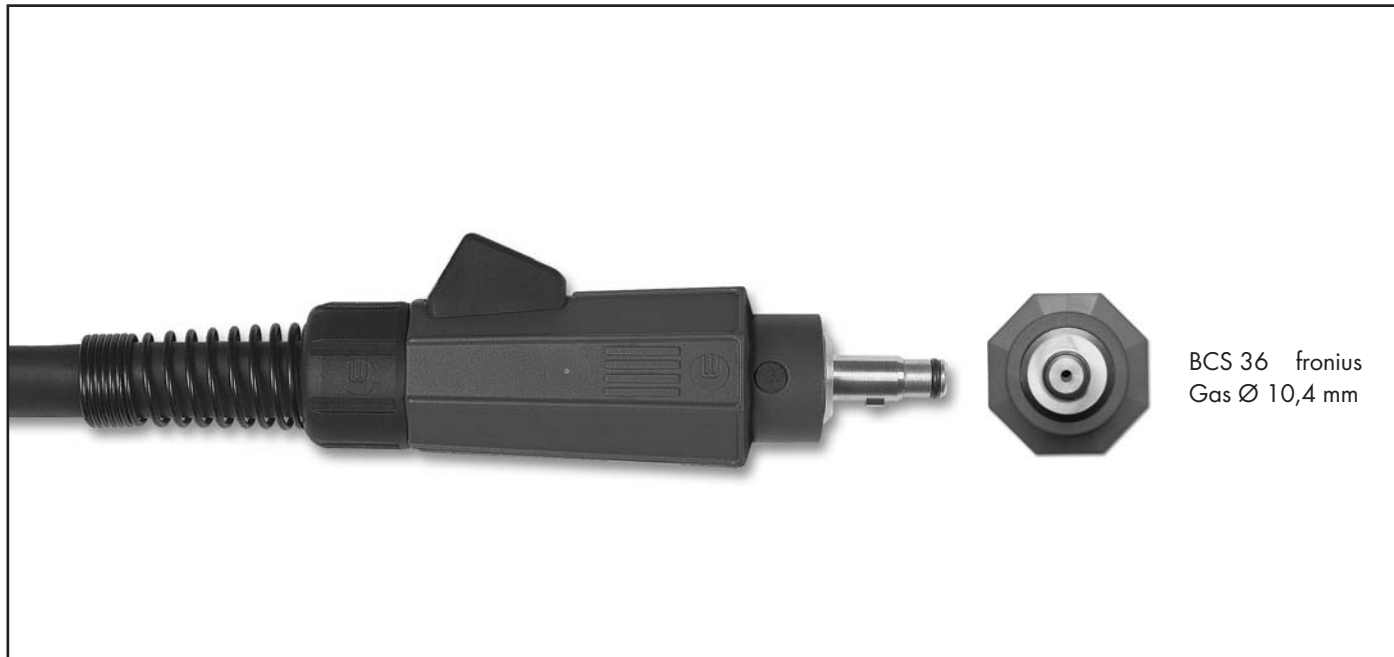

Brennertyp	Länge	maschinenseitiger Anschluss	Bestellnummer
ABITIG® 150 MT	4 m	TTG Anschluss Fronius	7M410400- -36- - -00
	8 m	TTG Anschluss Fronius	7M410800- -36- - -00
ABITIG® 200 MT*	4 m	TTG Anschluss Fronius	7M4V0400- -36- - -00
	8 m	TTG Anschluss Fronius	7M4V0800- -36- - -00

Technische Änderungen vorbehalten • Verkaufspreise = unverbindliche Preisempfehlung - Angebot freibleibend • © Copyright

* Abitig 200 MT mit voreinstellbarer Elektrode

ABITIG®-Brennerpreisliste für MT Brenner (Automatenbrenner)

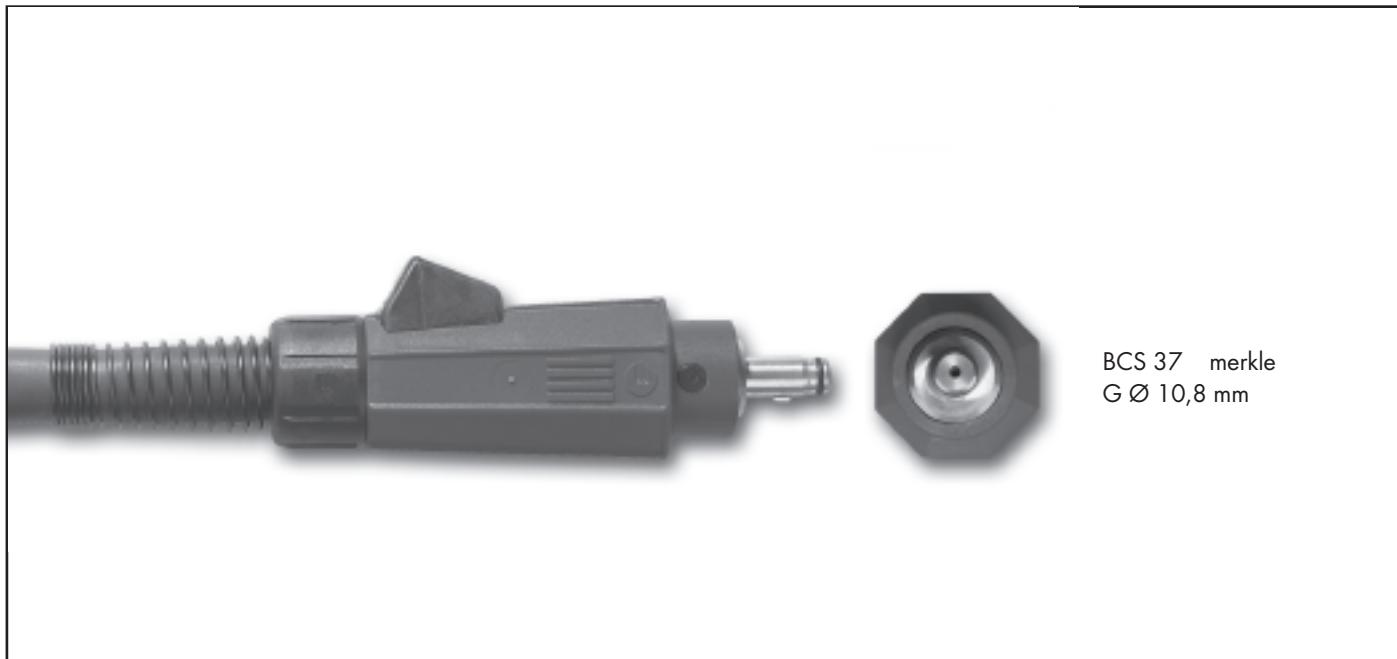

Brennertyp	Länge	maschinenseitiger Anschluss	Bestellnummer
ABITIG® 150 MT	4 m	TCG Anschluss merkle	7M410400- -37- - -00
	8 m	TCG Anschluss merkle	7M410800- -37- - -00
ABITIG® 200 MT*	4 m	TCG Anschluss merkle	7M4V0400- -37- - -00
	8 m	TCG Anschluss merkle	7M4V0800- -37- - -00

ABITIG®-Brennerpreisliste für MT Brenner (Automatenbrenner)

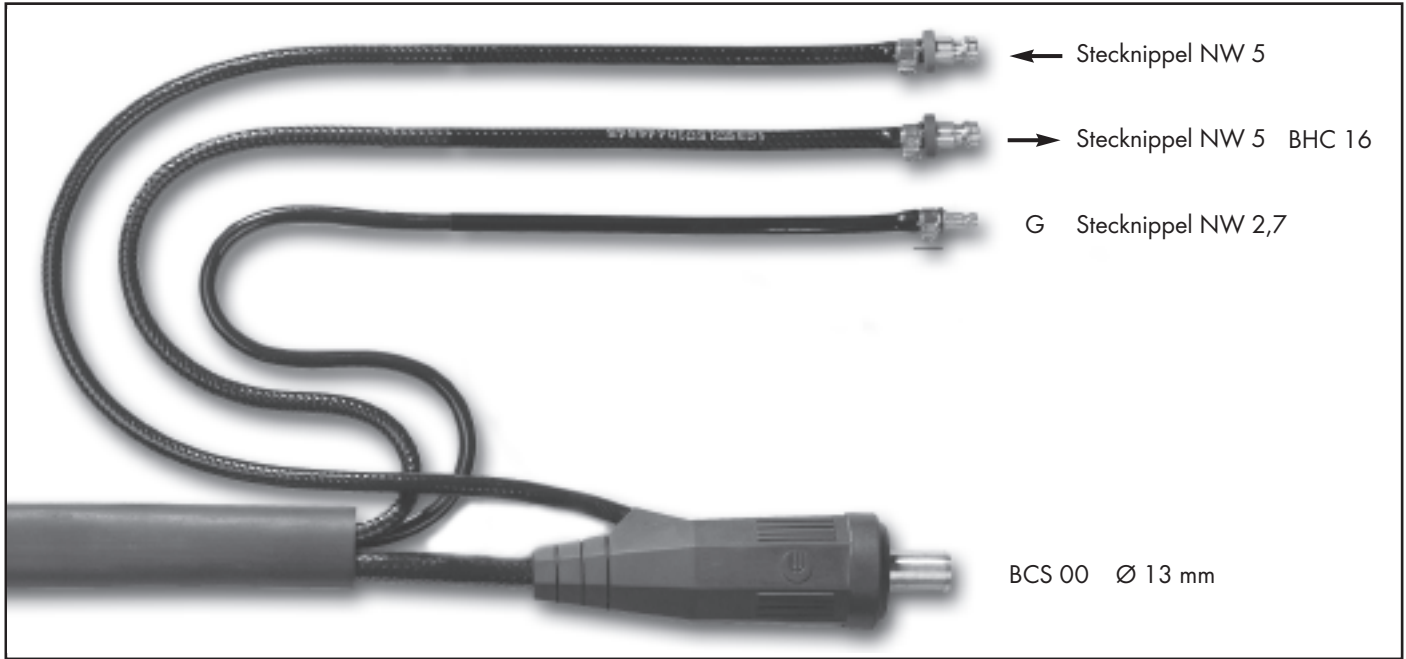

Brennertyp	Länge	maschinenseitiger Anschluss	Bestellnummer
ABITIG® 260 W MT	4 m	BSB 3550	7M510400- -00- - -16
	8 m	BSB 3550	7M510800- -00- - -16
ABITIG® 300 W MT*	4 m	BSB 3550	7M5V0400- -00- - -16
	8 m	BSB 3550	7M5V0800- -00- - -16
ABITIG® 400 W MT	4 m	BSB 3550	7M520400- -00- - -16
	8 m	BSB 3550	7M520800- -00- - -16
ABITIG® 500 W MT	4 m	BSB 3550	7M550400- -00- - -16
	8 m	BSB 3550	7M550800- -00- - -16

Technische Änderungen vorbehalten • Verkaufspreise = unverbindliche Preisempfehlung - Angebot freibleibend • © Copyright
* Abitig 300 mit voreinstellbarer Elektrode

ABITIG®-Brennerpreisliste für MT Brenner (Automatenbrenner)

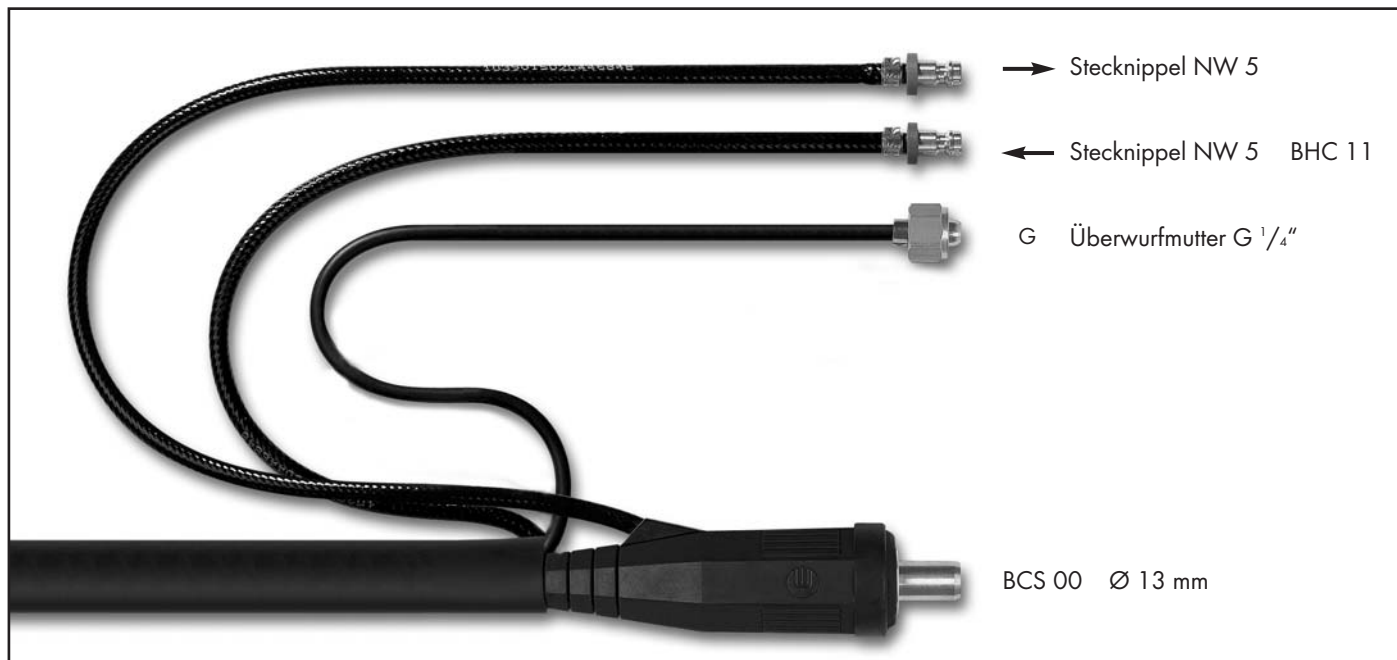

Brennertyp	Länge	maschinenseitiger Anschluss	Bestellnummer
ABITIG® 260 W MT	4 m	BSB 3550	7M510400- -00- - -11
	8 m	BSB 3550	7M510800- -00- - -11
ABITIG® 300 W MT*	4 m	BSB 3550	7M5V0400- -00- - -11
	8 m	BSB 3550	7M5V0800- -00- - -11
ABITIG® 400 W MT	4 m	BSB 3550	7M520400- -00- - -11
	8 m	BSB 3550	7M520800- -00- - -11
ABITIG® 500 W MT	4 m	BSB 3550	7M550400- -00- - -11
	8 m	BSB 3550	7M550800- -00- - -11

ABITIG®-Brennerpreisliste für MT Brenner (Automatenbrenner)

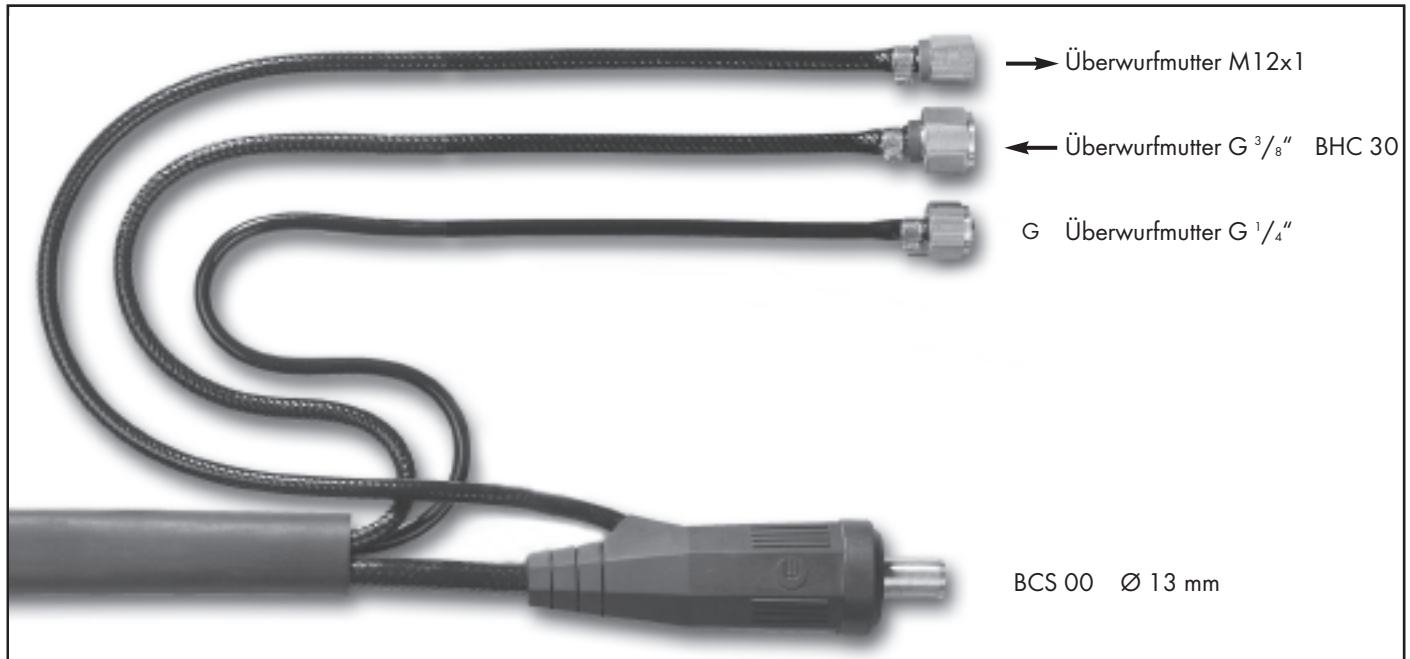

Brennertyp	Länge	maschinenseitiger Anschluss	Bestellnummer
ABITIG® 260 W MT	4 m	BSB 3550	7M510400- -00- - -30
	8 m	BSB 3550	7M510800- -00- - -30
ABITIG® 300 W MT*	4 m	BSB 3550	7M5V0400- -00- - -30
	8 m	BSB 3550	7M5V0800- -00- - -30
ABITIG® 400 W MT	4 m	BSB 3550	7M520400- -00- - -30
	8 m	BSB 3550	7M520800- -00- - -30
ABITIG® 500 W MT	4 m	BSB 3550	7M550400- -00- - -30
	8 m	BSB 3550	7M550800- -00- - -30

Technische Änderungen vorbehalten • Verkaufspreise = unverbindliche Preisempfehlung - Angebot freibleibend • © Copyright
* Abitig 300 mit voreinstellbarer Elektrode

ABITIG®-Brennerpreisliste für MT Brenner (Automatenbrenner)

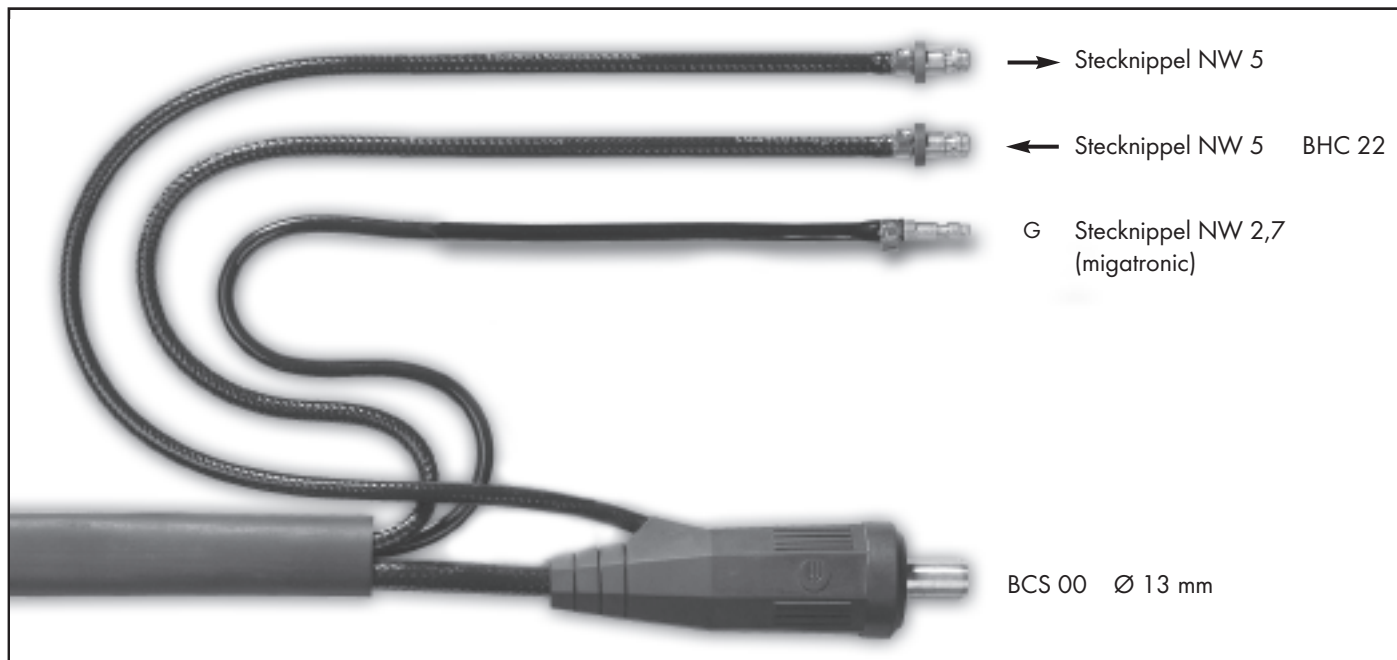

Brennertyp	Länge	maschinenseitiger Anschluss	Bestellnummer
ABITIG® 260 W MT	4 m	BSB 3550	7M510400- -00- - -22
	8 m	BSB 3550	7M510800- -00- - -22
ABITIG® 300 W MT*	4 m	BSB 3550	7M5V0400- -00- - -22
	8 m	BSB 3550	7M5V0800- -00- - -22
ABITIG® 400 W MT	4 m	BSB 3550	7M520400- -00- - -22
	8 m	BSB 3550	7M520800- -00- - -22
ABITIG® 500 W MT	4 m	BSB 3550	7M550400- -00- - -22
	8 m	BSB 3550	7M550800- -00- - -22

ABITIG®-Brennerpreisliste für MT Brenner (Automatenbrenner)

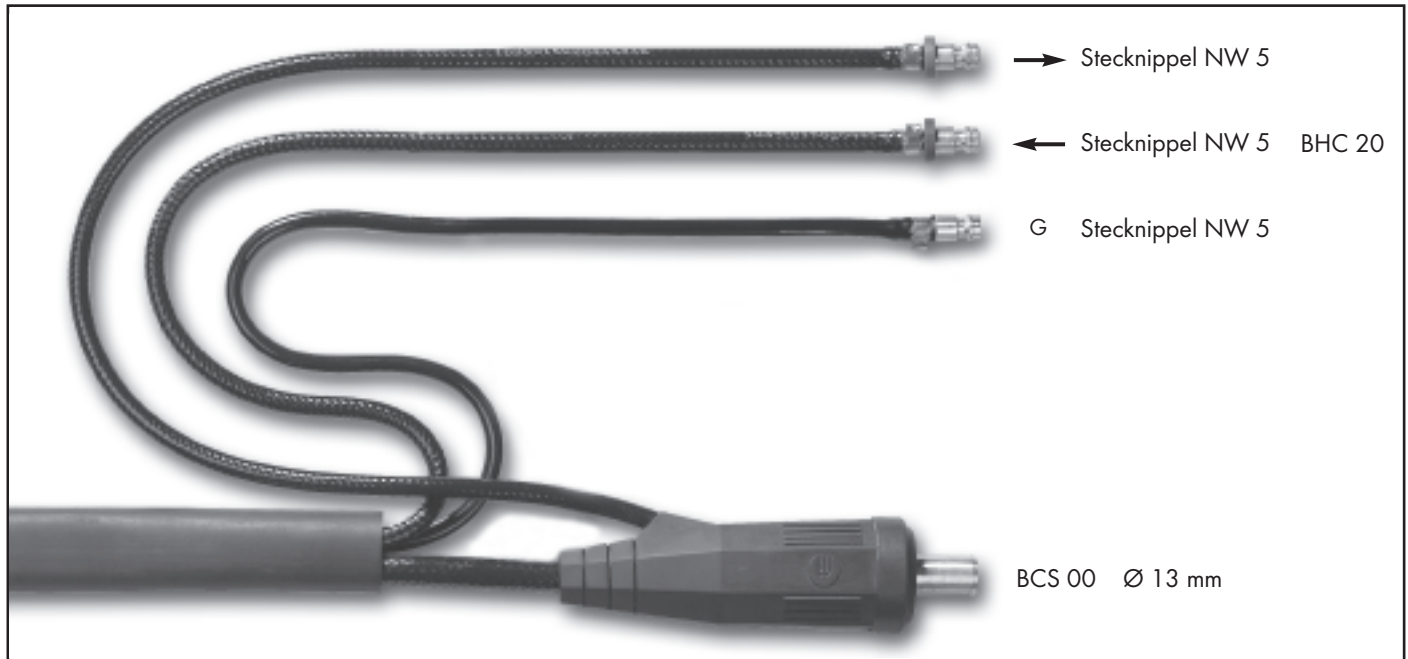

Brennertyp	Länge	maschinenseitiger Anschluss	Bestellnummer
ABITIG® 260 W MT	4 m	BSB 3550	7M510400- -00- - -20
	8 m	BSB 3550	7M510800- -00- - -20
ABITIG® 300 W MT*	4 m	BSB 3550	7M5V0400- -00- - -20
	8 m	BSB 3550	7M5V0800- -00- - -20
ABITIG® 400 W MT	4 m	BSB 3550	7M520400- -00- - -20
	8 m	BSB 3550	7M520800- -00- - -20
ABITIG® 500 W MT	4 m	BSB 3550	7M550400- -00- - -20
	8 m	BSB 3550	7M550800- -00- - -20

Technische Änderungen vorbehalten • Verkaufspreise = unverbindliche Preisempfehlung – Angebot freibleibend • © Copyright
* Abitig 300 mit voreinstellbarer Elektrode

ABITIG®-Brennerpreisliste für MT Brenner (Automatenbrenner)

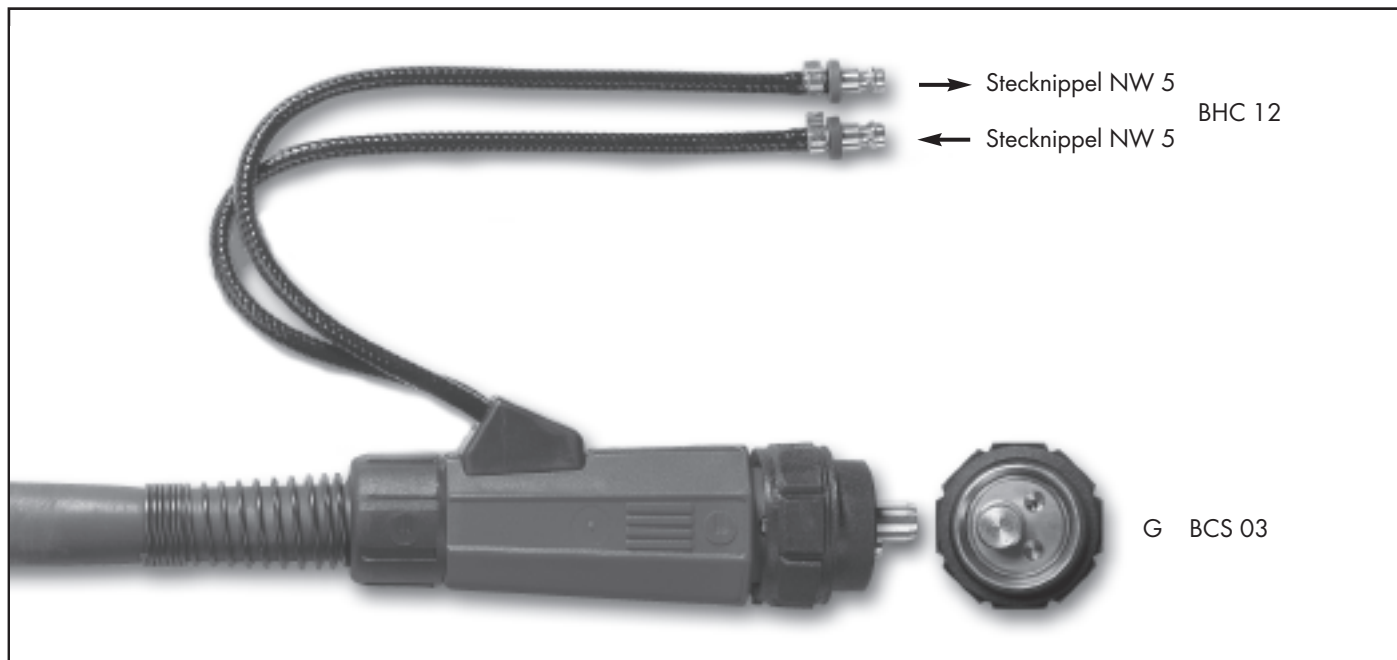

Brennertyp	Länge	maschinenseitiger Anschluss	Bestellnummer
ABITIG® 260 W MT	4 m	ZA WZ-0	7M510400- -03- - -12
	8 m	ZA WZ-0	7M510800- -03- - -12
ABITIG® 300 W MT*	4 m	ZA WZ-0	7M5V0400- -03- - -12
	8 m	ZA WZ-0	7M5V0800- -03- - -12
ABITIG® 400 W MT	4 m	ZA WZ-0	7M520400- -03- - -12
	8 m	ZA WZ-0	7M520800- -03- - -12
ABITIG® 500 W MT	4 m	ZA WZ-0	7M550400- -03- - -12
	8 m	ZA WZ-0	7M550800- -03- - -12

Technische Änderungen vorbehalten • Verkaufspreise = unverbindliche Preisempfehlung - Angebot freibleibend • © Copyright
* Abitig 300 mit voreinstellbarer Elektrode

ABITIG®-Brennerpreisliste für MT Brenner (Automatenbrenner)

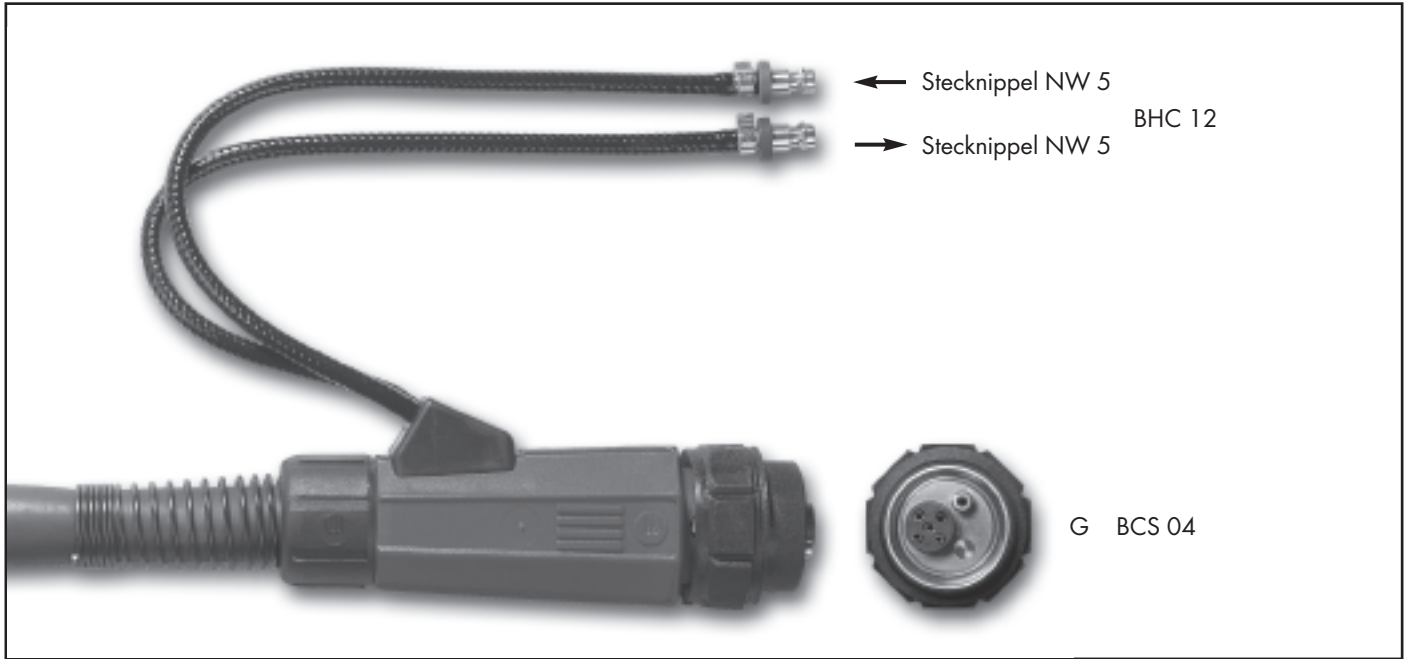

Brennertyp	Länge	maschinenseitiger Anschluss	Bestellnummer
ABITIG® 260 W MT	4 m	ZA WTW 5	7M510400- -04- - -12
	8 m	ZA WTW 5	7M510800- -04- - -12
ABITIG® 300 W MT*	4 m	ZA WTW 5	7M5V0400- -04- - -12
	8 m	ZA WTW 5	7M5V0800- -04- - -12
ABITIG® 400 W MT	4 m	ZA WTW 5	7M520400- -04- - -12
	8 m	ZA WTW 5	7M520800- -04- - -12
ABITIG® 500 W MT	4 m	ZA WTW 5	7M550400- -04- - -12
	8 m	ZA WTW 5	7M550800- -04- - -12

Technische Änderungen vorbehalten • Verkaufspreise = unverbindliche Preisempfehlung – Angebot freibleibend • © Copyright
* Abitig 300 mit voreinstellbarer Elektrode

ABITIG®-Brennerpreisliste für MT Brenner (Automatenbrenner)

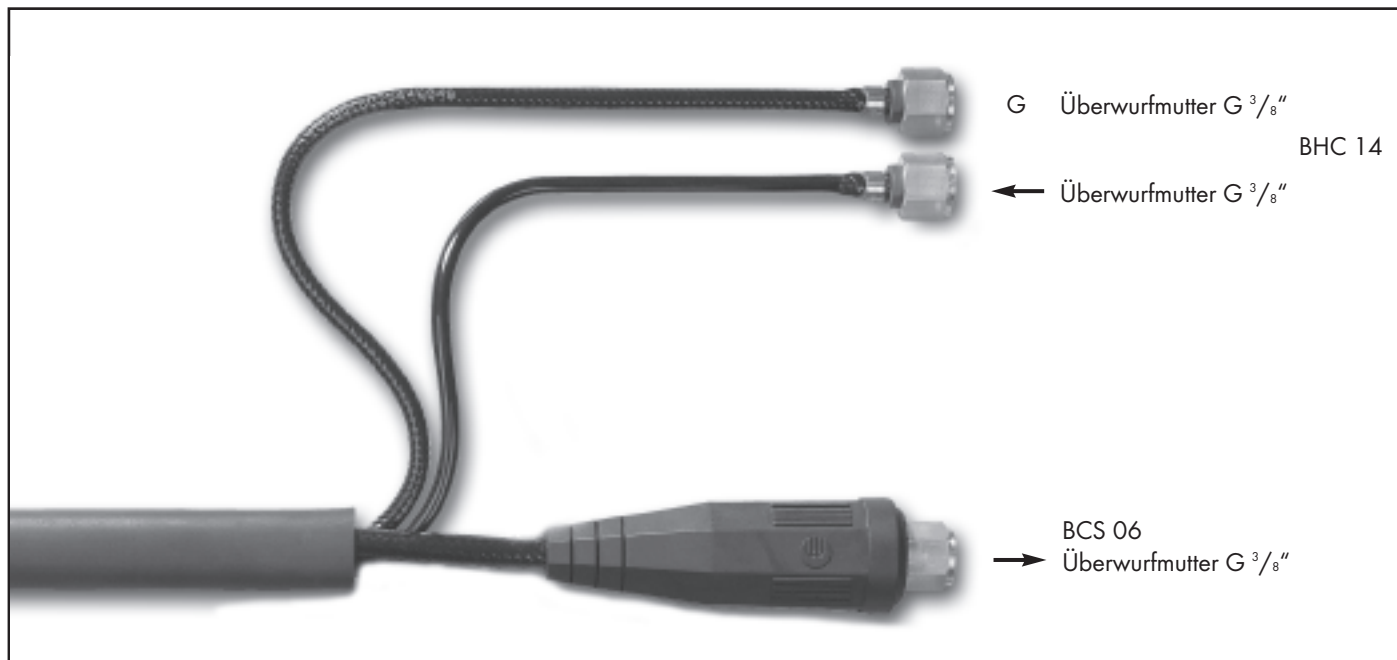

Brennertyp	Länge	maschinenseitiger Anschluss	Bestellnummer
ABITIG® 260 W MT	4 m	EA	7M510400- -06- - -14
	8 m	EA	7M510800- -06- - -14
ABITIG® 300 W MT*	4 m	EA	7M5V0400- -06- - -14
	8 m	EA	7M5V0800- -06- - -14
ABITIG® 400 W MT	4 m	EA	7M520400- -06- - -14
	8 m	EA	7M520800- -06- - -14
ABITIG® 500 W MT	4 m	EA	7M550400- -06- - -14
	8 m	EA	7M550800- -06- - -14

ABITIG®-Brennerpreisliste für MT Brenner (Automatenbrenner)

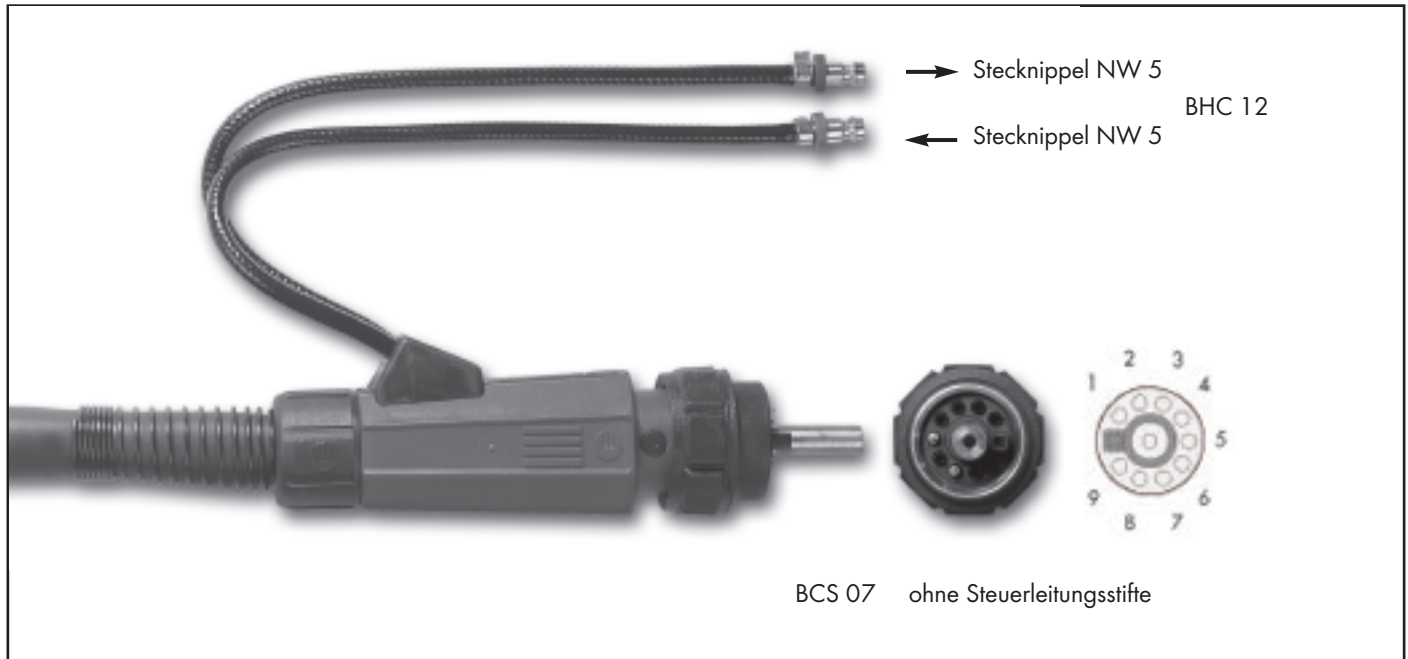

Brennertyp	Länge	maschinenseitiger Anschluss	Bestellnummer
ABITIG® 260 W MT	4 m	ZA 9-polig	7M510400- -07- - -12
	8 m	ZA 9-polig	7M510800- -07- - -12
ABITIG® 300 W MT*	4 m	ZA 9-polig	7M5V0400- -07- - -12
	8 m	ZA 9-polig	7M5V0800- -07- - -12
ABITIG® 400 W MT	4 m	ZA 9-polig	7M520400- -07- - -12
	8 m	ZA 9-polig	7M520800- -07- - -12
ABITIG® 500 W MT	4 m	ZA 9-polig	7M550400- -07- - -12
	8 m	ZA 9-polig	7M550800- -07- - -12

Technische Änderungen vorbehalten • Verkaufspreise = unverbindliche Preisempfehlung – Angebot freibleibend • © Copyright
* Abitig 300 mit voreinstellbarer Elektrode

ABITIG®-Brennerpreisliste für MT Brenner (Automatenbrenner)

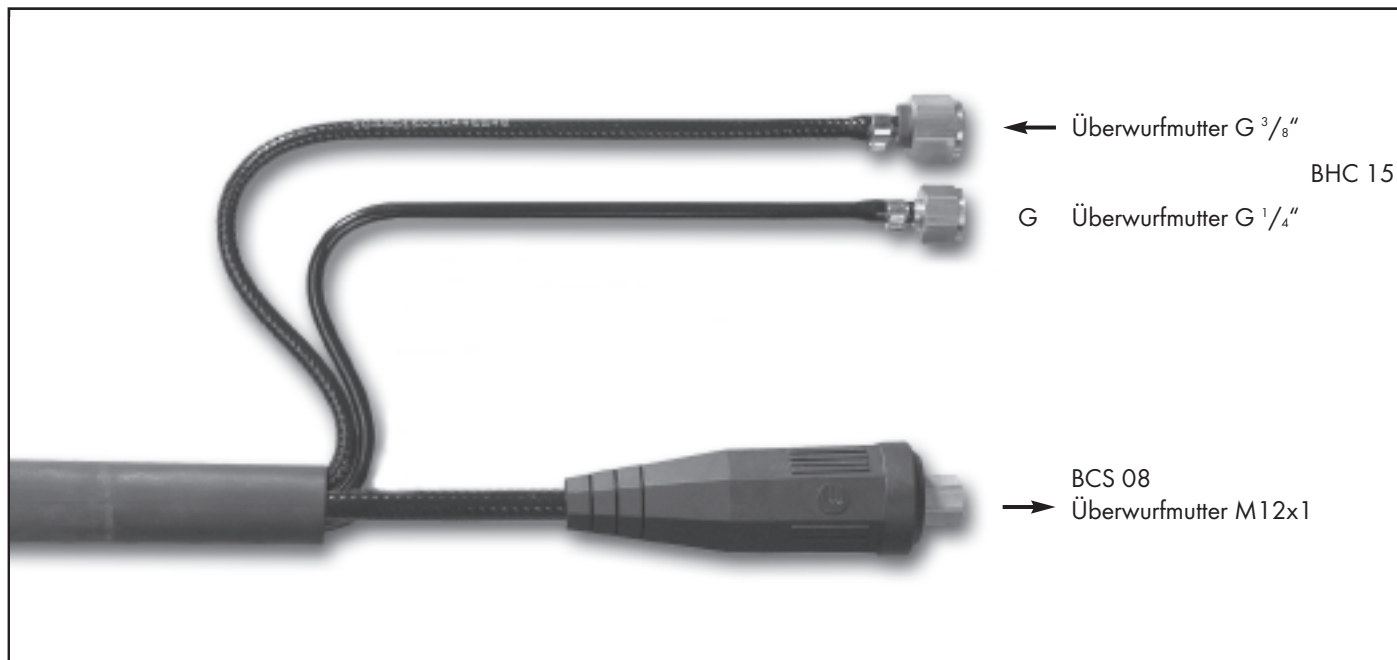

Brennertyp	Länge	maschinenseitiger Anschluss	Bestellnummer
ABITIG® 260 W MT	4 m	EA	7M510400- -08- - -15
	8 m	EA	7M510800- -08- - -15
ABITIG® 300 W MT*	4 m	EA	7M5V0400- -08- - -15
	8 m	EA	7M5V0800- -08- - -15
ABITIG® 400 W MT	4 m	EA	7M520400- -08- - -15
	8 m	EA	7M520800- -08- - -15
ABITIG® 500 W MT	4 m	EA	7M550400- -08- - -15
	8 m	EA	7M550800- -08- - -15

ABITIG®-Brennerpreisliste für MT Brenner (Automatenbrenner)



Brennertyp	Länge	maschinenseitiger Anschluss	Bestellnummer
ABITIG® 260 W MT	4 m	oerlikon ZA	7M510400- -19- - -00
	8 m	oerlikon ZA	7M510800- -19- - -00
ABITIG® 300 W MT*	4 m	oerlikon ZA	7M5V0400- -19- - -00
	8 m	oerlikon ZA	7M5V0800- -19- - -00
ABITIG® 400 W MT	4 m	oerlikon ZA	7M520400- -19- - -00
	8 m	oerlikon ZA	7M520800- -19- - -00
ABITIG® 500 W MT	4 m	oerlikon ZA	7M550400- -19- - -00
	8 m	oerlikon ZA	7M550800- -19- - -00

Technische Änderungen vorbehalten • Verkaufspreise = unverbindliche Preisempfehlung – Angebot freibleibend • © Copyright
* Abitig 300 mit voreinstellbarer Elektrode

ABITIG®-Brennerpreisliste für MT Brenner (Automatenbrenner)

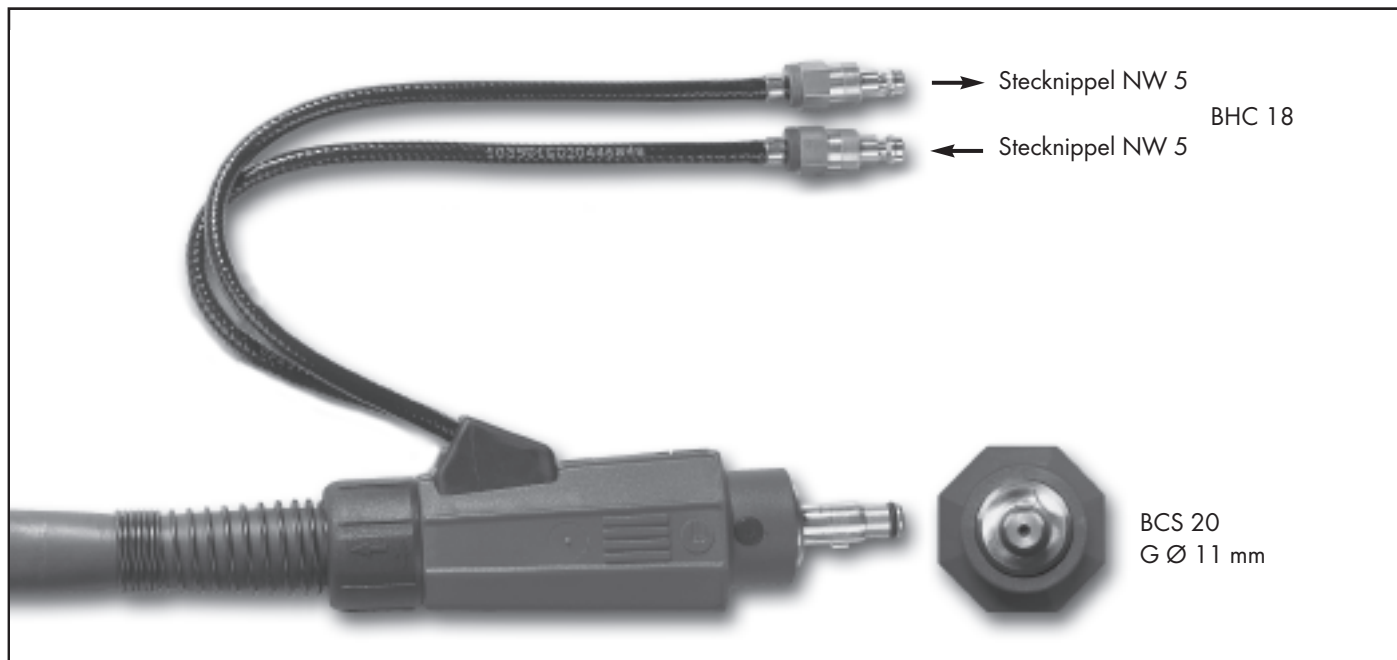

Brennertyp	Länge	maschinenseitiger Anschluss	Bestellnummer
ABITIG® 260 W MT	4 m	dalex BSB CG	7M510400- -20- - -18
	8 m	dalex BSB CG	7M510800- -20- - -18
ABITIG® 300 W MT*	4 m	dalex BSB CG	7M5V0400- -20- - -18
	8 m	dalex BSB CG	7M5V0800- -20- - -18
ABITIG® 400 W MT	4 m	dalex BSB CG	7M520400- -20- - -18
	8 m	dalex BSB CG	7M520800- -20- - -18
ABITIG® 500 W MT	4 m	dalex BSB CG	7M550400- -20- - -18
	8 m	dalex BSB CG	7M550800- -20- - -18

ABITIG®-Brennerpreisliste für MT Brenner (Automatenbrenner)

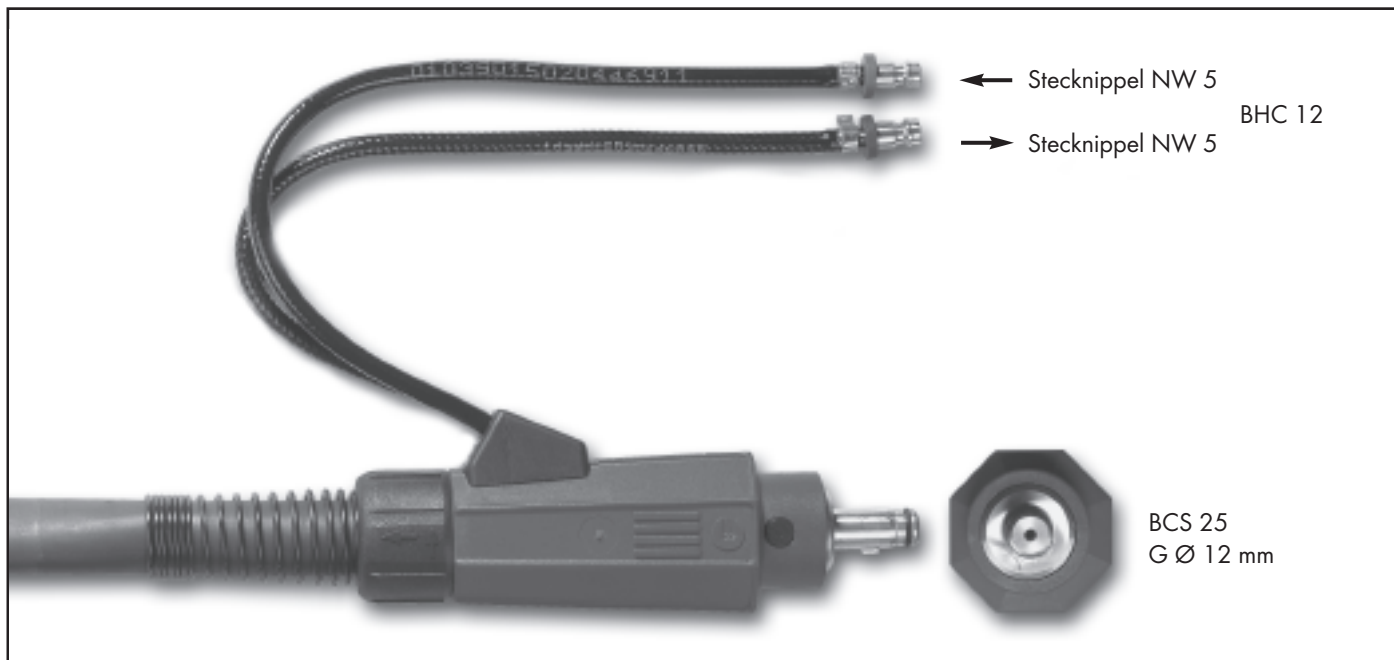

Brennertyp	Länge	maschinenseitiger Anschluss	Bestellnummer
ABITIG® 260 W MT	4 m	oerlikon BSB CG	7M510400- -25- - -12
	8 m	oerlikon BSB CG	7M510800- -25- - -12
ABITIG® 300 W MT*	4 m	oerlikon BSB CG	7M5V0400- -25- - -12
	8 m	oerlikon BSB CG	7M5V0800- -25- - -12
ABITIG® 400 W MT	4 m	oerlikon BSB CG	7M520400- -25- - -12
	8 m	oerlikon BSB CG	7M520800- -25- - -12
ABITIG® 500 W MT	4 m	oerlikon BSB CG	7M550400- -25- - -12
	8 m	oerlikon BSB CG	7M550800- -25- - -12

ABITIG®-Brennerpreisliste für MT Brenner (Automatenbrenner)

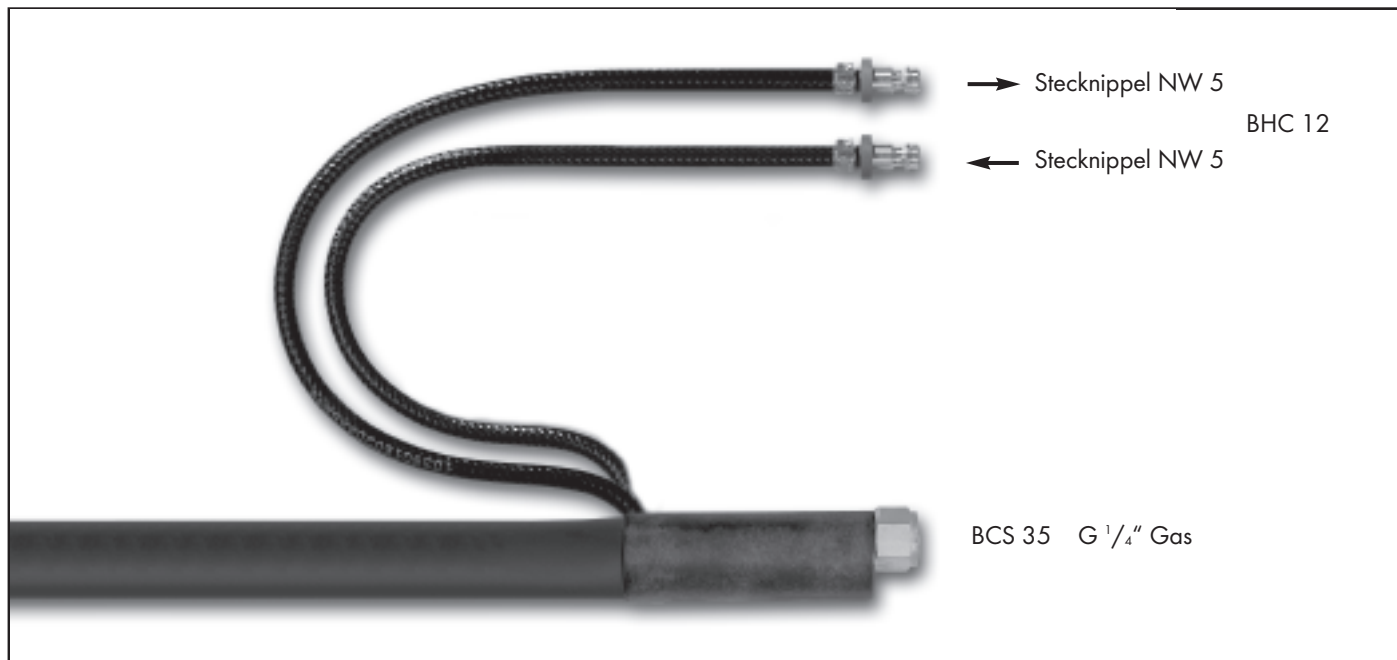

Brennertyp	Länge	maschinenseitiger Anschluss	Bestellnummer
ABITIG® 260 W MT	4 m	kemppi EA	7M510400- -35- - -12
	8 m	kemppi EA	7M510800- -35- - -12
ABITIG® 300 W MT*	4 m	kemppi EA	7M5V0400- -35- - -12
	8 m	kemppi EA	7M5V0800- -35- - -12
ABITIG® 400 W MT	4 m	kemppi EA	7M520400- -35- - -12
	8 m	kemppi EA	7M520800- -35- - -12
ABITIG® 500 W MT	4 m	kemppi EA	7M550400- -35- - -12
	8 m	kemppi EA	7M550800- -35- - -12

Technische Änderungen vorbehalten • Verkaufspreise = unverbindliche Preisempfehlung - Angebot freibleibend • © Copyright
* Abitig 300 mit voreinstellbarer Elektrode

ABITIG®-Brennerpreisliste für MT Brenner (Automatenbrenner)

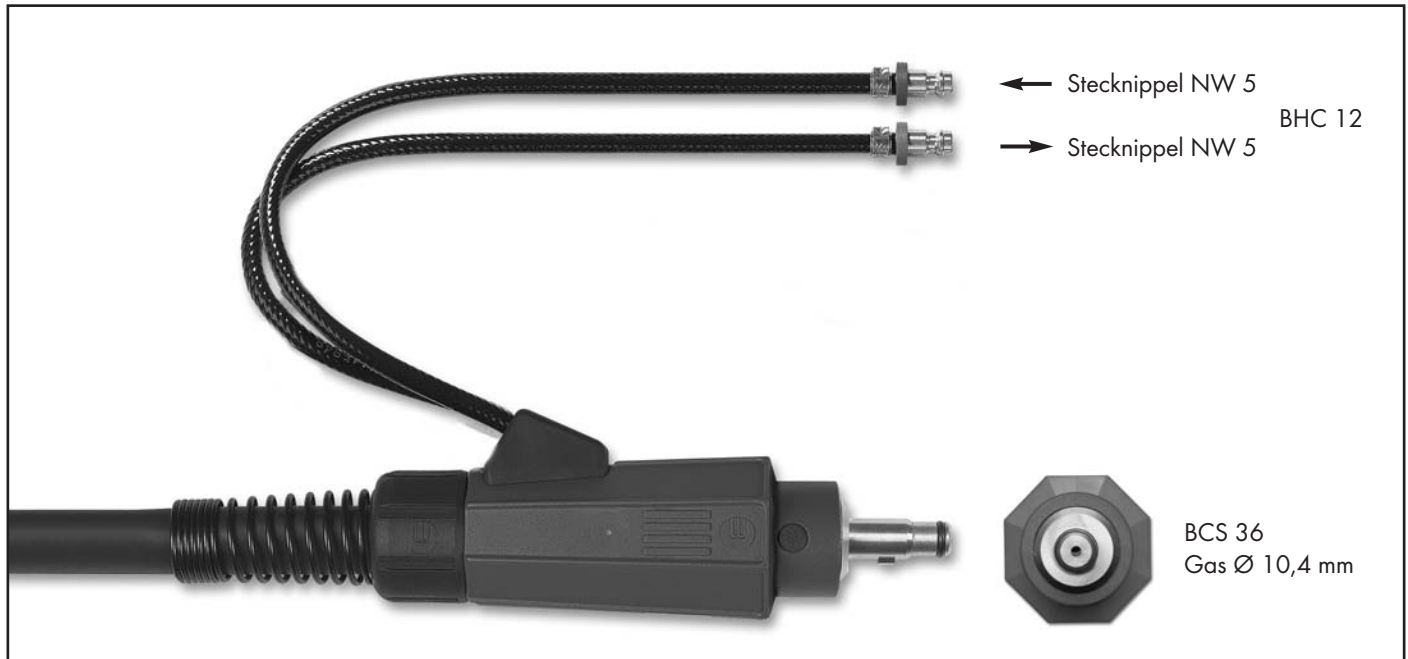

Brennertyp	Länge	maschinenseitiger Anschluss	Bestellnummer
ABITIG® 260 W MT	4 m	TTW Anschluss Fronius	7M510400- -36- - -12
	8 m	TTW Anschluss Fronius	7M510800- -36- - -12
ABITIG® 300 W MT*	4 m	TTW Anschluss Fronius	7M5V0400- -36- - -12
	8 m	TTW Anschluss Fronius	7M5V0800- -36- - -12
ABITIG® 400 W MT	4 m	TTW Anschluss Fronius	7M520400- -36- - -12
	8 m	TTW Anschluss Fronius	7M520800- -36- - -12
ABITIG® 500 W MT	4 m	TTW Anschluss Fronius	7M550400- -36- - -12
	8 m	TTW Anschluss Fronius	7M550800- -36- - -12

Technische Änderungen vorbehalten • Verkaufspreise = unverbindliche Preisempfehlung – Angebot freibleibend • © Copyright
* Abitig 300 mit voreinstellbarer Elektrode

ABITIG®-Brennerpreisliste für MT Brenner (Automatenbrenner)

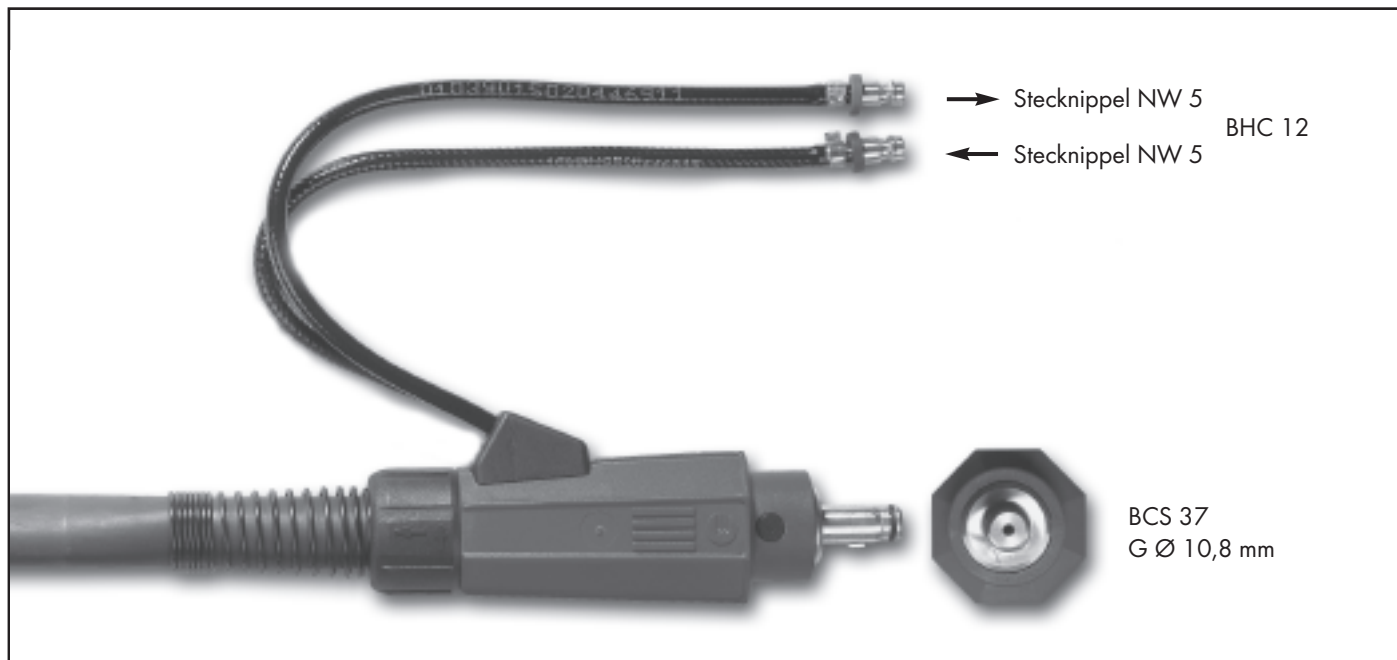

Brennertyp	Länge	maschinenseitiger Anschluss	Bestellnummer
ABITIG® 260 W MT	4 m	TCG Anschluss merkle	7M510400- -37- - -12
	8 m	TCG Anschluss merkle	7M510800- -37- - -12
ABITIG® 300 W MT*	4 m	TCG Anschluss merkle	7M5V0400- -37- - -12
	8 m	TCG Anschluss merkle	7M5V0800- -37- - -12
ABITIG® 400 W MT	4 m	TCG Anschluss merkle	7M520400- -37- - -12
	8 m	TCG Anschluss merkle	7M520800- -37- - -12
ABITIG® 500 W MT	4 m	TCG Anschluss merkle	7M550400- -37- - -12
	8 m	TCG Anschluss merkle	7M550800- -37- - -12

ABITIG®-Brennerpreisliste

Ventilbrenner



Brennertyp	Länge	Schalterfunktion	maschinenseitiger Anschluss	Schlauchpaketausführung	Bestellnummer
ABITIG® 9 V	4 m	Drehventil	Stecker 10 - 25	Standard	706.5057
	8 m	Drehventil	Stecker 10 - 25	Standard	706.5058
ABITIG® 17 V	4 m	Drehventil	Stecker 10 - 25	Standard	706.1057
	8 m	Drehventil	Stecker 10 - 25	Standard	706.1058
	4 m	Drehventil	Stecker 35 - 50	Standard	706.1037
	8 m	Drehventil	Stecker 35 - 50	Standard	706.1038
ABITIG® 17 FV	4 m	Drehventil	Stecker 10 - 25	Standard	706.1157
	8 m	Drehventil	Stecker 10 - 25	Standard	706.1158
	4 m	Drehventil	Stecker 35 - 50	Standard	706.1137
	8 m	Drehventil	Stecker 35 - 50	Standard	706.1138
ABITIG® 26 V	4 m	Drehventil	Stecker 35 - 50	Standard	706.4037
	8 m	Drehventil	Stecker 35 - 50	Standard	706.4038
ABITIG® 26 FV	4 m	Drehventil	Stecker 35 - 50	Standard	706.4137
	8 m	Drehventil	Stecker 35 - 50	Standard	706.4138

Allgemeine Liefer- und Leistungsbedingungen (Verkaufsbedingungen) der Alexander Binzel Schweisstechnik GmbH & Co. KG

§ 1 Geltung der Geschäftsbedingungen

- 1.1. Unsere sämtlichen Lieferungen, Leistungen und Angebote erfolgen ausschließlich aufgrund dieser allgemeinen Liefer- und Leistungsbedingungen (im Folgenden „diese Geschäftsbedingungen“). Diese Geschäftsbedingungen sind Bestandteil aller Verträge, die wir mit unseren Vertragspartnern (im Folgenden „Abnehmer“) schließen.
- 1.2. Allgemeine Geschäftsbedingungen des Abnehmers finden keine Anwendung, auch wenn wir ihrer Geltung im Einzelfall nicht gesondert widersprechen. Auch unter Bezugnahme auf ein Schreiben, das allgemeine Geschäftsbedingungen des Abnehmers oder eines Dritten enthält oder auf solche verweist, liegt kein Einverständnis mit der Geltung jener allgemeinen Geschäftsbedingungen vor. Diese werden auch nicht durch schlüssige Handlungen, wie beispielsweise die Erbringung einer Leistung durch uns, Vertragsbestandteil.
- 1.3. Diese Geschäftsbedingungen gelten für alle Verträge über Lieferungen und Leistungen unsererseits, sowie sämtliche Nebenleistungen. Auch ohne eine gesonderte Vereinbarung der Einbeziehung gelten diese Geschäftsbedingungen für alle zukünftigen Lieferungen und Leistungen unsererseits.

§ 2 Angebot und Vertragsschluss

- 2.1. Soweit unsere Angebote ausdrücklich als freibleibend gekennzeichnet sind, können wir diese auch nach Zugang der Annahme durch den Abnehmer unverzüglich widerrufen.
- 2.2. An von uns abgegebenen Angeboten, Kostenvoranschlägen, von uns oder Dritten stammenden, dem Abnehmer zur Verfügung gestellten Zeichnungen, Abbildungen, Berechnungen, Beschreibungen, Modellen, Werkzeugen und anderen Unterlagen und Hilfsmittel erwirbt der Abnehmer kein Urheberrecht. Dies gilt auch für solche der erwähnten Materialien und Unterlagen, die ausdrücklich als „vertraulich“ gekennzeichnet sind, oder deren vertraulicher Charakter sich aus den Umständen ergibt. Die Weitergabe der genannten Materialien und Dokumente an Dritte bedarf in jedem Fall unserer Zustimmung. Der Abnehmer hat dies durch entsprechende Vereinbarungen mit seinen Angestellten oder sonstigen Personen, die mit Wissen und Wollen in seinen Pflichtenkreis tätig werden, sicherzustellen. Die genannten Materialien und Unterlagen sind unverzüglich auf Kosten des Abnehmers zurückzugeben, soweit ein Vertrag nicht zustande kommt oder sie für die weitere Vertragsdurchführung nicht mehr benötigt werden.

§ 3 Preise

- 3.1. Sofern sich aus der Auftragsbestätigung nichts anderes ergibt, gelten unsere Preise „ab Werk“, ausschließlich Verpackung; diese wird gesondert in Rechnung gestellt.
- 3.2. Die gesetzliche Mehrwertsteuer ist nicht in unseren Preisen eingeschlossen. Sie wird in der vom Gesetz vorgegebenen Höhe am Tag der Rechnungsstellung in der Rechnung gesondert ausgewiesen. Bei Auslandsgeschäften entfällt die Mehrwertsteuer; der Empfänger hat jedoch die für den Transfer in das Empfängerland anfallenden Abgaben und Gebühren, insbesondere Zölle, und die darüber hinaus im Empfängerland selbst anfallenden gesetzlichen Abgaben oder Gebühren zu tragen.
- 3.3. Der Abzug von Skonto bedarf einer gesonderten Vereinbarung. Allgemeine Geschäftsbedingungen des Abnehmers, die den Abzug von Skonto vorsehen, gelten nicht.

§ 4 Ausführung der Lieferungen und Leistungen, Liefer- und Leistungszeiten

- 4.1. Sofern nichts anderes vereinbart ist, erfolgt die Lieferung „ab Werk“.
- 4.2. Der Beginn der von uns angegebenen Liefer- oder Leistungszeit setzt die Abklärung aller technischen Fragen voraus.
- 4.3. Die Einhaltung unserer Liefer- oder Leistungsverpflichtungen setzt weiter die rechtzeitige und ordnungsgemäße Erfüllung des Abnehmers voraus. Die Einrede des nicht erfüllten Vertrags steht uns in vollem Umfang zu.
- 4.4. Kommt der Besteller in Annahmeverzug oder verletzt er sonstige Mitwirkungspflichten, so sind wir berechtigt, den uns insoweit entstehenden Schaden einschließlich etwaiger Mehraufwendungen ersetzt zu verlangen. Weitergehende Ansprüche bleiben unberührt.
- 4.5. Soweit die Voraussetzungen von § 4 Abs. 4 vorliegen, geht die Gefahr eines zufälligen Untergangs oder einer zufälligen Verschlechterung der zu liefernden oder zu leistenden Sache in dem Zeitpunkt auf den Abnehmer über, in dem dieser in Annahmeverzug geraten ist.
- 4.6. Soweit mit dem Abnehmer vereinbart wurde, dass unsere Lieferung oder Leistung nicht zu einem festen Termin, sondern innerhalb eines bestimmten Zeitraums zu erfolgen hat, sind wir berechtigt, auch vor Ablauf des Zeitraums zu liefern oder unsere Leistung zu erbringen. Soweit mit dem Abnehmer ein fester Liefertermin vereinbart wurde, sind wir, nachdem wir dem Abnehmer eine angemessene Zeit vor Lieferung oder Erbringung der Leistung dies angezeigt haben, zur vorzeitigen Lieferung oder Erbringung der Leistung berechtigt. Dies gilt nicht, wenn aus für uns erkennbaren Gründen die Lieferung nur zu dem vereinbarten Termin erfolgen kann.
- 4.7. Sofern nichts anderes vereinbart ist, ist der Abnehmer bei solchen Verträgen, die ihn zum Abruf von Teillieferungen aus einer Gesamtmenge von Waren berechtigen, verpflichtet, uns rechtzeitige Abrufe und Sorteneinteilungen für un-gefähr gleiche Monatsmengen aufzugeben. Ruft der Abnehmer nicht rechtzeitig ab oder teilt er nicht rechtzeitig ein, so sind wir nach fruchtlosem Verstreichen einer angemessenen Nachfrist dazu berechtigt, die Einteilung selbst vorzunehmen und die Ware zu liefern.
Ruft der Abnehmer mehrfach nicht oder nicht rechtzeitig ab oder teilt er mehrfach nicht oder nicht rechtzeitig ein, so sind wir nach vorheriger Abmahnung berechtigt, vom gesamten Vertrag zurückzutreten. Die uns gesetzlich zustehenden Schadenersatzansprüche bleiben in jedem Fall unberührt.
- 4.8. Bei Abrufaufträgen nach § 4 Abs. 7 dieser Geschäftsbedingungen sind wir berechtigt, soweit keine abweichende Vereinbarung getroffen wurde, das Material für den gesamten Auftrag zu beschaffen und die gesamte Bestellmenge sofort herzustellen. Änderungswünsche des Abnehmers können nach Auftragserteilung nicht mehr berücksichtigt werden.
- 4.9. Handelsübliche Mehr- oder Minderlieferungen sind zulässig.

§ 5 Lieferverzögerung

- 5.1. Betriebsstörungen durch höhere Gewalt, nicht von uns zu vertretende Streiks oder Aussperrungen oder Betriebs- und/oder Rohstoffmangel berechtigen uns, vom noch nicht erfüllten Vertrag zurückzutreten, wenn die genannten Umstände die Lieferung oder Leistung nicht nur vorübergehend unmöglich machen und darüber hinaus bei Vertragsschluss nicht erkennbar waren.
- 5.2. Geraten wir mit einer Lieferung oder Leistung in Verzug oder wird uns eine Lieferung oder Leistung unmöglich, so ist ein Schadenersatzanspruch des Abnehmers nach Maßgabe des § 9 dieser Geschäftsbedingungen beschränkt.

§ 6 Erfüllungsort, Versand, Verpackung, Gefahrenübergang

- 6.1. Erfüllungsort für alle Verpflichtungen aus dem Vertragsverhältnis mit dem Abnehmer ist Buseck/Alten-Buseck.
- 6.2. Soweit nichts anderes vereinbart ist, werden wir die uns bekannte preisgünstigste Verpackung und die uns bekannte preisgünstigste Versandart wählen.
- 6.3. Die Gefahr geht spätestens mit Übergabe des Liefergegenstands an den Spediteur, Frachtführer oder das sonst zur Ausführung der Versendung bestimmte Unternehmen auf den Abnehmer über, soweit nichts anderes vereinbart ist. § 4 Abs. 4 bleibt unberührt.
- 6.4. Die Sendung wird von uns nur auf ausdrücklichen schriftlichen Wunsch des Abnehmers und auf seine Kosten gegen Diebstahl, Bruch, Transport-, Feuer und Wasserschäden oder sonstige versicherbare Risiken versichert.
- 6.5. Die Rücknahme von Verpackungen erfolgt ausschließlich in unseren Lagern (Rücknahmestellen). Die Kosten für den Transport von Verpackungen zu der jeweiligen Rücknahmestelle trägt der Abnehmer. Wird auf Wunsch des Abnehmers eine vom Standard abweichende Verpackung (Sonderverpackung) verwendet, ist der Abnehmer verpflichtet, diese auf eigene Kosten zu verwenden oder zu entsorgen.

§ 7 Ansprüche wegen Sachmängeln

- 7.1. Die von uns gelieferten Gegenstände sind unverzüglich nach Ablieferung an den Abnehmer oder an den von ihm bestimmten Dritten sorgfältig zu untersuchen. Sie gelten als genehmigt, wenn ein Mangel, der bei sorgfältiger Untersuchung zu entdecken gewesen wäre, nicht binnen drei Tagen nach Wareneingang schriftlich gerügt wird, wobei die Absendung der Rüge an uns entscheidend ist. War der Mangel bei der sorgfältigen Untersuchung nicht erkennbar, so gilt die Pflicht zur unverzüglichen schriftlichen Rüge ab dem Zeitpunkt der Entdeckung.
- 7.2. Soweit ein von uns zu vertretender Mangel der Lieferung oder Leistung vorliegt, sind wir nach unserer Wahl zur Mangelbeseitigung oder zur Ersatzlieferung verpflichtet. Im Fall der Mangelbeseitigung sind wir verpflichtet, alle zum Zweck der Mangelbeseitigung erforderlichen Aufwendungen, insbesondere Transport-, Wege-, Arbeits- und Materialkosten zu tragen, soweit sich diese nicht dadurch erhöhen, dass die Kaufsache an einen anderen Ort als dem ursprünglichen Versendungsort verbracht wurde. Dies gilt nicht, wenn das Verbringen an einen anderen Ort dem bestimmungsgemäßen Gebrauch des Liefergegenstands entspricht. Soweit wir die Nacherfüllung in Form der Nachlieferung wählen, sind die mangelbehafteten Liefergegenstände frachtfrei an uns zurückzusenden, wobei der Abnehmer verpflichtet ist, die preisgünstigste Versandart zu wählen.
- 7.3. Die Verjährungsfrist für Ansprüche wegen Sachmängeln beträgt ein Jahr und beginnt mit dem Zeitpunkt der Ablieferung beim Abnehmer oder einem vom Abnehmer bestimmten Dritten.
- 7.4. Die Lieferung gebrauchter Sachen erfolgt unter Ausschluss jeglicher Gewährleistung.

§ 8 Verbrauchsgüterkauf

§ 7 Abs. 3 gilt nicht, wenn die von uns gelieferten, neu hergestellten Gegenstände, auch im Rahmen einer Lieferkette, an Verbraucher veräußert werden.

§ 9 Schadenersatz

- 9.1. Wir haften – gleich aus welchem Rechtsgrund – nur für vorsätzliches und grob fahrlässiges Verhalten unserer Organe und Erfüllungsgehilfen sowie – ohne Rücksicht auf den Grad des Verschuldens – für Schäden aus der Verletzung des Lebens, des Körpers oder der Gesundheit.
- 9.2. Darüber hinaus haften wir auch für leichte Fahrlässigkeit unserer Organe und Erfüllungsgehilfen im Falle des Leistungsverzugs oder der Verletzung einer sonstigen Kardinalpflicht. In diesem Fall ist unsere Haftung auf solche Schäden beschränkt, mit denen wir bei Vertragsabschluss vernünftigerweise rechnen mussten.
- 9.3. Sämtliche Haftungsbeschränkungen gelten auch für den Fall, dass die Verletzung vertraglicher Pflichten zugleich eine unerlaubte Handlung darstellt.

§ 10 Eigentumsvorbehalt

- 10.1. Wir behalten uns das Eigentum an dem Liefergegenstand bis zum Eingang aller Zahlungen aus dem Liefervertrag vor. Bei vertragswidrigem Verhalten des Abnehmers, insbesondere bei Zahlungsverzug, sind wir berechtigt, nach fruchtlosem Verstreichen einer angemessenen Nachfrist den Liefergegenstand zurückzunehmen. In der Zurücknahme des Liefergegenstands durch uns liegt kein Rücktritt vom Vertrag vor, es sei denn, wir hätten dies ausdrücklich schriftlich erklärt. In der Pfändung des Liefergegenstands durch uns liegt stets ein Rücktritt vom Vertrag vor. Wir sind nach Rücknahme des Liefergegenstands zu dessen Verwertung befugt; der Verwertungserlös ist auf die Verbindlichkeiten des Abnehmers – abzüglich angemessener Verwertungskosten – anzurechnen.
- 10.2. Der Abnehmer ist verpflichtet, den Liefergegenstand für uns zu verwahren und pflichtig zu behandeln.
- 10.3. Bei Pfändungen oder sonstigen Eingriffen Dritter auf unsere Liefergegenstände hat uns der Abnehmer unverzüglich schriftlich zu benachrichtigen, damit wir Klage gemäß § 771 ZPO erheben können. Soweit der Dritte nicht in der Lage ist, uns die gerichtlichen und außergerichtlichen Kosten einer Klage gemäß § 771 ZPO zu erstatten, haftet der Abnehmer für den uns entstandenen Ausfall.
- 10.4. Der Abnehmer ist berechtigt, den Liefergegenstand im ordentlichen Geschäftsgang weiter zu verkaufen; er tritt uns jedoch bereits jetzt alle Forderungen in Höhe des Faktura-Endbetrages (einschließlich Mehrwertsteuer) unserer Forderung ab, die ihm aus der Weiterveräußerung gegen seine Abnehmer oder Dritte erwachsen, und zwar unabhängig davon, ob der Liefergegenstand ohne oder nach Verarbeitung weiterverkauft wird. Zur Einziehung dieser Forderung bleibt der Abnehmer auch nach der Abtretung ermächtigt. Unsere Befugnis, die Forderung selbst einzuziehen, bleibt hiervon unberührt. Wir verpflichten uns jedoch, die Forderung nicht einzuziehen, solange der Abnehmer seinen Zahlungsverpflichtungen aus den vereinnahmten Erlösen nachkommt, nicht in Zahlungsverzug gerät und insbesondere kein Antrag auf Eröffnung eines Insolvenzverfahrens gestellt ist oder Zahlungseinstellung vorliegt. Ist dies jedoch der Fall, so können wir verlangen, dass der Abnehmer uns die abgetretenen Forderungen und deren Schuldner unverzüglich bekannt gibt, alle zum Einzug erforderlichen Angaben macht, die dazugehörigen Unterlagen aushändigt und dem Schuldner (Dritten) sofort die Abtretung mitteilt und uns per Kopie/Anschieben darüber informiert.
- 10.5. Die Verarbeitung oder Umbildung des Liefergegenstands durch den Abnehmer wird stets für uns vorgenommen. Wird der Liefergegenstand mit anderen, uns nicht gehörenden Gegenständen verarbeitet, so erwerben wir das Miteigentum an der neuen Sache im Verhältnis des Werts des Liefergegenstands (Faktura-Endbetrag einschließlich Mehrwertsteuer) zu den anderen verarbeiteten Gegenständen zum Zeitpunkt der Verarbeitung. Für die durch die Verarbeitung entstehende Sache gelten im übrigen die gleichen Bedingungen wie für den unter Vorbehalt gelieferten Gegenstand.
- 10.6. Wird der Liefergegenstand mit anderen, uns nicht gehörenden Gegenständen untrennbar vermischt, so erwerben wir das Miteigentum an der neuen Sache im Verhältnis des Werts des Liefergegenstands (Faktura-Endbetrag einschließlich Mehrwertsteuer) zu den anderen vermischten Gegenständen zum Zeitpunkt der Vermischung. Erfolgt die Vermischung in der Weise, dass die Sache des Abnehmers als Hauptsache anzusehen ist, so gilt als vereinbart, dass der Abnehmer uns anteilmäßig Miteigentum überträgt. Der Abnehmer verwahrt das entstandene Alleineigentum oder Miteigentum für uns.
- 10.7. Wir verpflichten uns, die uns zustehenden Sicherheiten auf Verlangen des Abnehmers insoweit freizugeben, als der realisierbare Wert unserer Sicherheiten die zu sichernden Forderungen um mehr als 10% übersteigt; die Auswahl der freizugebenden Sicherheiten steht uns zu.

§ 11 Zahlungsbedingungen

- 11.1. Unsere Rechnungsbeträge sind innerhalb von 30 Tagen ohne jeden Abzug zahlbar, soweit nichts anderes vereinbart ist. Bei Ablauf dieser Frist kommt der Abnehmer in Verzug, ohne dass es einer Mahnung unsererseits bedarf.
- 11.2. Der Abnehmer ist zur Aufrechnung nur mit solchen ihm zustehenden Forderungen berechtigt, die rechtskräftig festgestellt oder unbestritten sind. Gleiches gilt für die Geltendmachung eines Zurückbehaltungsrechtes.

§ 12 Schriftform- und Schlussbestimmungen

- 12.1. Von diesen Geschäftsbedingungen abweichende Regelungen bedürfen der Schriftform. Dies gilt nicht für Regelungen, die mit Geschäftsführern oder Prokuristen unsererseits vereinbart werden.
- 12.2. Gerichtsstand für alle etwaigen Streitigkeiten aus der Geschäftsbeziehung zwischen uns und dem Abnehmer ist Gießen. Wir sind jedoch berechtigt, den Abnehmer auch an dessen allgemeinem Gerichtsstand sowie an dem Ort zu verklagen, an den der Liefergegenstand auf Wunsch des Abnehmers versandt wurde.
- 12.3. Alle Rechtsbeziehungen, die im Zusammenhang mit der Eingabe, Durchführung oder Beendigung dieses Vertrages entstehen, sind nach dem materiellen Recht der Bundesrepublik Deutschland unter Ausschluss des UN-Kaufrechts zu beurteilen. Dies gilt auch dann, wenn sie auf deliktischer oder sonstiger gesetzlicher Grundlage beruhen.



Unser Lieferprogramm:

■ MIG/MAG

- Schutzgas-Schweißbrenner
- Automaten- und Sonderbrenner
- Push-Pull-Brenner
- Rauchgas-Absaugbrenner
- Zentralstecker- und -buchsen-System

■ WIG

- Schutzgas-Schweißbrenner
- Automaten- und Sonderbrenner

■ PLASMA

- Schneidbrenner
- Schweißbrenner
- Automaten- und Sonderbrenner

■ Roboter-Peripherie

- Roboter-Brenner
MIG/WIG/Plasma
- Roboterhalterung CAT2
- Brennerhalswechselsystem
ATS-Rotor
- Werkzeugwechselsystem WWS
- Drahtabschneidevorrichtung DAV
- Brenner-Reinigungsstationen
BRS-LC und BRS-FP
- Drahtvorschubeinheit APD-MF

■ Schweißzubehör

- Wasserumlaufkühlgeräte
 - Schweißkabelstecker und -buchsen
 - Trennmittel, -spray und -paste
- u.a.m.



Alexander Binzel Schweisstechnik GmbH & Co. KG
 Postfach 10 01 53 · D-35331 Gießen
 Tel.: ++49 (0) 64 08 / 59-0
 Fax: ++49 (0) 64 08 / 59-191
 Internet: www.binzel-abicor.com
 E-Mail: info@binzel-abicor.com

www.binzel-abicor.com